

# BATTLEFORCE 2<sup>®</sup>

BATTLETECH WARFARE ON A GRAND SCALE

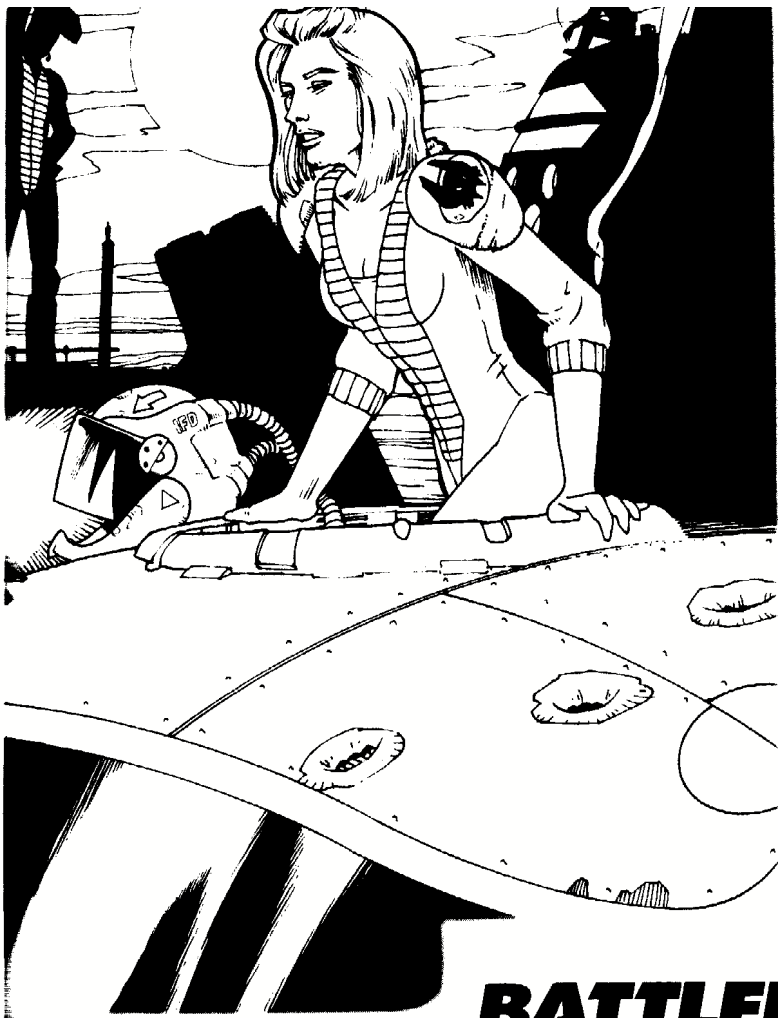

FASA  
CORPORATION



**BATTLEFORCE 2**  
BATTLETECH WARFARE ON A GRAND SCALE

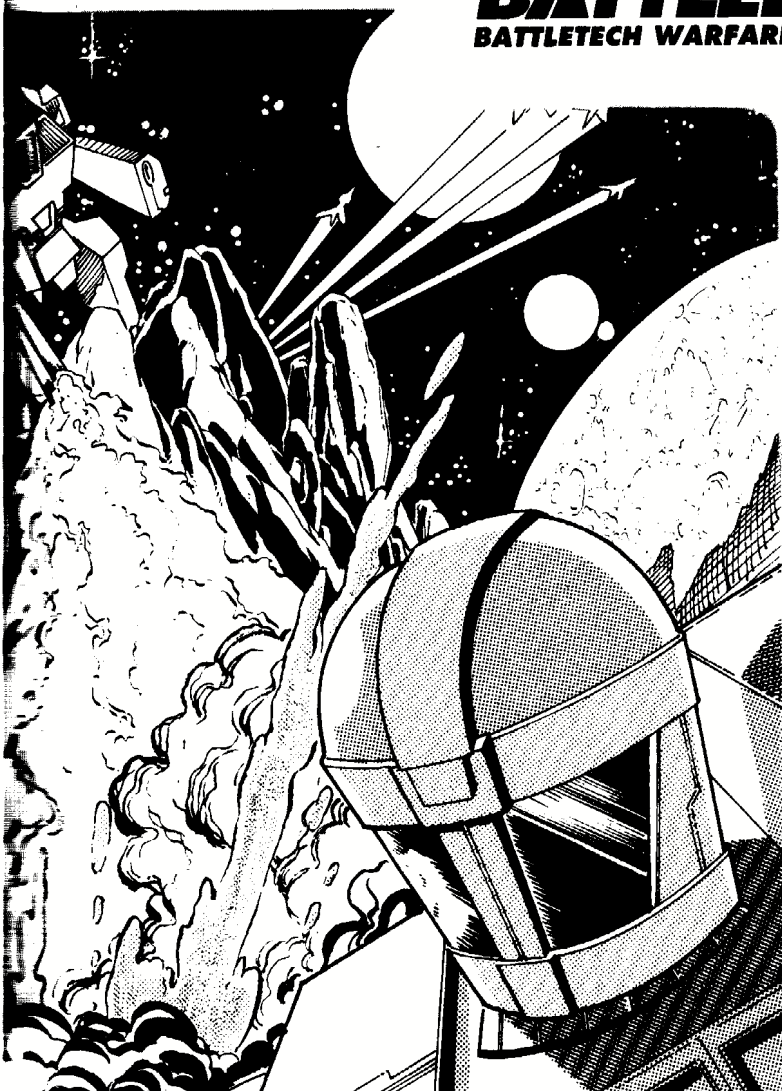

**FASA**  
CORPORATION

# BATTLEFORCE 2

## TABLE OF CONTENTS

<b>A TIME OF WAR</b>	4				
<b>INTRODUCTION</b>	5				
<b>Overview</b>	5				
BattleForce	5				
Planetary Assault	5				
Appendices	5				
<b>Components</b>	5				
Rulebook	5				
Counters	6				
Mapsheets	6				
Battle Board	6				
Inner Sphere Map	6				
Dice	6				
<b>Terminology</b>	6				
<b>Forces of the 31st Century</b>	6				
BattleMechs	6				
Ground Vehicles	7				
Air Vehicles	7				
Naval Vehicles	7				
Other Ground Units	7				
Aerospace Units	8				
<b>Military Organization</b>	9				
Inner Sphere Militaries	9				
Clan Militaries	10				
Com Guards	11				
Standard Formations	11				
<b>BATTLEFORCE</b>	13				
<b>Components</b>	13				
Counters	13				
Record Sheets	14				
Mapsheets	16				
<b>PLAYING THE GAME</b>	18				
<b>Setting Up</b>	18				
<b>Sequence of Play</b>	18				
Initiative Phase	18				
Player Phases	18				
End Phase	18				
<b>Scenarios</b>	18				
Setup	19				
Objectives	19				
Deployment	19				
Victory Conditions	19				
<b>MOVEMENT</b>	20				
<b>Movement Costs</b>	20				
Jumping	20				
Movement on Roads/Pavement	20				
<b>Facing</b>	21				
<b>Stacking</b>	21				
<b>COMBAT</b>	22				
<b>Line of Sight</b>	22				
<b>Firing Arcs</b>	22				
BattleMech Firing Arc	23				
Vehicle Firing Arc	23				
<b>Attack Declaration</b>	23				
Opponent's Record Sheets	23				
<b>Making the Attack</b>	23				
Base To-Hit Number	23				
Modified To-Hit Number	23				
To-Hit Roll	24				
<b>Damage</b>	25				
Overheating	25				
Attack Direction	25				
Recording Damage	26				
Critical Hits	26				
<b>COMMANDS</b>	27				
<b>Command Units</b>	27				
Chain of Command	27				
		<b>Placing Command Counters</b>	27		
		27			
		27			
		27			
		28			
		28			
		30			
		30			
		32			
		33			
		33			
		33			
		33			
		33			
		34			
		34			
		34			
		34			
		37			
		37			
		37			
		37			
		38			
		38			
		38			
		38			
		39			
		40			
		41			
		41			
		41			
		41			
		43			
		43			
		43			
		44			
		44			
		44			
		45			
		45			
		46			
		46			
		46			
		46			
		47			
		47			
		47			
		47			
		48			
		48			
		48			
		48			
		48			
		49			
		49			
		49			
		49			
		49			
		50			
		50			
		50			
		50			
		50			
		51			
		52			
		52			
		52			
		52			
		52			
		52			
		52			
		52			
		53			
		53			
		53			
		54			
		54			
		54			
		54			
		54			
		55			
		55			
		55			
		62			
		62			
		63			
		64			
		66			
		71			
		71			
		71			
		72			
		72			
		72			
		74			
		74			
		77			
		77			
		77			
		77			
		78			
		78			
		79			
		79			
		79			
		79			
		80			
		80			
		80			
		81			
		81			
		81			
		81			
		81			
		81			
		84			
		84			
		84			
		84			
		84			
		84			
		85			
		85			
		85			
		85			
		85			
		85			
		86			
		87			
		87			
		87			

# BATTLEFORCE 2

Attacking on the Move	87	APPENDICES	100
Combat in Space	88	Appendix I: BattleTech Conversion	100
<b>PLANETARY ASSAULT SCENARIOS</b>	<b>89</b>	Appendix II: BattleSpace Conversion	103
Basic Scenario	89	Appendix III: Integration	104
Forces	89	Appendix IV: Campaigns	106
Defender Setup	90	<b>TECHNICAL READOUT</b>	<b>110</b>
Attacker Setup	90	The BattleMech	110
Victory Conditions	90	Equipment	111
Advanced Scenarios	91	Inner Sphere BattleMechs	113
Raid	91	Clan OmniMechs	113
Extraction	92	Vehicles	114
Last Stand	92	Infantry	115
Larger-Scale Scenarios	94	Inner Sphere Aerospace Fighters	115
Additional Counters	94	Clan Aerospace Fighters	116
Large-Scale Play	94	DropShips	116
<b>PLANETARY ASSAULT SCENARIO:</b>		WarShips	117
<b>THE FALL OF TERRA</b>	<b>95</b>	JumpShip	117
		Space Station	117
		<b>BATTLEFORCE ROSTER</b>	<b>118</b>

## CREDITS

### Design and Writing

Bryan Nystul

#### *Based on BattleTech by*

Jordan K. Weisman

L. Ross Babcock III

Sam Lewis

#### *With scenarios by*

Chris Hartford

Loren L. Coleman

### Project Development

Bryan Nystul

#### *Development Assistance*

Randall N. Bills

### Project Editing

Diane Piron-Gelman

Sharon Turner Mulvihill

### BattleTech Line Developer

Bryan Nystul

### Editorial Staff

*Editorial Director*

Donna Ippolito

*Managing Editor*

Sharon Turner Mulvihill

*Associate Editor*

Diane Piron-Gelman

### Production Staff

*Art Director*

Jim Nelson

*Cover Art*

Doug Chaffee

### Cover Design

Jim Nelson

### Illustrations

Doug Chaffee

Mike Chen

Scott James

John Paul Lona

Roger Peterson

Matthew Plog

Loston Wallace

### Layout

John Bridegroom

### Playtesters

David Abelt, Randall N. Bills, Loren L. Coleman, Frank Crull,

Michael DeHoyas, Christopher Errett, Dan "Flake" Grendell,

Craig S. Gullede, Chris Hartford, Lewis Helfer, Scott A. Hensch,

Duri Price

#### *The AGP Headhunters*

Dave Brown, Brian Gruber, John Kielman, Eric Larson,

Gary Larson, Andrew Lichey, Joe Lutovsky, Rick Seidl, Chris Smith

Christoffer "Bones" Trossen

#### *Group W*

Andrew Bethke, James W. Moorman, Jr., Robert G. Kranker,

Edward C. Witzlib, Gregory Plambeck

### Special Thanks To:

The designers of the original **BattleForce** game: L. Ross Babcock III, Cory Glaberson, Kevin Stein and Jordan K. Weisman.

Dan "Flake" Grendell, for action far above and way beyond the call of duty. Just one more fighter to convert!

The FASA art boyz and the fantastic artists who made my chicken-scratch game look really *cool*.

My big brother Mike, for listening to me rant. You're the greatest, dude!

And finally, my parents, Brad and Genny Nystul, to whom I dedicate this product. While other kids' folks were condemning gaming, you guys were playing right alongside me. Thanks for everything.

BATTLEFORCE®, BATTLETECH®, BATTLEMECH®, MECH®, and MECHWARRIOR® are Registered Trademarks of FASA Corporation. Copyright © 1997 FASA Corporation. All Rights Reserved.

Printed in Canada

Published by FASA Corporation 1100 W. Cermak Road • Suite B305 Chicago, IL 60608

FASA Corporation can be reached on America OnLine (E-mail: FASALou (Earthdawn), FASAInfo (BattleTech, Shadowrun and General Information) or FASA Art (Art Comments)) in the Online Gaming area (Keyword "Gaming"). Via InterNet use <AOL Account Name>@AOL.COM, but please, no list or server subscriptions. Thanks!

Visit our World Wide Web site at <http://www.FASA.com>

## A TIME OF WAR

It is the year 3059. Mankind inhabits the stars, but has taken his warlike nature with him. The thousands of worlds radiating out from Sol, first sun of the human race, were once bound together in a Star League that fostered technology, expansion and prosperity for all. With the fall of the League in 2781, a Dark Age descended as each of the five surviving star empires began warring for dominion. To this day, almost three centuries later, none of the five Successor Lords has triumphed decisively to become supreme Lord over the others.

The leaders of these five great star empires are known today as the Successor Lords of Houses Davion, Kurita, Steiner, Liao and Marik. The devastating battles they have fought among themselves almost continuously for nearly three hundred years came to be called the Succession Wars.

To fight these wars, the Successor Lords used armies of BattleMechs: gigantic, vaguely humanoid battle machines bristling with lasers, particle projection cannons, long- and short-range missile launchers, autocannons and machine guns. These walking tanks ruled the battlefields, while intrigue and plots ruled the courts of the Inner Sphere as each ruler sought to win by deceit what he could not achieve through force.

That bloody history appeared to change when Prince Hanse Davion of the Federated Suns married Melissa Steiner, heir to the Lyran Commonwealth. Though the marriage triggered the Fourth Succession War, that cruel conflict seemed to be the last gasp of a dying age of civil war in the Inner Sphere. The union of the Successor States' strongest military and economic powers created the Federated Commonwealth, a vast new realm possessing the potential power to found a new Star League. With the birth of Prince Victor Steiner-Davion, the first child of the Steiner-Davion dynasty, the historic Federated Commonwealth seemed destined to light the way toward a new and blessed unity among the star-spanning empires of the war-torn Inner Sphere ... until Fate intervened.

Even as the first generation of Steiner-Davions grew to adulthood, apocalypse was approaching. Beyond the Periphery, the boundary of known space, a people born and bred to war prepared to launch an invasion that would crush the Inner Sphere, and the dreams of a Steiner-Davion Star League with it.

In 3049, an unknown enemy attacked the Free Rasalhague Republic, using BattleMechs of awesome destructive power. The invaders took world after world, conquering nearly all of the Republic in brutal, lightning strikes. Frightened citizens believed them to be a race of alien barbarians, come to conquer humanity. The unknown marauders had indeed come to conquer humanity, but they were not aliens. They were the Clans, warrior descendants of the legendary Aleksandr Kerensky's vanished Star League Army. Kerensky's children had returned to the Inner Sphere, to purify it with fire and sword.

As the terrified Successor States banded together to fight an apparently invincible enemy, ComStar's Precentor Martial Anastasius Focht bargained with ilKhan Ulric Kerensky of the Clans for an all-or-nothing contest on the planet Tukayyid. A Clan victory would net them a glittering prize: humankind's homeworld of Terra. If ComStar won, the Clans agreed to halt their invasion for fifteen years.

The battle, fought over several days in the spring of 3052, was a victory for ComStar's soldiers and the Inner Sphere—but at a high price. In the ensuing few years, many leaders among the Successor States made the mistake of believing that the stopgap victory on Tukayyid had vanquished the Clans forever. Lacking a common enemy, they reverted to bickering and bloodletting, ignoring the powerful enemy still poised on their fragile borders. Meanwhile, a new generation of Clan warriors was coming of age, who had no intention of allowing a truce sworn with the "dishonorable barbarians" of the Inner Sphere to prevent them from earning glory on the battlefield. With feinting raids across the truce line and political maneuverings among their fellow Clans, Clan Jade Falcon—historically among the fiercest rivals of Ulric Kerensky's Clan Wolf—led the charge to break the Truce of Tukayyid and resume the drive toward Terra.

The simmering dissent among the Clans boiled over in mid-3057 in a titanic battle between Clans Wolf and Jade Falcon known as the Refusal War. That conflict ended with Khan Ulric Kerensky dead, both Clans decimated, and Clan Wolf split into two factions: a newly aggressive Clan Wolf under Khan Vlad Ward, and the Wolf-Clan-in-Exile, under the leadership of Kerensky's protégé, Khan Phelan Kell, devoted to safeguarding the Inner Sphere from devastation at the hands of its erstwhile fellow Clans.

Meanwhile, all is far from well in the Inner Sphere. Archon Prince Victor Steiner-Davion of the Federated Commonwealth battles the invasion of his realm by Liao and Marik forces, but with only half his empire's strength—Katherine Steiner-Davion, ruler of the Lyran worlds, has torn them away from her brother's grasp and created the independent Lyran Alliance. The Capellan Confederation and the Free Worlds League are taking world after Commonwealth world, and Victor can do little to stop them.

The upheaval has even touched the heart of known space. The Word of Blake, a ComStar splinter group fanatically devoted to remaining a mystic order with unquestioned power over vital communications technology, has cast its ComStar rivals off of Terra. On Commonwealth worlds near Terra, the Marik-Liao onslaught and the secession of the Lyran Alliance has blown the lid off simmering hatred between countless factions, and vultures squabble over the scraps of power while ordinary people suffer. The so-called Chaos March is a no-man's land, where the fighting never stops and loyalty can mean death. And the breaking of the Truce of Tukayyid grows closer every day; with the old Clan Wolf's tempering influence gone, the pro-invasion Crusaders among the Clans have the power as well as the will to destroy the Inner Sphere.

The Successor States' only hope for survival lies in taking the war to their Clan enemy. Theodore Kurita, Coordinator of the Draconis Combine, has been working with ComStar's Explorer Corps to quietly gather the Inner Sphere's finest mercenary units and send them out to search for the hidden Clan homeworlds. This long-shot gambit has finally succeeded, and the Inner Sphere now stands ready carry the war to the Clans' doorstep. An Inner Sphere task force, under the banner of a new Star League, prepares to set out on the epic journey that may yet save the Inner Sphere from destruction ... if its forces can survive.

# BATTLEFORCE 2

## A NOTE TO BATTLETECH PLAYERS

**BattleTech** is a small-scale game, designed to support from four to fifteen units per side. Games larger than this are certainly possible, but can take several days to complete, even in the hands of experienced players. In a large-scale game, the movement of battle lines and control of key areas of the battlefield are more important than the specifics of hit locations and critical damage common to **BattleTech** play. The minute details involved in record-keeping for each 'Mech can bog down play, distracting players from the overall goal of such a large-scale game.

In order to work as a mass-combat version of **BattleTech**, **BattleForce** needed to be much faster to play, so that each player could comfortably command a battalion of troops or more. However, we decided early on that the individual 'Mech should still be a factor on the battlefield, so that your *Atlas* or *Mad Cat* can blast away at your opponent just like it can in standard **BattleTech**. To keep individual 'Mechs and vehicles distinct at a such a large scale while still making the game fast enough to finish quickly required an abstraction of standard **BattleTech** rules and forces, reducing each 'Mech from a complex record sheet down to six numbers. However, we made every effort to keep each BattleMech's abilities faithful to **BattleTech**. The system we devised allows any 'Mech, even your own custom designs, to participate in massive-scale campaigns with their abilities and MechWarriors intact. If the loss of detail needed to accomplish the changes seems strange or even wrong, rest assured that all such omissions arose from necessity, and that everything has been done with the goal of creating a fun, fast-paced, yet tactically challenging game.

## INTRODUCTION

**BattleForce 2** simulates grand-scale combat in the **BattleTech** universe. This is your chance to command an entire army in futuristic combat on distant planets. Every kind of weapon available to a thirty-first-century general is at your disposal, including tanks, hovercraft, helicopters, infantry, artillery and the thirty-foot tall humanoid juggernauts called BattleMechs, the most powerful and versatile weapons of war ever devised. At your command, any size battlefield from a single town to an entire planet will fall beneath the crushing feet of your 'Mechs.

### OVERVIEW

**BattleForce 2** consists of three major parts: the games of **BattleForce** and **Planetary Assault**, as well as various **Appendices** useful for game play.

### BATTLEFORCE

**BattleForce**, the main game in this boxed set, quickly and easily recreates large-scale ground combat in the **BattleTech** universe. Each side can field an entire battalion or regiment and still expect to finish the game in a single evening.

Each unit on the map represents a lance of 'Mechs or vehicles, or a company of infantry. However, each individual 'Mech and vehicle within each lance is still a distinct force on the battlefield, with its own armor and attack ratings that reflect its unique abilities. These ratings are vastly simplified from their **BattleTech** counterparts in the interest of speeding up game play and record-keeping, but still maintain the individual character of each 'Mech, vehicle or platoon.

### PLANETARY ASSAULT

The second game, **Planetary Assault**, puts you in charge of an entire planetary assault or planetary defense. The map represents a world rather than a single smaller battlefield; you decide where your DropShips will land, what objectives your 'Mechs will seize and how your supplies will reach the front lines.

This scale of play is even further abstracted from standard **BattleTech** than **BattleForce**, so that each unit represents a company or other large operational unit. At this scale, each turn represents two days, and units must cross thousands of kilometers to reach their objectives: the cities and industrial centers that represent the key to controlling a planet. Each individual combat is less important than the overall grand plan, so games will be won or lost by the strategic placement of your battle lines and the effective use of supplemental forces such as aerospace fighters and infantry.

### APPENDICES

The rules for **BattleForce** and/or **Planetary Assault** allow you to resolve large-scale campaigns for **BattleTech** quickly and simply. The appendices include rules for converting **BattleTech** units to **BattleForce 2** units so that players can use even custom-made 'Mechs and vehicles in a large-scale assault, as well as rules for converting damage sustained in large-scale battles to **BattleTech** scale for repairs and salvage after the game. The appendices also provide rules for integrating **BattleTech**, **BattleSpace**, **BattleForce** and **Planetary Assault** into even larger-scale campaigns using fixed forces on each side.

Finally, the appendices include record sheets and force lists for **BattleForce**.

### COMPONENTS

The **BattleForce 2** box contains everything you need to play **BattleForce** and **Planetary Assault**. Nothing from the **BattleTech** game is required, nor is knowledge of standard **BattleTech** rules needed in order to play these games.

### RULEBOOK

The rulebook is the volume you are reading now. It includes rules for **BattleForce** and **Planetary Assault**, as well as rules for integrating **BattleTech** and **BattleSpace** with your **BattleForce 2** games. Force lists and record sheets for **BattleForce** appear at the back of this book. You may photocopy these documents for your personal use.

# BATTLEFORCE 2

## COUNTERS

The game includes four sheets of counters, two for each player. Though the illustrations on many of them represent Inner Sphere or Clan forces, the players need not play only Clan vs. Inner Sphere battles. Players who wish to can play Inner Sphere vs. Inner Sphere, or Clan vs. Clan. (For a fuller description of counters and how to use them, see **BattleForce**, p. 13.)

## MAPSHEETS

**BattleForce 2** includes four mapsheets. Two of them depict a standard assortment of terrain for use in the **BattleForce** game. These mapsheets can be used with **BattleTech**, just as any **BattleTech** mapsheets can be used when playing **BattleForce**.

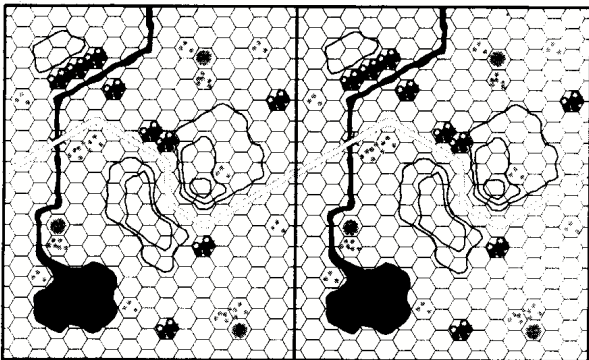

The other two mapsheets are joined together to form the playing area for the **Planetary Assault** game. The front (color) side of the mapsheets depicts our own planet Earth, known as Terra in **BattleTech**. The back is a blank planetary map where you can draw your own new worlds to conquer.

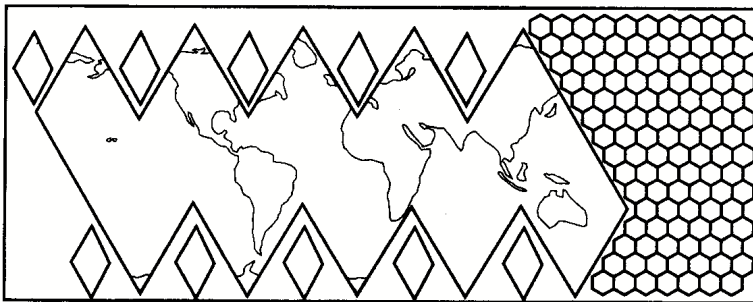

## BATTLE BOARD

The 8 1/2" x 11" battle board has two sides. The Support Map side is used in the **BattleForce** game to regulate movement of off-board units. The Battle Board side is used to resolve combat in the **Planetary Assault** game.

## INNER SPHERE MAP

A poster-sized map of the Inner Sphere of 3059 has been included as a bonus to help armchair field marshals plan their multi-planet campaigns.

## DICE

Both **BattleForce 2** games are played using the two standard six-sided dice included in the box. Throughout the rules, rolling one die is referred to as a D6 roll; rolling both dice and adding together the numbers rolled for the result is referred to as a 2D6 roll.

## TERMINOLOGY

In these rules, the term *unit* applies to individual counters on the map, which represent formations such as lances, Stars and infantry platoons. Each unit moves individually on the map.

In order to avoid confusion, these rules use the term *formation* when referring to groups such as companies, battalions and so on. In this game, it is important to know which formation each unit belongs to, and which units are command units.

## FORCES OF THE 31ST CENTURY

The armies of the thirty-first century consist of numerous diverse elements that offer a wide range of abilities: BattleMechs, ground vehicles, air and naval vehicles, infantry troopers and aerospace fighters. The winning general knows what each element in each of his units can do.

## BATTLEMECHS

BattleMechs—the most powerful war machines ever built—dominate the battlefields of the thirty-first century. These huge, man-shaped machines are faster, more maneuverable, better armored and more heavily armed than any other combat element. Equipped with particle projection cannons, lasers, rapid-fire autocannons and missiles, these behemoths pack enough firepower to flatten everything but another 'Mech.

Armies of the thirty-first century field two classes of BattleMechs: those used primarily by the Inner Sphere, which represent variations of and improvements on the original 'Mech technology, and the unique machines known as OmniMechs that give the Clans their edge in combat. Both BattleMechs and OmniMechs are classified as Light, Medium, Heavy or Assault.

### Light 'Mechs

Light 'Mechs range in weight from 20 to 35 tons. On the battlefield, light 'Mechs serve most often in reconnaissance roles. Their above-average speed and jump capability makes them well-suited to efficiently avoid heavy fighting while maneuvering to assess enemy troop formations. Despite their many assets, however, light 'Mechs cannot stand against heavier units, even with the advantage of numerical superiority.

### Medium 'Mechs

The workhorses of the armies of the Inner Sphere, medium BattleMechs range in weight from 40 to 55 tons. On the battlefield, medium 'Mechs form the core of almost every formation. While light 'Mechs scout out battlefield terrain and enemy

# BATTLEFORCE 2

forces, medium 'Mechs wade in and slug it out with opposing troops until the heavy and assault units arrive.

## Heavy 'Mechs

Heavy 'Mechs weigh from 60 to 75 tons. Usually piloted by commanders and experienced MechWarriors, they play a major role on the battlefields of the Inner Sphere. Heavy 'Mechs can dish out and take immense amounts of damage, and so only another heavy or an assault 'Mech can normally take on a typical heavy BattleMech.

## Assault 'Mechs

Assault 'Mechs, weighing from 80 to 100 tons, are the kings of the thirty-first-century battlefield. So fearsome are these behemoths in battle that one assault 'Mech is often equal to an entire lance of lighter 'Mechs. A well-designed assault 'Mech fears no opponent in the field, and its physical attacks can cripple nearly any target.

## GROUND VEHICLES

Despite the power and tactical flexibility of the BattleMech, conventional ground vehicles such as tanks and hovercraft are still used extensively by thirty-first-century armies because of their low cost and ease of repair.

### Light Vehicles

Light vehicles weigh anywhere from 5 to 35 tons. Primarily used for reconnaissance, the light vehicle is almost exclusively designed for speed. Though tracked and wheeled light vehicles exist on the battlefield, hovercraft—with their greater speeds—dominate this weight class.

### Medium Vehicles

Medium vehicles weigh from 40 to 55 tons. Used as skirmishers, medium vehicles are employed by the various House militaries of the Inner Sphere to harass and pin down an enemy until heavier forces can be brought to bear.

### Heavy Vehicles

Heavy vehicles range in weight from 60 to 75 tons. Mirroring the medium 'Mech weight class, heavy vehicles are the workhorse vehicle of all Successor State armies. Packing a serious punch, with armor to match, a heavy vehicle can stay in the fight longer than some light 'Mechs.

### Assault Vehicles

Assault vehicles weigh from 80 to 100 tons. Though they lack the mobility of their 'Mech counterparts, the sheer volume of firepower that an assault vehicle carries can be the downfall of even a heavy 'Mech if the MechWarrior piloting it is not cautious.

### Armored Personnel Carriers

Armored personnel carriers (APCs) form a key component of any vehicular military formation. By giving a commander the ability to rapidly re-deploy his infantry and thereby counter unexpected moves by the enemy, APCs give a military unit a vital factor in achieving victory—flexibility.

## AIR VEHICLES

Though largely eclipsed by their flashier, more powerful replacement, the aerospace fighter, air vehicles—VTOLs and air transports—nonetheless provide a tactical edge in battle that any commander can exploit. Despite being relegated to reconnaissance and troop ferrying, they remain a valuable asset in any military force.

### VTOLs

Fast, deadly and highly vulnerable to damage, VTOLs and their pilots suffer the highest mortality rate of any type of combat vehicle. The term VTOL refers to a variety of vertical take-off and landing vehicles whose primary mission is to support the battle on the ground, including conventional rotary-wing craft (helicopters), X-wing “stopped rotors” craft and tilt-rotor aircraft (whose engine mountings rotate in a 90-degree arc). Because of the high torque required for their operation, VTOL rotors cannot be heavily armored and so cannot absorb much combat damage. More VTOLs are destroyed by rotor hits than by any other type of damage.

### Air Transports

Air transports fill a role almost identical to that of APCs. Despite being fragile and cumbersome, air transports take troop ferrying to the next level of flexibility, giving a commander the ability to insert troops into almost any location desired and under any conditions.

## NAVAL VEHICLES

Large-tonnage military naval vessels long ago gave way to conventional and aerospace fighters, with their demonstrated battlefield superiority. However, small naval vessels still perform counterinsurgency work and defend underwater command posts.

### Naval Transports

Slow by nature and restricted to water, naval transports have severe limitations when compared with more flexible ground and air transports, making them logistically impractical for offensive campaigns. However, in a defensive campaign, a naval transport can ferry massive quantities of equipment and troops.

### Submarines

Over the past several centuries, technological advances have allowed manufacturers to create ever-smaller submarines, and these underwater vessels still reign supreme in the oceans of most worlds. In their home environment, these expensive and specialized vessels can reasonably expect to defeat an equivalent-weight BattleMech. Commanders usually assign them to protect underwater installations and command centers.

## OTHER GROUND UNITS

Various other ground units make up the final composition of any military. Though generally overlooked, these units provide the final elements that can guarantee a commander victory.

### Standard Infantry

Despite the massive power of BattleMechs as weapons of war, the humble infantry trooper remains the backbone of every military force in the thirty-first century. In fact, many poorer planets rely for defense on garrisons comprised entirely of infantry.



# BATTLEFORCE 2

## **Battle Armored Infantry**

Battle-armored infantrymen wear powered suits of armor equipped with various weapons. Though some Inner Sphere units field battle-armored troops, such equipment is not yet common and is less powerful than the Clan equivalent. Clan infantrymen, known as Elementals, are organized into 5-man Points. Their individually powered suits of armor mount missiles, small lasers and anti-personnel weapons. Because Elemental armor can survive direct hits from BattleMech-class weapons, a single Point of battle armor can efficiently disable or destroy a 20-ton 'Mech.

## **Artillery**

The ability to direct massive firepower at any given target has always been the goal of modern warfare. Artillery gives an army this capability. Combined with the psychological edge that artillery brings—the ability to strike an enemy with impunity—the intelligent use of this battlefield asset can bring a commander quick victory.

## **Headquarters**

Headquarters act as the nerve center of any large-scale military action. Information gathered by the disparate parts of a military unit are collected and processed by sophisticated computers at the HQ, which then present the data to the commander for analysis. This allows a commander to have all pertinent information when making vital, rapid decisions.

## **AEROSPACE UNITS**

Aerospace units enable a ground force to travel from its home star system to an enemy star system with the intent of attacking an enemy force. Each of the following units forms a vital link in this process.

The Clans field aerospace fighters known as OmniFighters, which they construct using the superior modular technology that their OmniMechs employ. Like Inner Sphere fighters, OmniFighters are classified as light, medium and heavy.

### **Light Fighters**

Light fighters weigh 20 to 45 tons. Their incredible speed and agility enables them to fill a variety of roles, from reconnaissance to surgical strikes to dogfights. The first to deploy and the last to return to base, the light fighter is the workhorse of aerospace fighters.

### **Medium Fighters**

Ranging in weight from 50 to 70 tons, the medium fighter specializes in dogfights. Though flexible enough to fill multiple combat roles, the heavy fighter excels at attacking and defeating an enemy's air support.

### **Heavy Fighters**

Heavy fighters weigh from 75 to 100 tons. Too large and cumbersome for dogfights, the heavy fighter can be equally well employed as a long-range bomber or as an escort for DropShips. Additionally, their superior armor and firepower enable heavy fighters to attack DropShips and WarShips, where protection and firepower rather than speed and agility are the key to victory.

## **Small DropShips**

Small DropShips are employed during small-unit actions. The small DropShip can be used to quickly insert or re-deploy forces—a company of infantry or a lance of 'Mechs or vehicles—when a long distance must be covered quickly. A typical example of this type of DropShip is the *Leopard Class DropShip*.

## **Medium DropShips**

The mainstay of any naval fleet, the medium DropShip can be found in every navy in the Inner Sphere and also among the Clans. The medium DropShip provides every military with the ability to transport significant assets to any target. A typical example of this type of DropShip is the *Union Class DropShip*.

## **Large DropShips**

Large DropShips enable a military to transport massive quantities of assets and personnel between the stars. With only three or four of these monstrous ships needed to transport an entire regiment of troops, they are primarily employed in planetary assaults. A typical example of this type of DropShip in the *Overlord Class DropShip*.

## **Assault Ships**

Inner Sphere militaries employ the massive assault DropShips to destroy enemy DropShips before they can land and disembark their troops. Exceptionally powerful, some Clan assault ships pack enough firepower to threaten small WarShips. A typical example of this type of DropShip is the *Avenger Class DropShip*.

## **JumpShips**

JumpShips provide the only means of transportation between the far-flung star systems of the Inner Sphere, the Periphery and beyond. These vessels make interstellar leaps of 30 light-years at a time by harnessing the radiant energy of the stars with their huge solar-energy sails and Kearny-Fuchida hyperdrive technology. JumpShips are primarily used to transport fusion-powered DropShips, the preferred method for interplanetary travel in the thirty-first century.

## **Small WarShips**

Small WarShips mass less than 750,000 tons. These armed and armored JumpShips normally serve as escorts, providing protection for JumpShip and DropShip fleets. Many commanders also employ them as strategic assets, allowing them to accompany DropShips all the way to the destination planet. Upon arrival, they establish a geosynchronous orbit that allows them to react to enemy troop movement on the ground with tactical orbital bombardments, or to the threat of incoming reinforcements.

## **Large WarShips**

Large WarShips mass from 750,000 to a mammoth 2,500,000 tons—though no known WarShip has exceeded 2,000,000 tons, despite the theoretical possibility of constructing larger ships. Currently, the largest WarShip ever built is the *McKenna Class*, which masses a colossal 1,930,000 tons. Rumor has it that the Clans have recently christened a new

# BATTLEFORCE 2

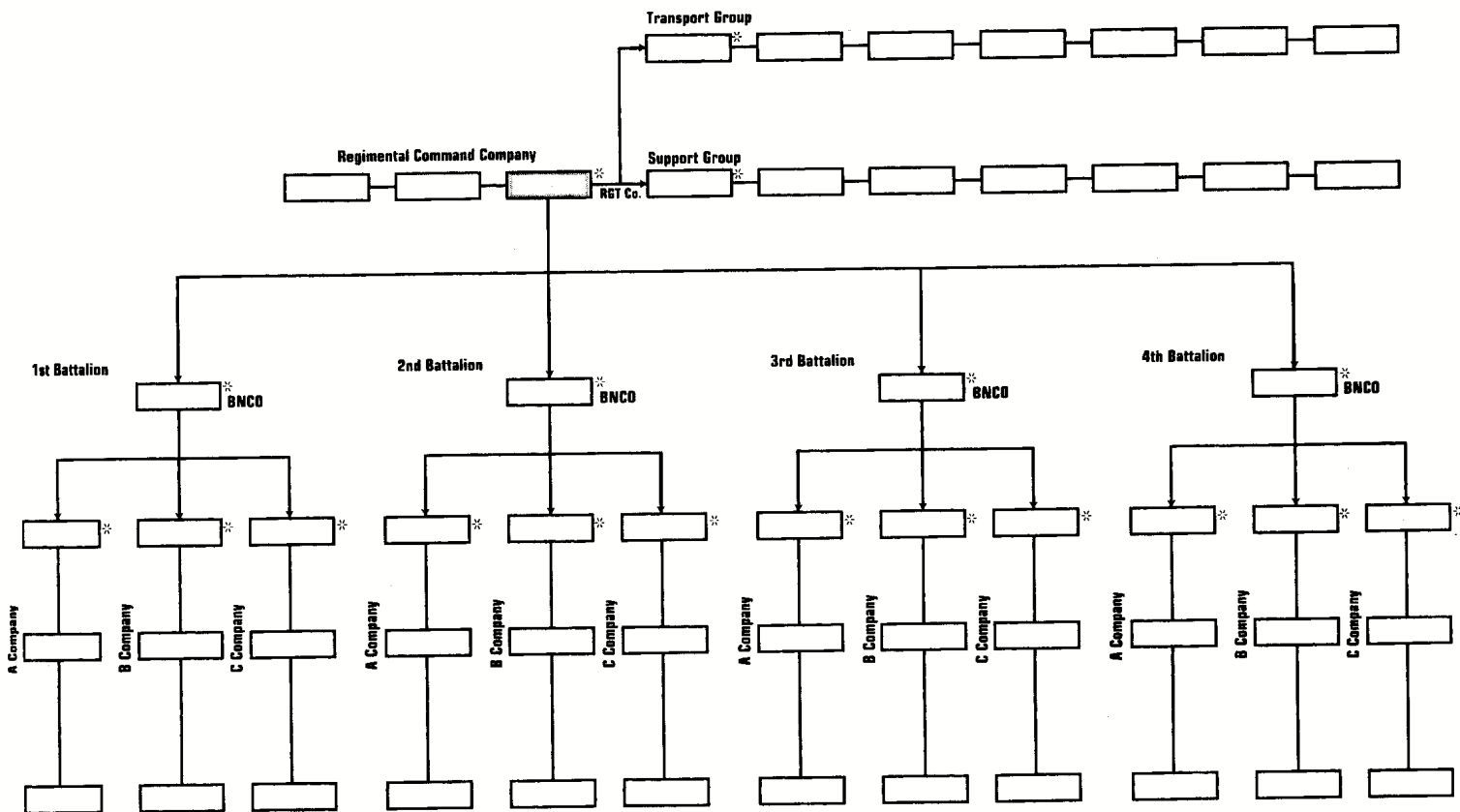

WarShip that dwarfs the *McKenna*, though the rumor has yet to be confirmed.

Employed almost exclusively as protection for JumpShip fleets, a large WarShip rarely uses its massive destructive firepower against ground targets. Because of their sheer size and firepower, most large WarShips need only fear another large WarShip.

## Space Stations

Numerous orbital facilities, colloquially known as space stations, serve a myriad of functions throughout the Inner Sphere. From factories to habitats, shipyards to system-defense stations, all of these facilities fall into one of three broad groups: low-orbit, geosynchronous-orbit or stable-point stations.

## MILITARY ORGANIZATION

**BattleForce** and **Planetary Assault** both involve commanding multiple large formations in the field. The following paragraphs describe the basic types of formations used by Inner Sphere and Clan forces.

### INNER SPHERE MILITARIES

Most militaries of the Great Houses organize their forces along the well-known Star League model described below. Irregular Inner Sphere forces, such as mercenaries and Periphery militaries, often organize by other methods that maximize their limited troop strengths. Militaries with limited resources tend to bolster their main forces with vehicles and/or infantry.

### Squad

The squad is the smallest infantry organizational group. The standard squad consists of seven men under the command of a sergeant.

### Platoon (Plt.)

The standard platoon consists of four squads (twenty-eight men) under the command of a lieutenant. The standard jump platoon (infantry equipped with jump packs) consists of three squads (twenty-one men).

### Lance

The lance is the smallest organizational unit commonly used for BattleMechs and vehicles. The standard lance consists of four BattleMechs or vehicles under the command of a lieutenant. The standard aerospace lance consists of two aerospace fighters and associated technical personnel.

### Company (Co.)

The standard company consists of three lances (twelve BattleMechs or vehicles) under the command of a captain. Occasionally a fourth lance of aerospace fighters will be assigned to the company to reinforce the primary BattleMech units. A company comprised solely of aerospace fighters is often referred to as a squadron. A standard company comprised solely of infantry troops consists of three platoons (eighty-four men).

# BATTLEFORCE 2

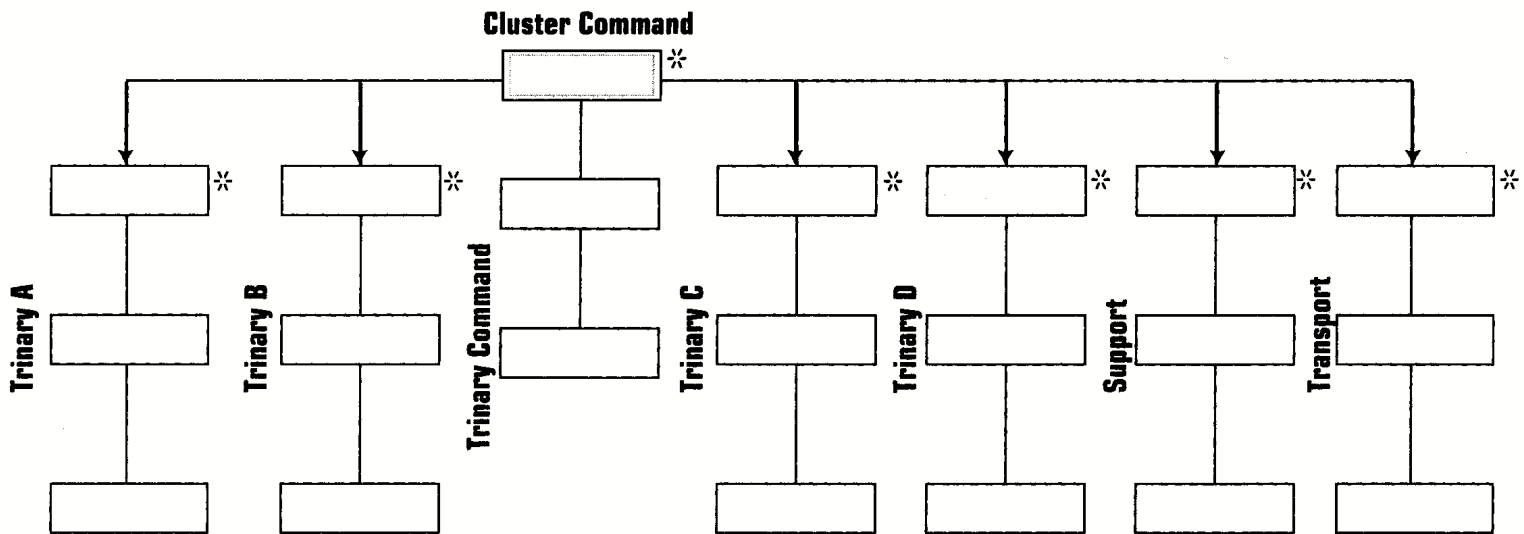

## Battalion (Bn.)

A standard battalion consists of three companies (thirty-six BattleMechs or vehicles) under the command of a colonel or major. Frequently, battalions include a command lance that provides mobile command and logistical support. In some battalions, attached aerospace lances are organized as separate companies or squadrons. A battalion that consists solely of aerospace squadrons is often referred to as a wing. A standard battalion comprised solely of infantry troops consists of three companies (252 men).

## Regiment (Rgt.)

A standard regiment consists of three to five battalions (108 to 180 BattleMechs or vehicles) under the command of a general or colonel. DropShips or JumpShips are usually attached to specific regiments, as are support battalions such as infantry or tank battalions. A standard regiment comprised solely of infantry troops consists of three battalions (756 men).

## Regimental Combat Team (RCT)

The modern regimental combat team (RCT) consists of one regiment of BattleMechs, three regiments of armored vehicles, five infantry regiments, one artillery battalion and two aerospace fighter wings under the command of a general. RCTs were introduced to modern warfare during the Succession Wars by Federated Suns military leaders. Though most of the early RCTs were ad hoc creations that often proved unwieldy in combat, RCTs are now widely incorporated into the armies of the Federated Commonwealth.

## CLAN MILITARIES

Nicholas Kerensky, founding father of the Clans, completely reorganized the old Star League Defense Force, doing away with what he called, "the tainted military organization of the past." In its place, he organized his new military along lines that emphasized small units, leaving each individual Clan to determine the exact composition of their larger formations.

## Squad

A Clan squad consists of five standard infantry troopers. Such infantry are normally deployed in the field in Points.

## Point

A Point consists of one OmniMech (BattleMech), one vehicle, two aerospace fighters, five battle-armored Elementals or twenty-five standard infantry.

## Star

A Star consists of five Points (five OmniMechs or vehicles) under the command of a Star Commander. An aerospace Star consists of ten aerospace fighters. An infantry Star consists of either five Elemental Points (twenty-five Elementals) or five infantry Points (125 men). Frequently, the Clans deploy a Star of OmniMechs and a Star of Elementals together as a single unit, known as a Nova.

## Binary/Trinary

A Binary consists of two Stars (ten OmniMechs or vehicles); a Trinary consists of three Stars (fifteen OmniMechs or vehicles). Binaries and Trinaries fall under the command of a Star Captain. An aerospace Binary/Trinary consists of two or three Stars of aerospace fighters (twenty or thirty aerospace fighters). An infantry Binary/Trinary consists of two or three Stars of Elementals or standard infantry. Two Novas deployed together are called a Supernova Binary. Three Novas deployed together are called a Supernova Trinary.

## Cluster

A Cluster consists of three to five Binaries, Trinaries or Supernovas (thirty to seventy-five OmniMechs) under the command of a Star Colonel. The standard Clan Cluster incorporates one to three Trinaries of OmniMechs, one Trinary of Elementals and one Trinary of aerospace fighters.

# BATTLEFORCE 2

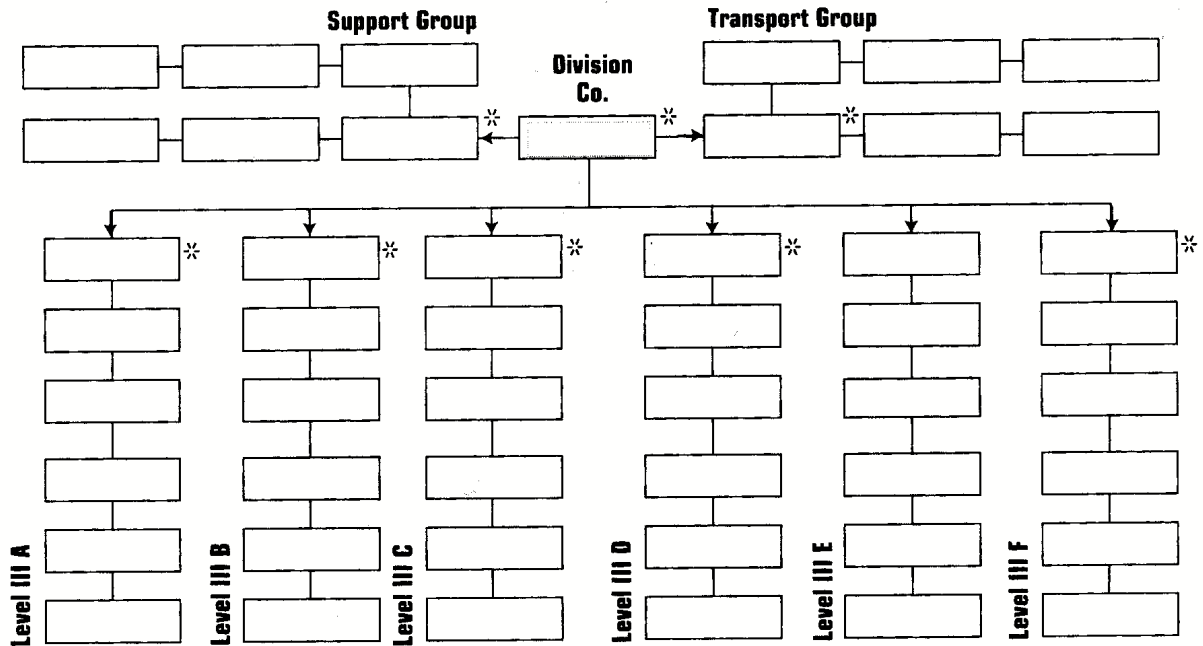

## Galaxy

A Galaxy consists of three to five Clusters (90 to 375 OmniMechs) under the command of a Galaxy Commander. Though each Clan sets its own precedent for the size and composition of its Galaxies, few Galaxies are deployed with five Supernova Clusters.

## COM GUARDS

The Com Guards organize their forces along unique lines, based on multiples of six. In addition, Com Guard Level III formations and larger are always combined-arms formations. Insisting that flexibility is the key to victory in battle, ComStar's Precentor Martial Anastasius Focht does not have a set organization for the Guards' Level III, IV and V formations. Instead, he continually fields formations that vary greatly in their composition of BattleMechs, vehicles, aerospace fighters, infantry and so on.

## Level I

A Level I unit consists of one BattleMech, vehicle or aerospace fighter, or one infantry platoon (twenty-eight men). The Com Guards do not deploy their standard infantry in any organizational group smaller than a platoon, which is commanded by a junior Adept.

Though a Level I aerospace unit technically consists of a single fighter, the Com Guards follow standard military doctrine and always deploy fighters in pairs.

## Level II

A Level II unit consists of six Level I units (six BattleMechs, vehicles or aerospace fighters) and is commanded by an Adept. A standard Level II infantry unit consists of six Level I units (168 men).

## Level III

A Level III formation consists of six Level II units and is commanded by a senior Adept or Demi-Precentor.

## Level IV (Division)

A division, or Level IV formation, consists of six Level III formations and is commanded by a senior Demi-Precentor or Precentor.

## Level V (Army)

An army, or Level V formation, consists of six Level IV formations and is commanded by a Precentor. Though ComStar still fields twelve armies, none of them consist of the standard six divisions, as the Com Guards have yet to recover completely from their staggering losses on Tukayyid against the Clans.

## STANDARD FORMATIONS

Though there are many variations on standard military formations in the thirty-first century, we will use the Inner Sphere standard designations for simplicity's sake throughout these rules.

The Formation Equivalency Table shows how the main types of formations compare. Use this table when the rules call for certain restrictions based on standard Inner Sphere units or formations. For example, a rule may state that a player may only have one HQ vehicle per battalion. In a Com Guards force, the player would be allowed one HQ per Level III formation; for Clan forces, this restriction would apply to each Cluster.

### FORMATION EQUIVALENCY TABLE

Inner Sphere	Clan	Com Guards
Lance	Star	Level II
Company	Binary/Trinary	Level III
Battalion	Cluster	Level III
Regiment	Galaxy	Level IV

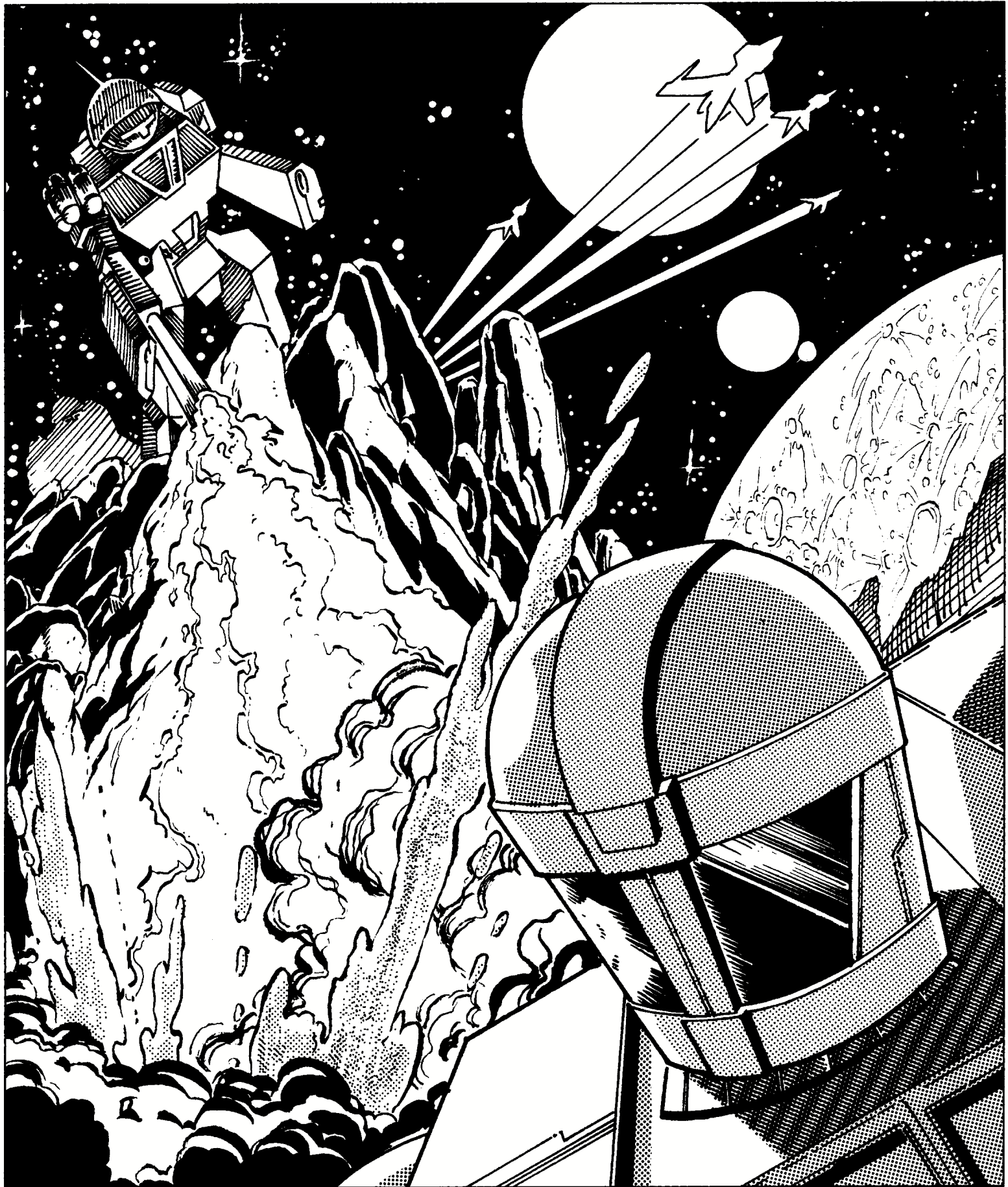

# BATTLEFORCE 2

## BATTLEFORCE

**BattleForce** is the game of mass combat in the **BattleTech** universe. Entire regiments of 'Mechs, armored vehicles and infantry clash on the field of battle, yet each individual 'Mech is represented with its own statistics in order to preserve a **BattleTech** feel in this large-scale game. Special rules allow for the easy integration of aerospace fighters, artillery and other unusual military assets into play as well, for a comprehensive simulation of all-out war that is quick and easy to play.

### COMPONENTS

The various components of **BattleForce** are described below.

### COUNTERS

Most of the counters included in the **BattleForce 2** box are used to play **BattleForce**. Each one-inch square counter represents a unit, a group of buildings, some other military asset (ECM systems, headquarters) or an objective that one side or the other may take.

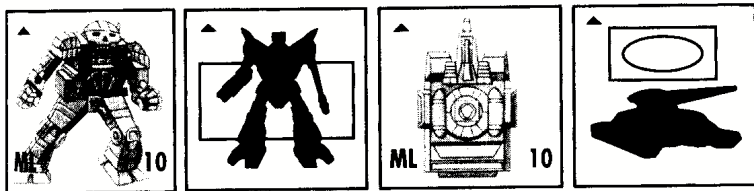

### Designations

Each counter has a designation, a one- or two-letter code in the lower left-hand corner. This designation is used during game play to identify each counter by its type (building, unit, supply convoy and so on). Designations for unit counters identify the specific unit type that the counter represents and allow players to tell it apart from other, similar units.

The first letter of the designation represents a unit's general type: 'Mech, Fighter, Ground Vehicle, Building and so on. Unit counters have a second letter that denotes the unit's specific classification within its general type (Light, Medium, Heavy and so on). Units that have no classification bear a standard code letter (see Unit Classifications, below) in order to standardize all unit counters. Counters representing buildings, objectives and headquarters have single-letter codes.

For example, the unit designation MH stands for a heavy 'Mech. The M means that the unit is a 'Mech; the H shows that it is classified as a heavy unit. Similarly, FL designates a light fighter, and GA designates an assault ground vehicle.

### Units

Units are the basic component of the game. Each unit counter represents a lance of BattleMechs or conventional vehicles, an infantry platoon or a similarly-sized aircraft or other support unit. Each individual part of a unit, such as each 'Mech in a BattleMech lance, is called an *element*. Each element in a unit makes a separate attack, and takes damage individually.

### COUNTER TYPES

Letter	Type
A	Artillery
B	Base
C	City
D	DropShip
G	Ground Vehicle
H	Headquarters
I	Infantry
J	JumpShip
M	'Mech
N	Naval Vehicle
O	Objective
S	Space Station
T	Fortress
V	VTOL Vehicle
W	WarShip

### UNIT CLASSIFICATIONS

Letter	Classification
L	Light
M	Medium
H	Heavy
A	Assault
S	Submarine
T	Transport
C	Supply Convoy
N	Normal (unarmored) Infantry
B	Battle Armored Infantry
P	Space Station (standard code)
R	Artillery (standard code)
U	JumpShip (standard code)

On the front of each unit counter is a full-color illustration of a single element of the unit's type, such as a picture of an *Atlas* to represent an assault lance. In the lower right-hand corner is a number identifying each unit among others of its type; for example, as Assault Lance 2 of the six provided. The number allows players to tell similar unit types apart during play.

The back of each counter serves as the "unidentified" side of the unit. In advanced play, the "unidentified" side is used to represent units that the enemy has not yet detected due to limited intelligence. Rather than showing the exact unit type, the back of the counter displays a general ID symbol such as "Mech Unit." For more information about unidentified units, see **Concealed Units**, p. 46.

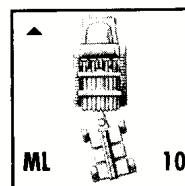

Different types of units are used depending on the forces in play. The Unit Reference Table on p. 14 lists the different unit types as well as the elements comprising them.

# BATTLEFORCE

## Command Counters

The ten counters depicting supply convoys (designation "GC") with numbered backs are used in **BattleForce** as command counters. During play, these counters enable players to simulate brilliant innovations on the battlefield that can give their forces the winning edge. For more information on using command counters, see **Commands**, p. 27.

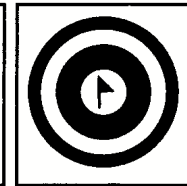
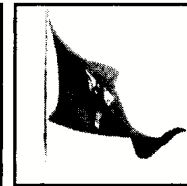
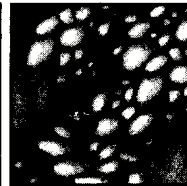
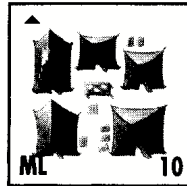
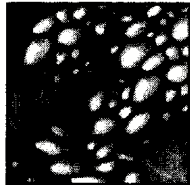

## Buildings

Base, city and fortress counters (designations B, C and T) represent small clusters of buildings. The flip side of each building counter represents a building reduced to rubble from damage. For rules on the use of buildings in **BattleForce**, see p. 43.



## ECM Counters

These counters are used to conceal the identity of ECM-equipped units when the Concealed Units rules are in effect (see p. 46).

## Objectives and Headquarters

Objective counters are used to mark certain places on the map that each player must occupy, defend or destroy in order to achieve victory. For more about objectives, see **Victory Conditions** (p. 19).

The headquarters counter can be used to mark a particular building as an HQ, though the HQ can also be considered a building in its own right. If they wish, players may also use the headquarters counter as an additional objective.

## RECORD SHEETS

The record sheet provides all the information needed to use each unit in the game, including its Movement Points (MP), armor value, weapon attack factors, weight class and any relevant special equipment. Players use record sheets to keep track of damage to the elements in their units during the game.

FASA-published **BattleForce** scenarios will provide filled-out record sheets for all units. For your own games, you will need to add the necessary information to the blank record sheet found in the back of this book.

Each record sheet can contain the information for an Inner Sphere battalion (including a command lance), a Com Guards Level III unit or a small Clan Cluster of eight Stars.

Below is a section of a typical record sheet, showing a single Inner Sphere unit, in this case, a BattleMech lance. Each part of the record sheet is described briefly below, along with important rules and terms pertaining to it.

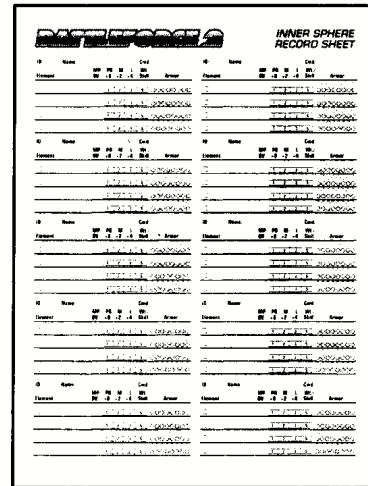

Element	MP	PB	M	L	Wt./Skill	Armor	
							OV
Zeus ZEU-6S	4	4	2	1	A/-1	○○○○○	
<input type="checkbox"/> Indirect fire			<b>1</b>	<b>2</b>	<b>3</b>	<b>4</b>	○○○○○○
Dervish DV-6M	5J	2	1	1	M/-1	○○○	
<input type="checkbox"/> Indirect fire	2		<b>1</b>	<b>2</b>	<b>3</b>	<b>4</b>	○○○○○
Flashman FLS-7K	4	4	3	—	H/0	○○○○○	
<input type="checkbox"/>	1		<b>1</b>	<b>2</b>	<b>3</b>	<b>4</b>	○○○○○○
Hunchback HBK-4G	4	4	3	—	M/0	○○○○	
<input type="checkbox"/>			<b>1</b>	<b>2</b>	<b>3</b>	<b>4</b>	○○○○

## UNIT REFERENCE TABLE

### Elements

#### Unit Type

- 'Mech
- Vehicle/Artillery
- Infantry
- Battle Armor
- Aerospace Fighter
- DropShip

#### Inner Sphere

- Lance (4 'Mechs)
- Lance (4 Vehicles)
- Company (3 Platoons)
- Platoon (4 Squads)
- Air Lance (2 Identical Fighters)
- Ship (1 Vessel)

#### Clan

- Star (5 'Mechs)
- Star (5 Vehicles)
- Star (5 Points)
- Star (5 Points)
- Point (2 Identical Fighters)
- Ship (1 Vessel)

#### Com Guards

- Level II (6 'Mechs)
- Level II (6 Vehicles)
- Level II (6 Platoons)
- Level II (6 Squads)
- (2 Identical Fighters)
- Ship (1 Vessel)

# BATTLEFORCE

## Identification

Each unit is identified by number, name and type to distinguish it from others on its side.

**ID:** MH3 is the unit's designation, which appears on its corresponding counter. MH indicates a heavy 'Mech unit, and 3 is that particular heavy 'Mech unit's number.

To determine the weight class of a 'Mech or vehicle unit, add together the Weight Values of every element in that unit (see Weight Values Table, below) and divide the total by the number of elements in the unit. Then round the result up or down to the nearest whole number (down for .5). The result is the overall unit type. For example, the heavy 'Mech unit depicted in the record sheet above consists of an assault, two medium and a heavy 'Mech. The corresponding Weight Values are 4, 3, 2, and 2.  $4 + 3 + 2 + 2 = 11 \div 4 = 2.75$ , rounded up to 3, or Heavy.

The weight class for a unit does not change during game play, even if particular elements of the unit are eliminated.

## WEIGHT VALUES TABLE

Element	Weight Value
Light	1
Medium	2
Heavy	3
Assault	4

**Name:** Smith's Lance is the name of the unit. The asterisk (\*) indicates that it is a command unit.

**Cmd:** Command unit record sheets must list any units subordinate to that command unit. The unit depicted in the example has two units subordinate to it: ML4 and MM1. (For more information on using the chain of command in game play, see **Chain of Command**, p. 27.)

## Element

**Zeus ZEU-6S** is the name of the first element of the unit.

Note that 'Mechs often come in several different models, which will have the same name but a different code number. The *Zeus* in the example is the ZEU-6S model. The ZEU-6T and ZEU-9S models of the *Zeus* BattleMech have different capabilities.

## Movement Points (MP)

The first number to the right of the element's name is that element's Movement Points (MP). If the element can jump, the MP will be followed by a "J". Vehicles can move using other modes aside from jumping; for information on these modes of movement, see p. 20.

A unit's MP always equals the lowest MP of any of its elements. The unit is considered jump-capable (J) only if all surviving elements in the unit have the Jump ability. Players must recalculate a unit's MP during play when heat or critical damage slows down an element, or when an element is destroyed.

(The record sheet also shows OV, or Overheat Value, in the second row of the same column. See **Overheating**, p. 25, for an explanation of this number.)

## Damage Values (PB, M, L)

The three numbers to the right of the MP represent the element's Damage Values, or how much damage an attack will inflict on the enemy element or unit. These are based on the range at which each one comes into play: pointblank (PB), medium range (M) and long range (L). The numbers +0, +2 and +4 at the top of the record sheet are range modifiers, which are added to the target number for making each type of attack. A pointblank attack does not modify the target number; a medium-range attack adds 2 and a long-range attack adds 4.

Pointblank attacks can only be made against units occupying the same hex as the attacker. These attacks are made with all available weapons, including short-range weapons such as machine guns and flamers, and brutal physical attacks such as punches and kicks. Some weapons, such as long-range missiles (LRMs), are less accurate at short ranges. These weapons do less damage at pointblank range, and so some elements actually have lower pointblank Damage Values than at other ranges.

Players should note that successful pointblank attacks are relatively easy to make and usually inflict a great deal of damage. However, a pointblank attack opens up the attacker to a similar, retaliatory assault by his target. Therefore, only the bravest MechWarriors or most indestructible units should make pointblank attacks.

Medium-range attacks can be made with most ranged weapons, from medium lasers to autocannons and short-range missiles (SRMs). Players can make medium-range attacks against targets up to 4 hexes away from the attacker, and these attacks usually inflict more damage than long-range attacks.

Long-range attacks can be made only by weapons with the longest scope available, including particle projection cannons (PPCs), LRMs and the powerful magnetic accelerator weapons known as Gauss rifles. Players can make long-range attacks against targets from 5 to 8 hexes away from the attacker. Though difficult to make successfully compared with other modes of attack, long-range attacks offer the greatest degree of safety for the attacker, because many targets will not have long-range attack capability and so will be unable to strike back.

## Weight Class (Wt.)

The letter immediately to the right of the damage values corresponds to the element's weight class—in the case of the *Zeus*, A for assault. This letter only applies to 'Mech, vehicle and naval units.

## Skill Modifier

The element's skill modifier, if any, appears to the right of the weight class (-1 for the *Zeus*). Skill modifiers are determined by the scenario being played. As is true in **BattleTech**, the more skilled the MechWarrior (or vehicle crew, infantry platoon and so on), the lower the skill modifier. (For example, the *best* skill modifier of a unit would be the lowest number; the *worst* skill modifier for a unit would be the highest number.) The modifier is added to or subtracted from target numbers for attacks made by the element, and so a negative value provides



# BATTLEFORCE

## SKILL MODIFIERS TABLE

BattleTech Experience Level Modifier	BattleForce Skill Level
Green	+1
Regular	+0
Veteran	-1
Elite	-2

a greater advantage than a positive one. Though skill modifiers can be any number, in general they do not run higher than +2 or lower than -4.

The Skill Modifiers Table lists typical **BattleTech** experience levels and their equivalent **BattleForce** skill modifiers. Clan elements have different skill modifiers than their Inner Sphere counterparts only when Clan honor rules are in effect (see **Clan Honor**, p. 44).

### Armor and Structure

The circles to the far right of the top row are armor boxes, which represent the armor plating that protects the element from damage. Players mark off armor boxes as the element takes damage. Below the armor boxes are shaded structure boxes (bottom row), which represent the element's critical internal components as well as its metal skeleton and myomer musculature. Damage to the structure often causes critical damage as well (see **Critical Hits**, p. 26). Players mark off structure boxes as the element takes damage, but only after all the armor is gone. For example, the *Zeus* has 5 armor boxes and 6 structure boxes.

Directly beneath the element's name, at the beginning of the bottom row, is the element's Destroyed box. Players mark off this box when an element is destroyed, to help keep track of which elements in each unit are still functional.

### Special Abilities

To the right of the Destroyed box are various abbreviated descriptions of special abilities that an element may possess. In the case of the *Zeus*, *if* indicates that this 'Mech can make indirect fire attacks. Other special abilities or equipment that may appear here include target-acquisition gear (TAG), probes and electronic countermeasures (ECM). For a complete description of these and other special abilities, see pages 34-36.

### Overheat Value (OV)

Many BattleMechs have an Overheat Value, shown beneath the MP and immediately to the left of the heat scale. The *Zeus* has no Overheat Value, but the *Flashman* and the *Dervish* do. This number represents a MechWarrior's ability to push his BattleMech beyond its ordinary operating safety limits, and thereby inflict extra damage when making attacks. However, the heat build-up caused by such activity will slow the 'Mech down and cause its shots to become erratic until it has a chance to cool off.

### Heat Scale

To the right of the Overheat Value are three boxed numbers representing the 'Mech's heat scale. When a 'Mech overheats, the amount by which it does so is added to the element's

*heat level* and marked off on the heat scale. For complete rules regarding heat, see **Overheating**, p. 25.

Only BattleMechs and aerospace fighters can overheat, and so only those types of elements need heat scales. On the blank record sheets in the back of this book, every element is given a heat scale for convenience.

### MAPSHEETS

Though **BattleForce** uses the same type of mapsheets as **BattleTech**, the scale is different. In **BattleForce**, each hex represents an area 90 meters across. When the rules refer to a single mapsheet, they use the term mapsheet. When the rules refer to the entire playing area covered by all the mapsheets in use for a scenario, they use the term playing area or simply map.

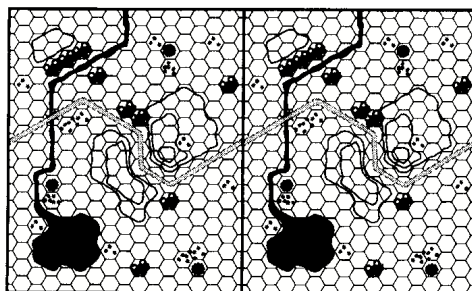

The forests, rivers, hills and rough areas on a **BattleForce** mapsheet represent a typical mixture of the terrain found on the habitable worlds of the Inner Sphere. The following symbols represent each type of terrain as described below.

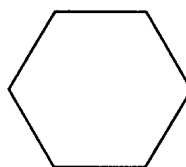

#### Clear

Clear terrain includes fields, meadows and other grasslands. The ground is firm and may be gently rolling, but its elevation does not change significantly from one side of the hex to the other.



#### Rough

Rough terrain is broken, rocky and jumbled ground. Though firm, this type of terrain is generally more difficult to cross than Clear terrain. Commonly encountered near cliffs and bluffs, Rough ground may also be formed as a result of combat.

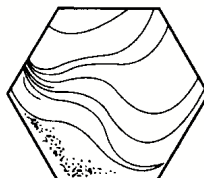

#### Hills

Hilly terrain is significantly higher than the terrain surrounding it. The lightly drawn lines in Hill hexes (called elevation lines) show slopes, which are more difficult to cross than Clear terrain because of the changes in elevation. Hills can contain

Clear, Rough, Wooded or Paved terrain, as well as buildings. Ground hexes not on a hill are at Elevation Level 0.

Elevation levels for each hill appear on the mapsheet. Level 1 is twelve meters high; a BattleMech standing behind Level 1 terrain is completely hidden. Level 2 terrain is twenty-four meters high, and so on.

# BATTLEFORCE

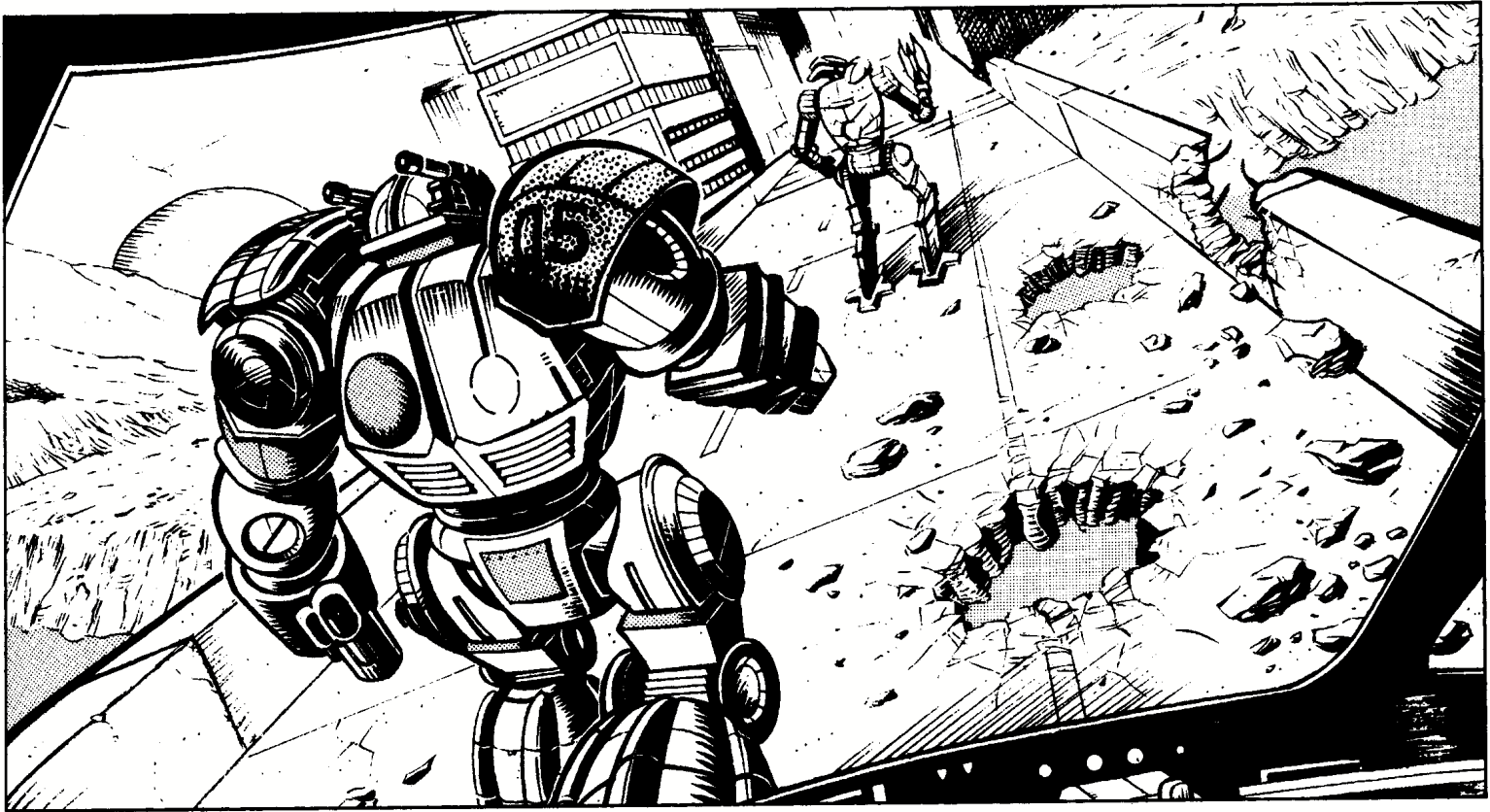

Even when an elevation line fills only part of a hex, that entire hex is considered to be at the higher elevation. Sub-levels, which are lower than the surrounding terrain, are the only exception to this rule. In the case of sub-level hexes, the lowest level present in the hex is considered the elevation of the entire hex.

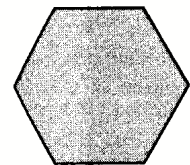

## Water

Water hexes are covered by streams, rivers, swamps, ponds or lakes. In **BattleForce**, the Depth of water marked on the mapsheet (used in **BattleTech**) does not apply. Instead, all Water hexes in **BattleForce** are approximately 6 meters

deep, enough to cover a BattleMech up to its waist. Movement through water is difficult, slowing 'Mechs down and making them easier targets. However, water helps disperse the heat generated by heavy weapons fire, and so BattleMechs whose pilots intend to fire lots of weapons sometimes occupy water despite the risks.

Even when a shallow stream fills only part of a hex, that entire hex is considered a Water hex.

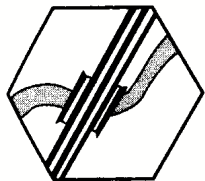

## Bridges

A Bridge hex may span a Water hex. Units moving along a road may use a bridge to go over water, which allows them to ignore the terrain restrictions and Movement penalties they would normally suffer while moving through a Water hex.

Light and medium 'Mechs and vehicles, as well as all infantry,

can cross bridges. Heavy and assault 'Mechs and vehicles will cause a bridge to collapse. A vehicle falling into water because of a bridge collapse is destroyed.

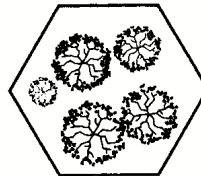

## Light Woods

Light Woods terrain is covered with sparse trees up to twelve meters in height. BattleMechs cannot cross such terrain as easily as Clear terrain, and line-of-sight through it is blocked.

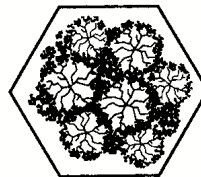

## Heavy Woods

Heavily wooded terrain is thickly covered with twelve-meter-tall trees, making movement through such areas very difficult. Light Woods often border Heavy Woods. Units cannot see through Heavy Woods.

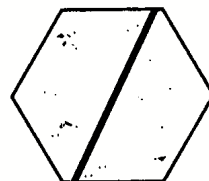

## Pavement

A Paved hex offers a fairly smooth, very hard surface. Paved hexes typically include roads, sidewalks and landing fields made of asphalt, cement or even cobblestone. Units that travel along Paved hexes containing roads ignore the slowing effects

of other terrain indicated in the hex. Paved terrain may increase the speed of ground vehicles.

## PLAYING THE GAME

This section provides game set-up rules and sequence of play for **BattleForce**, as well as a brief description of **BattleForce** scenarios and how they work.

These rules assume that there are two sides in each game, either two players or two teams of players. Wherever the rules refer to a "player," that term can mean a team of players as well as an individual.

### SETTING UP

To begin a game, the players lay out the mapsheets on a table or on the floor, in a way acceptable to all players or, if using a FASA scenario pack, according to the **Game Setup** of the scenario to be played (see **Scenarios**, p. 19, for a sample set-up). Laying out the mapsheets may also include placing a number of buildings of varying types on them. The entire play area, consisting of one or more mapsheets, is referred to as the map.

Next, the players fill out record sheets for each of their units involved in the battle. The **BattleMech**, vehicle and infantry statistics required to fill out unit record sheets appear at the back of this book (see p. 58). If all players agree, new elements for the units may be created using the **BattleTech** construction rules, provided on page 99 of the **BattleTech Compendium: The Rules of Warfare (BTC: RoW)**; use the conversion rules on p. 100 of this book to convert them to **BattleForce**.

Finally, each player places all his or her command counters in a cup or other receptacle from which they can be drawn in each turn.

### SEQUENCE OF PLAY

**BattleForce** is played in a series of turns. Each turn represents 30 seconds of game time. During a turn, all units on the map may move and make attacks.

A turn consists of several smaller segments, called phases. During each phase, players take one specific type of action, such as movement or combat. The players execute the phases of every turn in the order listed below. Specific actions, movement, effects of damage and so on that may occur in each phase are explained in separate sections of this book.

#### SEQUENCE OF PLAY

##### 1. Initiative Phase

##### 2. Player Phases

###### First Player Phases

- 2a. Command Phase
- 2b. Movement Phase
- 2c. Combat Phase

###### Second Player Phases

- 2d. Command Phase
- 2e. Movement Phase
- 2f. Combat Phase

##### 3. End Phase

### INITIATIVE PHASE

One player from each side rolls 2D6 and adds the results together to determine his Initiative. The player or team with the higher result can choose to be either the first or second player for this turn. In the case of a tie, re-roll.

### PLAYER PHASES

The next three phases of a turn (Command, Movement and Combat) are completed by the first player first, and then by the second player. The first player resolves all three phases before the second player begins.

#### Command Phase

In the Command Phase of the first turn of the game, the player draws one command counter. In subsequent turns, the player removes any face-up command counters he has in play and returns them to the cup, along with any special command counters placed to the side of the playing area (see **Commands**, p. 27). He then either draws one new command counter from the cup or moves one of his face-down command counters that is already in play (see **Chain of Command**, p. 27). Finally, the player may use any or all of the face-down command counters he has in play by turning them face-up.

#### Movement Phase

The player moves any or all of his units, one at a time.

#### Combat Phase

The player makes attacks with any or all of his units, one at a time. Each surviving element of each unit may make one attack; however, all the elements of a given unit must attack the same enemy unit. Damage from these attacks is resolved as each unit finishes its attacks.

### END PHASE

In the End Phase, both players execute any miscellaneous actions remaining in the turn, such as determining if any fires burning on the map spread to other hexes. The specific rules for such actions state whether or not they take place during the End Phase. For example, elements that began a turn shut-down from overheating may start up again in the End Phase, with their heat levels reduced to zero.

Repeat the sequence of phases until one player achieves victory. Often, the player with the last surviving unit left on the board wins the scenario. If the last units on each side are destroyed simultaneously, the game is a draw. The players may set victory conditions by using the general scenario rules below or those provided in the FASA scenario pack being played, or by mutual agreement before play begins.

## SCENARIOS

A scenario is the situation played out in a **BattleForce** game. The scenario rules tell you which units to use, where to place them on the map and what each side has to do in order to win.

A general outline for a scenario is presented below. Rules for creating your own scenarios appear in **Creating Scenarios**, p. 52.

# BATTLEFORCE



## SETUP

Before beginning play, both sides should agree on a total point value for their forces. In addition, because the scenario will provide a more equal fight if both sides use an equal number of units, both players should agree on a total number of units each side may use in the scenario. After determining the total forces for each side, each player chooses elements from the **BattleForce Rosters** (p. 118) to fill out those units to the agreed-upon point limit. As a rule of thumb, a typical scenario should involve ten units per side, with a total of 400 points to spend on elements for those units.

Once they have chosen their forces, both players roll 2D6. The player with the higher roll result is considered the first player during setup. The first player chooses one edge of the map to be his home edge. His forces will enter the map via that edge. The opposite edge automatically becomes the second player's home edge. (Once play begins and the players roll for Initiative, either one may be the first or the second player, depending on their Initiative Roll results and individual choice.)

## OBJECTIVES

Each player has two objective counters and one headquarters counter. These are placed on the map to establish key points that the player's opponent must capture, destroy or defend to win the game. In this scenario, the objectives represent key strategic locations to be occupied on the battlefield. The first player places one of his objective counters face-down

anywhere on the map within 5 hexes of his opponent's home edge. The second player does the same.

The first player then places his second objective counter face-down within 5 hexes of his opponent's home edge and at least 5 hexes away from his other objective counter. The second player does the same.

Finally, the first player places his headquarters counter in any hex on his own home map edge. Then the second player places his headquarters counter along his home map edge. In this scenario, the headquarters serves as one of the opponent's objectives. In effect, this gives each player three objectives: two he places himself and that one his opponent places for him.

Objectives do not move or attack, and do not count against stacking limits in a hex (see **Movement**, p. 20). In order to occupy an objective, the opposing player must move one of his ground units into the objective's hex. In the End Phase of that same turn, the objective counter is turned face-up. A player cannot occupy or claim his opponent's objectives.

If a face-up objective counter has friendly units in its hex or no units in its hex, it is flipped face-down again in the End Phase. Only if an opposing unit is alone in a hex with a face-up objective counter in the End Phase is that objective considered "claimed" and removed from the map. This does not apply to the End Phase in which the objective counter is initially turned face-up.

## DEPLOYMENT

Both players roll 2D6. The player with the higher result may choose whether to set up first or second. The player who sets up first places all his units on the map, then the player who sets up second places all his units on the map. Each unit must be placed on a hex along the player's home edge, excluding half-hexes. Units may start play with any facing desired.

## VICTORY CONDITIONS

This scenario continues until all units on one side are destroyed or one player has claimed all three of his objectives. The winner is either the surviving player or the player who claimed all three objectives.

This game also offers a point system to provide an alternate method of determining who wins and the level of victory achieved. Both players begin the scenario with no Victory Points. For every enemy element destroyed, the player adds twice its point value to his Victory Point total (including points for the pilot, if any). For each of his own elements destroyed, the player deducts the point value of the element (plus the pilot) from his total.

Players also score Victory Points by claiming objectives or their enemy's headquarters. The point value of occupying an objective is equal to the number of units with which your opponent started the game. Claiming an objective is worth five times as many points as occupying it. Headquarters are worth double the points of normal objectives.

At the end of the scenario, the player with the most points wins. If the difference between the two players' scores is greater than the number of points used to purchase forces for the winning side, the victory is Decisive. Otherwise, the victory is Marginal. If both players' scores are tied, the game is considered a Draw. For a list of pre-calculated point values for all **BattleForce** elements, see the **BattleForce Roster**, page 118.

## MOVEMENT

As in **BattleTech**, units in **BattleForce** change their position on the map by moving from one hex to another using Movement Points (MP). Each element of each unit has a base MP allowance listed on its record sheet. A unit's MP always equals the lowest MP of any of its surviving elements.

During each player's Movement Phase, the player may move any or all of his units.

## MOVEMENT COSTS

A unit must spend at least 1 MP to move 1 hex. If the hex that the unit is entering contains anything but Clear terrain, this cost usually increases, as shown in the Movement Cost Table.

A unit must possess sufficient MP to pay the cost of entering each new hex. However, a unit can move 1 hex regardless of the terrain cost under the following conditions: the unit enters only one hex that turn, it has at least 1 MP to spend (meaning that it is mobile), and it is not prohibited from entering the terrain in that hex.

Certain vehicles and infantry units may not enter certain types of terrain. These movement restrictions appear on the Movement Cost Table.

## JUMPING

A unit can use Jumping MP only if all of its surviving elements have jump capability (indicated on the record sheet by a "J" following the element's MP rating).

A jump-capable unit may move into any hex within its jump range. Jumping units may move over, but not land in, prohibited terrain. When a unit jumps, it can move 1 hex in any direction for every available Jump MP.

A jumping unit always travels the shortest possible path between the starting and ending hexes. If this path crosses an elevation higher than the unit's Jump MP plus the level of the hex in which the unit started the move, the unit cannot make the jump. If there is more than one possible path of equal length between the unit and its goal hex, the player may declare which path his unit takes.

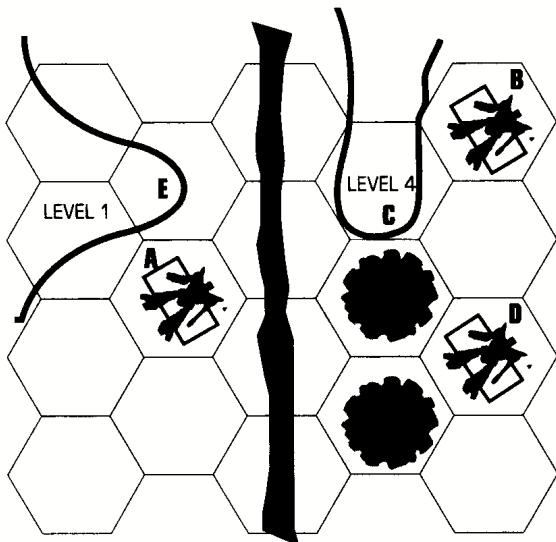

## MOVEMENT COST TABLE

Terrain Type	MP Cost Per Hex	Prohibited Units*
Clear	1	naval, submarine
Road/Paved/Bridge	1**	naval, submarine
Rough/Rubble	2	naval, submarine, wheeled
Light Woods	2	hover, naval, submarine, wheeled
Heavy Woods	3	hover, naval, submarine, tracked, wheeled
Water	3***	infantry, tracked, wheeled
Elevation Change	+1 per level	—
Base	2	naval, submarine
City	3	naval, submarine
Fortress	4	naval, submarine

\*See the **Forces** section (p. 7) for more information on the movement of elements other than 'Mechs.

\*\*If traveling along road; otherwise, use the MP cost of the underlying terrain.

\*\*\*Water costs only 1 MP per hex for hover, naval and submarine units. Infantry pay only 1 MP to enter Building hexes.

*In the diagram, the unit in Hex A has an MP of 3J. This means it can jump up to 3 hexes in any direction, over intervening terrain up to 3 levels higher than its current position. It cannot jump directly to Hex B, because the Level 4 hill in Hex C is too high for it to jump over (a unit must always jump the shortest possible distance to the landing hex, which in this case means jumping over Hex C). If the unit started its jump in Hex E, it could jump over Hex C to Hex B, because the Level 4 hill is not higher than the unit's Jump MP plus the level it occupies.*

*The unit in Hex A can jump directly to Hex D, right over the intervening river and heavy woods. By using normal movement, traveling to Hex D would cost the unit 6 MP, which means that the unit would take 2 turns to reach the same hex. The unit could also jump to Hex C.*

## MOVEMENT ON ROADS/PAVEMENT

All units traveling on roads pay only 1 MP per hex regardless of the hex's underlying terrain. A unit is considered to be traveling on a road if it moves from one hex to the next on that road.

Units may move through prohibited terrain while traveling on a road, but must begin and end their movement through such terrain on the road, and remain on the road while traveling through the terrain.

In addition, ground vehicles may receive a movement bonus of 1 additional hex for moving on a road. To move an extra hex, the unit must begin its turn on a Paved hex containing a road and continue to travel along the road for the entire Movement Phase.

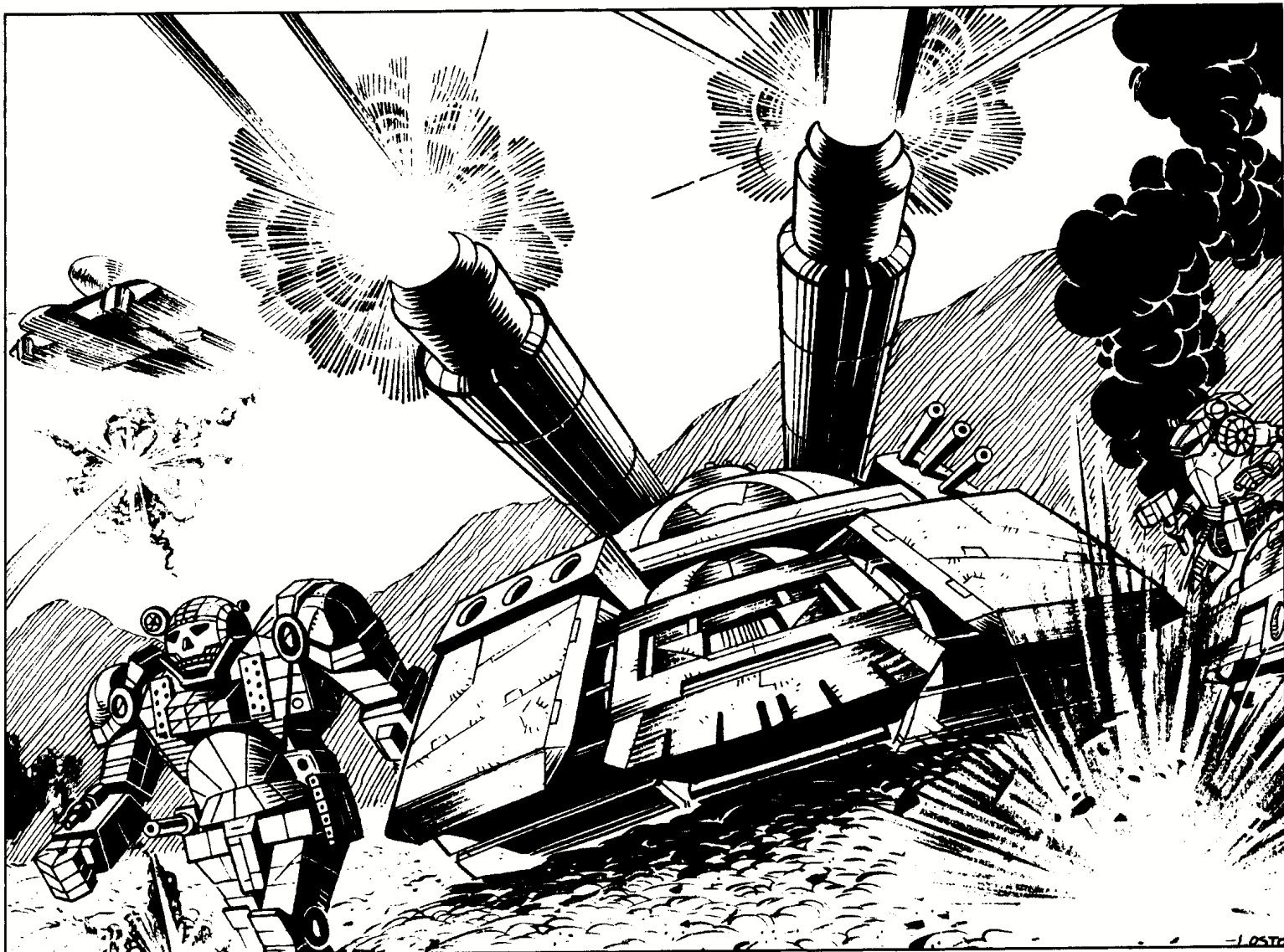

## FACING

Every hex on the map has six edges, called hexsides. In **BattleForce**, every non-infantry unit must be oriented to face one of those six hexsides. Each non-infantry unit counter has an arrow showing the direction of its facing. The facing of a unit does not represent the literal facing of every one of its elements, but rather its overall tactical deployment. The unit's facing is the direction in which most of its elements are facing during the turn, and where their attention is focused. In effect, it is the direction in which they are "looking."

A unit's facing has no effect on movement, but does affect combat (see **Combat**, p. 22). As each unit moves, the player controlling that unit can give that unit any desired facing at the end of its movement, with no MP cost.

Units not clearly facing a hexside can be realigned to one of the two nearest hexsides by the opposing player. Infantry units have no facing.

## STACKING

During the Movement Phase, a unit may move through hexes occupied by other friendly units, but may not move through a hex occupied by an enemy unit. It may *enter* enemy-occupied hexes up to that hex's stacking limit, but then movement stops. Also, a unit may not end its movement in a given hex if doing so violates the stacking limits.

At the end of a Movement Phase:

- Only one unit from each side can occupy a hex (for a total of two units in a hex).

- Infantry mounted on a vehicle and battle-armored troops riding on an OmniMech do not count against this stacking limit.

Though only one unit from a given side can occupy a hex, that unit does not actually take up the entire hex. A 90-meter-wide hex offers plenty of room for any unit to move around and avoid fire, and also allows one enemy unit to share the hex. A unit tactically controls the hex it occupies, but does not physically fill it.

See also the **Movement** section of **Aerospace Support**, p. 39 in **Special Case Rules**.

## COMBAT

During each player's Combat Phase, the player makes attacks with any or all of his units. Each unit's attacks are announced and resolved before another unit may attack.

For one unit to attack another, the attacking unit must be in the same hex as the target (pointblank range), or must have a clear line of sight (LOS) to the target. (For exceptions to this rule, see **Indirect Fire**, p. 36, and **Artillery**, p. 41.)

For an element in a unit to attack a target, the target must lie within a range for which the attacking element has a Damage Value, and within the firing arc for the attacking element's type. The attacking player then calculates the likelihood of the shot hitting the target based on the range to the target, intervening terrain and other factors.

If the attack hits the target, the target player records the result on the damaged element's record sheet.

### LINE OF SIGHT

When a player decides to fire on a unit, he must first determine whether or not his unit can see its intended target. Various terrain features can affect a unit's line of sight (LOS) to a target, making a shot difficult or even impossible.

Players can check LOS by laying a straightedge (a ruler or a sheet of paper, for example) from the center of the attacker's hex to the center of the target's hex. Any hex that the straightedge crosses lies on the LOS. If the straightedge passes directly between two hexes, the target chooses the hex through which it passes. The players then check the terrain that lies between their units for intervening features high enough to block LOS, using the following rules:

- All terrain has an elevation. If the level of a hex is not marked on the map, assume it is 0.
- If the attacking and target units occupy the same or adjacent hexes, both units always have LOS to each other.
- Any intervening elevation of a higher level than the hexes occupied by the attacker and the target blocks line of sight.
- Intervening woods block LOS through the Woods hex, but units can shoot into a Woods hex. To see if a particular patch of woods intervenes between an attacker and a target unit, use the same procedure as for elevations. A Woods hex rises 1 elevation level above the terrain it occupies.

*The following example and diagram illustrate the determination of line of sight (LOS).*

*The unit in Hex A has LOS to the units in Hexes C and D. The unit in Hex C is in Light Woods, but there are no intervening woods, so LOS exists between Hex C and Hex A. The unit in Hex D is on a Level 2 hill; this means that the woods in Hex F do not intervene, because the woods are not higher than the targeted and attacking units.*

*The unit in Hex B only has LOS to the unit in Hex D. The woods in Hex F block the line of sight to Hex C, and the unit in Hex A may choose to have the woods in Hex F block LOS because the LOS passes directly between two hexes. The Level 1 hill blocks the LOS to Hex E.*

*The unit in Hex C has a clear LOS to every unit except the unit in Hex B. The woods in Hex F are intervening, so there is no LOS between Hexes B and C.*

*The unit in Hex D has LOS to every other unit, and every other unit has LOS to it, because no intervening terrain is higher than the unit in Hex D. In order to be considered intervening, terrain must be higher than both the attacker and the target.*

*The unit in Hex E has LOS to the unit in Hex C even though Hex C is a Woods hex, because there are no intervening woods. The unit in Hex E also has LOS to the unit in Hex D. The woods in Hex C block LOS to Hex A, and the Level 1 hill blocks LOS to Hex B.*

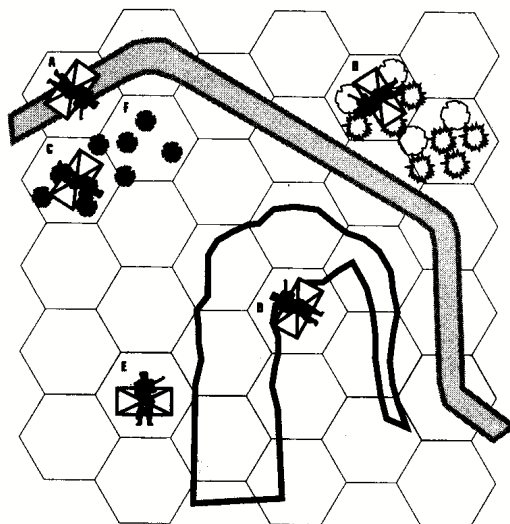

### FIRING ARCS

When the player determines that his unit can see its intended target, he must then determine if the target lies in the firing arc of the elements in the unit.

The various firing arcs are shown below. The humanoid configuration of BattleMech elements gives them a more flexible firing arc than vehicles. Infantry elements have no firing arc restrictions; they can fire in any direction.

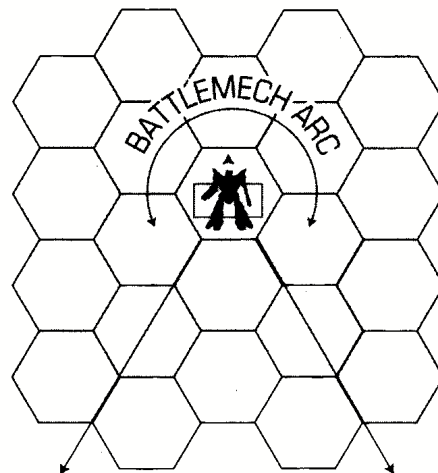

active probes.

### **Close Proximity**

If an attacking unit is close enough to its target, the attacker can get a good look at it and make better decisions about how to attack. In **BattleForce**, this means that the attacking player's opponent must reveal the current damage (if any) of

the target and the attacking unit. To determine range, begin at the hex adjacent to the attacker's hex along the line of sight, find the shortest path to the target, and count the number of hexes between those two points, including the target's hex. The number determines whether the target is at pointblank, medium or long range, and so which range modifier applies.

Each element of a unit has its own Damage Values for pointblank, medium- and long-range attacks. The sample record sheet on page 14 shows these values for a typical lance



# BATTLEFORCE

and the four elements it includes. If an element has no Damage Value at a given range, it cannot attack a target at that range. Weapons cannot hit a target at distances greater than long range (but see **Artillery**, p. 41).

Pointblank attacks are made against targets in the same hex as the attacker. A shot at pointblank range requires no range modifier (+0). Medium-range attacks can strike targets 1 to 4 hexes away from the attacker. A medium-range shot has a +2 range modifier. A long-range attack can hit targets 5 to 8 hexes away from the attacker, and has a +4 range modifier.

## Terrain Modifiers

Terrain can affect the chances of a successful shot by forcing the attacker to account for intervening land features. Units can shoot into Light and Heavy Woods hexes, but making successful shots into such terrain is more difficult than making successful shots in Clear terrain. A BattleMech in water is easier to hit. Specific terrain modifiers appear on the Attack Modifier Table.

Light and Heavy Woods hexes block line of sight through those hexes, but a target occupying a Light or Heavy Woods hex can be attacked. Modify the to-hit number by +1 against a target in Light Woods, and by +2 against a target in Heavy Woods. Building hexes also make shots into those hexes more difficult; for more information, see **Buildings**, p. 43.

Units in Water hexes find movement difficult, which limits their ability to avoid incoming attacks and launch effective attacks of their own. Add a +1 terrain modifier to the to-hit number if the attacker is in a Water hex. Modify the to-hit number by -1 if the target occupies a Water hex.

## Heat and Damage Modifiers

The attacking BattleMech may also need to modify its base to-hit number for current combat damage and heat build-up. Modifiers for these conditions are discussed in **Critical Hits**, p. 26, and **Overheating**, p. 25.

*The diagram shows an example of how to determine the to-hit number required for attacks. For this example, assume that all elements being targeted have 4 MP. The unit in Hex B is the only one with jumping movement.*

*The unit in Hex A is a Regular unit (Skill Modifier 0) and is standing in a Water hex. The modified to-hit number for an attack against the unit in Hex B would be 9 (Base To-Hit Number 5, +2 for medium range, +1 because the attacker is in water, +1 because the target has Jump capability). The modified to-hit number for an attack against the unit in Hex C would be 12 (Base To-Hit Number 5, +4 for long range, +2 because the target is in heavy woods, +1 because the attacker is in water).*

*The unit in Hex B is a Veteran unit (Skill Modifier -1). The modified to-hit number for an attack against the unit in Hex A would be 5 (Base To-Hit Number 5, +2 for medium range, -1 for the attacker's Skill, -1 because the target is in water). The unit in Hex B cannot attack the unit in Hex C, because the unit in Hex C is behind it and therefore outside its firing arc.*

## ATTACK MODIFIER TABLE

Target's MP	Base To-Hit Number
0-2	4
3-4	5
5-6	6
7-9	7
10+	8
Range	Modifier
Pointblank	+0
Medium	+2
Long	+4
Target	Modifier
can Jump	+1
is battle armor	+1
is in Light Woods or City	+1
is in Heavy Woods or Fortress	+2
is in Water	-1
Attacker	Modifier
is in Water	+1
has exceptional Skill	+ (Skill Modifier)
has Overheated	+ (Heat Level)
is using Indirect Fire	+1
Has critical damage	see p. 26

*The unit in Hex B is a Regular unit and is standing in Heavy Woods. The modified to-hit number for an attack against the unit in Hex A is 8 (Base To-Hit Number 5, +4 for long range, -1 because the target is in water. The woods in the attacker's hex have no effect on the to-hit number). The modified to-hit number for an attack against the unit in Hex B is also 8 (Base To-Hit Number 5, +2 for medium range, +1 because the target has Jump capability).*

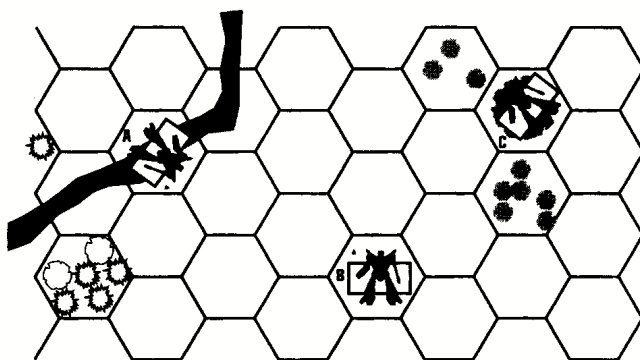

## TO-HIT ROLL

For each attack, the player makes a 2D6 to-hit roll. If the result is equal to or greater than the modified to-hit number, the attack succeeds.

If the modified to-hit number is greater than 12, the shot is still considered a hit on a roll of 12. If the modified to-hit number is 2 or less, the attack misses on a roll of 2.

## DAMAGE

Each attack that hits the target does damage to it. Damage inflicted by a successful attack is shown on the target unit's record sheet. The damage varies depending on the range to the target. For example, a successful pointblank attack by a *Hermes II* inflicts 2 points of damage, while an attack by the same 'Mech at medium range only inflicts 1 point of damage.

If an element's record sheet shows a dash (—) at a particular range, that element cannot make an attack at that range. For example, the FLS-7K *Flashman* shown on the sample record sheet (p. 14) cannot make attacks at long range; the CGR-1A1 *Charger* can only make pointblank attacks.

An attacking player may choose to inflict less than the maximum damage allowed at a given range—in most cases, as a way of concealing the attacking element's true nature from his opponent.

## OVERHEATING

Many BattleMechs have an Overheat Value, shown beneath the MP on the record sheet. This number reflects the fact that these 'Mechs have more weapons than they can fire without building up dangerous amounts of heat. A MechWarrior piloting such a machine can push his BattleMech beyond its ordinary safety limits and thereby inflict extra damage when attacking. However, the heat build-up caused by such high-power activity slows the 'Mech down and causes its shots to become erratic until it has a chance to cool off.

Only BattleMechs and aerospace fighters have an Overheat Value, and so the following rules for overheating apply only to those types of elements.

### Using Overheat Value

An attacking player must announce his intention to overheat an element in a unit at the time of that element's attack declaration.

The Overheat Value is the amount of extra damage that can be added to the 'Mech's attacks when it overheats. The controlling player can decide exactly how much to overheat, from a minimum of 1 to a maximum of the element's listed Overheat Value. This amount is added to the Damage Values for that element at all ranges for which it has them. For example, the FLS-7K *Flashman* shown on the sample record sheet has an Overheat Value of 1, and so can overheat by 1 point. This means that it can inflict 5 points of damage at pointblank range or 4 points of damage at medium range. It cannot inflict any damage at long range because it has no base Damage Value at that range.

If an attacking unit is in a Water hex, its elements can overheat with less risk because the water is doing its part to keep each element cool. The heat level of overheating elements in water goes up by 1 less than the amount of Overheat Value they use. For example, an element overheating by 1 does not increase its heat at all, while a unit overheating by 2 only increases its heat level by 1 on the heat scale.

### Using the Heat Scale

The boxed numbers and the letter "S" to the right of the Overheat Value represent the 'Mech's heat scale. When a 'Mech overheats, the amount by which it overheats is added to the element's heat level, which is then marked on the heat scale. For example, if the DV-6M *Dervish* uses its full Overheat Value of 2, its heat level rises to 2 after the current attack is

resolved. The *Dervish's* player would then mark off the "2" box on the heat scale. If the *Dervish* had raised its heat level to 1 in a previous turn and chose to overheat by 2 in the next turn without cooling down first, it would end up with a heat level of 3. The player would then mark off the "3" box.

An element's current heat level is subtracted from that element's MP and added to its attack target numbers. Mark on the heat scale in pencil, as the element's heat will rise and fall during game play. The heat level does not actually change until the attack is resolved, and so the attack modifier for overheating in one turn will not apply until the following turn.

The maximum heat level of 4 appears on the heat scale as an "S," which represents *shutdown*. A 'Mech or aerospace fighter that reaches this heat level shuts down and cannot move or attack. Attacks against a shutdown element are made against a Base To-Hit Number of 0, with no bonus for Jump capability. The unit containing the shutdown element also cannot move; however, the other elements' MP ratings are unaffected, and so they are no easier to hit in combat.

### Maximum Overheat

An element cannot overheat more than the heat scale will allow. For example, a *Black Hawk Prime* has an Overheat Value of 3. If it overheats once at this maximum value, its heat level rises to 3. In the next turn, it can only overheat by 1 additional level, because there is only one space left on the heat scale (shutdown). It cannot overheat by 2 or 3 until it cools down.

### Cooling Down

Each time an element overheats, its heat level increases. If the element makes an attack but chooses not to overheat, the heat level remains the same; it decreases only if the element makes no attack at all in a turn. In that case, the element's heat level drops to 0 at the end of the Attack Phase.

This rule does not apply to shutdown elements. In the End Phase, the heat level of any elements that began the turn shutdown falls to 0. At the beginning of the next turn, they start up again and can move and attack normally.

## ATTACK DIRECTION

When an attack hits a BattleMech or vehicle, it hits from either the front or rear. Attack direction has no effect against other types of elements.

Lay a straightedge from the center of the attacker's hex to the center of the target's hex. Compare the hexside crossed by the straightedge to the diagram below to find the side of the unit hit by weapons fire. If the straightedge crosses at the intersection of two hexsides, the defender chooses which side is hit by the attack. If the attacker is in the same hex as the target, the attack is considered to come from the front.

Attacks that strike the rear of an element inflict 1 extra point of damage.

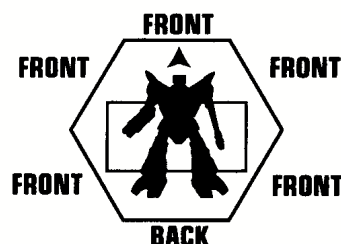

## RECORDING DAMAGE

Every time an element takes damage, the targeted unit's player finds that element's entry on the record sheets and checks off one armor box for every point of damage taken. If the target takes additional damage to a location after all the armor boxes have been checked off, the damage transfers to the element's internal structure, and the player checks off the appropriate number of structure boxes. When a hit strikes an unarmored element, check off one structure box per point of damage taken.

## Destruction

When all of the structure boxes for a given element have been checked off (armor boxes for aerospace and infantry), that element is destroyed. Any excess damage from the attack that destroyed it is lost; it does not transfer to other elements in the unit.

When all of the elements in a unit are destroyed, the entire unit is considered destroyed. Mark the unit's "Destroyed" box on the record sheet and remove its counter from the map.

A "destroyed" element need not be literally destroyed; it may simply be rendered tactically useless, in which case it is referred to as a "mission kill." Such elements are out of the game, but may be repaired later if campaign rules are being used. To determine the actual condition of damaged and destroyed elements, see **Scavenging and Repair**, p. 106.

## CRITICAL HITS

Each BattleMech and DropShip has armor and structure. Vehicles have structure only, while infantry and aerospace fighters have only armor. If an element has no armor left when it takes damage from a successful attack, that attack may inflict a critical hit. For example, a 'Mech with no armor boxes left to check off before resolving an attack may take a critical hit from that attack. If the 'Mech has one armor box left, it will not take a critical hit.

Because vehicles have no armor, any successful attack made against them may result in a critical hit. Aerospace and infantry units do not take critical hits; once they lose all their armor, they are considered destroyed.

To determine whether an element takes a critical hit, as well as the type of hit taken, roll 2D6 and consult the Critical Hits Table. Make the critical hit roll only if the element's structure alone was damaged. If the hit did armor damage, by itself or along with structure damage, do not make a critical hit roll.

Mark clearly any critical hits against an element on the record sheet. The effects of critical hits are permanent, unless you are playing a campaign game (see the **Campaigns** appendix, p. 106).



## CRITICAL HITS TABLE

2D6 Roll	BattleMech Critical Hit	Vehicle Critical Hit	Effects
2-7	No Critical Hit	No Critical Hit	—
8	Arm Actuator Hit	Turret Hit	+1 to attack target numbers
9	Leg Actuator Hit	Wheel/Track Hit	MP - 1 (minimum 0)
10	Weapon Destroyed	Weapon Destroyed	Damage Values - 1 at all ranges (minimum 0)
11	Engine Hit	Engine Hit	+1 Heat; third hit destroys element*
12	Head Blown Off	Crew Killed	Element destroyed

\*Each engine hit increases the heat build-up from firing weapons by +1. This includes standard attacks as well as attacks made while overheating. Elements that cannot overheat suffer no heat build-up, but the third engine hit still destroys the element.

## COMMANDS

Commands represent the ability of skilled field commanders to get better than the standard performance out of their troops. A little extra movement or firepower at the right moment often can mean the difference between victory and defeat. It is up to the player to skillfully issue commands to the right units at the right time to maximize their usefulness and potential.

Commands are represented in the game by numbered command counters that each player draws randomly from a cup or other appropriate receptacle, each player drawing from his or her own set of counters. The counters are numbered rather than given specific names so that the effects of these counters can change from scenario to scenario, as each army and situation dictates a different style of command.

## COMMAND UNITS

Any company-size or larger formation includes a command unit. This unit always includes the formation's commanding officer, and often also includes a communications specialist, senior sergeant and other key personnel. This unit coordinates the activities of the entire formation, and is vital to the formation's tactical flexibility. Loss of a command unit can deal a serious blow to any formation or army.

Players should designate one command unit for each formation of company size or larger among their forces. For example, a standard battalion should have four command units: one for each of the battalion's three companies, plus a fourth to act as the battalion's overall command unit. Mark this designation clearly on the unit's record sheet, but do not reveal the identity of your command units to your opponent.

## CHAIN OF COMMAND

In order to use command counters, players must know the chain of command in their forces. The diagrams on pp. 10–12 show the standard organization of forces in the Inner Sphere, the Clans and ComStar, as well as the chain of command through which orders pass.

## Chain of Command

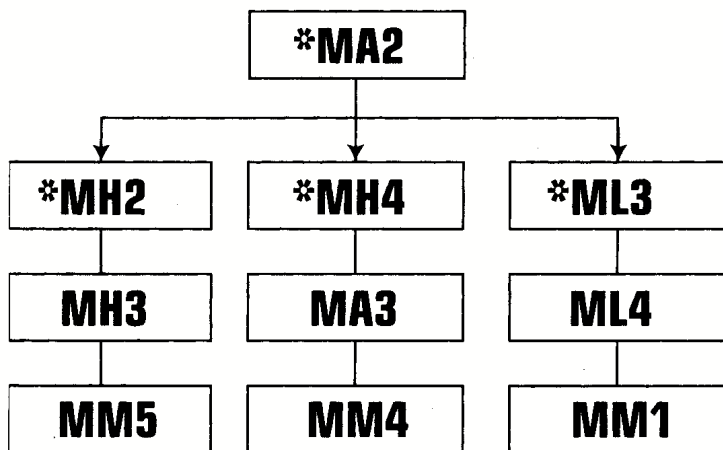

Players may use copies of these diagrams to chart the chain of command among their forces, or simply write down the units subordinate to each command unit on the record sheet. Next to each command unit's name, write the unit designation of each unit directly beneath it in the chain of command.

*The diagram shows a typical Mech battalion and its chain of command. The arrows point to subordinate units. Asterisks (\*) denote command units. The battalion command lance, unit MA2, commands the entire battalion. The units subordinate to it are the company command lances: MH2, MH4 and ML3. Unit MH2 commands A Company; units MH3 and MM5 are subordinate to unit MH2. Likewise, unit MH4 commands units MA3 and MM4, and unit ML3 commands ML4 and MM1.*

## PLACING COMMAND COUNTERS

At the beginning of each player's Command Phase, the player first returns any face-up commands that he has previously placed on his units to the cup from which they were drawn. He may then either draw a new command counter or move one face-down counter from one unit to another. A unit can have only one command counter placed on it at any one time, either face-up or face-down.

## DRAW A NEW COMMAND

If the player chooses to draw a new command, he draws one at random from his cup, looks at it and then places it face-down on any one of his command units in play that does not already have a command counter on it. If the player does not want to use the command, he can show it to his opponent and return it to the cup. A new command counter can only be placed on a command unit. If all of a player's available command counters have been placed but not yet used, he cannot draw any more until he has used some and returned them to the cup. If the player has no command units available on which to place a new command, he may not draw a new command.

## MOVE A COMMAND

Instead of drawing, a player may choose to move one of the face-down command counters in play to any of the units directly subordinate to the command unit on which the counter is currently placed. Doing so indicates that the command unit has "passed the command" down the chain of command. For example, a battalion command unit can pass a command to any one of its company command units. A company command unit can pass its command to either of the lances in its company.

Command counters must be passed down the chain of command. They cannot skip a unit in the chain, nor go back up the chain of command.

## USING COMMANDS

After a command counter is drawn or moved, the player may use any or all of the command counters that are face-down on his units. To use a command, turn the counter face-up. The command that the counter represents will immediately affect the unit on which it is placed (see **Command Effects**, p. 28),

# BATTLEFORCE

## COMMAND SUMMARY TABLE

Command	MP	Attacks	Other Effects
Alpha Strike!	—	—	Add +1 to the Overheat Values of the entire unit
Ambush**	—	—	<b>Hidden:</b> Reveal after opponent moves; may attack during opponent's turn*
Careful Aim	No Jump	-1	—
Charge!	—	—	One element in unit may make a Charging attack*
Death from Above	—	—	One Jumping element in unit may make a Death-from-Above attack*
Doubletime March	+1	+1	—
Evasive Action	—	No attacks	<b>Hidden:</b> Reveal after attack is declared on unit; all attacks against unit suffer a +2 To-Hit Modifier
Fall Back!	+2	+2	Affects all subordinate units; no subordinate unit may move closer to enemy units*
Hello, HQ?*	No Move	—	<b>Negative</b>
Jam Transmission**	—	—	<b>Hidden:</b> Negate effects of one enemy command*
Luck of the Fox	—	—	<b>Hidden:</b> Reveal at any time; unit may make a single re-roll or force opponent to re-roll once
Stand and Shoot	No Move	-2	—

\*See additional rules below.

\*\*Special Command: counter is set aside for a turn rather than being returned to cup immediately after use.

and stays in effect until the beginning of the player's next Command Phase, at which point the player returns it to the cup.

### COMMAND TYPES

Special rules apply to hidden commands, negative commands and special commands.

#### Hidden Commands

Hidden commands are not used during the owner's Command Phase, but can be left face-down and then used during the opponent's phases of the turn. The rules for each hidden command state when the command can be used.

#### Negative Commands

Negative commands represent random events such as equipment failure or bad weather that can have a negative impact on a player's battle plan. Negative commands cannot be discarded and must be placed face-up rather than face-down, to indicate that they go into effect immediately after being drawn. Negative commands always affect one of the drawing player's own command units rather than an opposing unit.

#### Special Commands

Some commands are particularly powerful (such as Ambush) or troublesome (such as Hello, HQ?). These special commands are not returned to the cup in the turn immediately after use, but instead are set aside for a turn. In the player's next Command Phase, he returns any special commands to the cup, along with any other face-up command counters.

### COMMAND EFFECTS

Each command counter has a specific effect on the unit on which it is played. The command affects every element in the unit unless the rules for the command state otherwise.

Some commands, such as Fall Back, affect multiple units. These commands must be played on one particular unit, even if the command affects a player's entire side. A command that affects multiple units can affect units already operating under different commands, and the effects of the various commands are cumulative. However, commands that impose a blanket prohibition on some ability to act—for example, 0 MP or No Weapon Attacks—cannot be modified by other commands; they remain in effect regardless of the effects of other commands.

The Command Summary Table lists the various commands available in basic **BattleForce**. Future **BattleTech** supplements for use with **BattleForce 2** will contain additional commands. The MP column shows each command's effect on a unit's MP. The Attacks column shows the modifier applied to the to-hit number for attacks made by the affected unit. The table also indicates whether a command is hidden, negative or special.

#### Alpha Strike!

An alpha strike occurs whenever a 'Mech fires all of its weapons repeatedly in a savage, all-out attack without regard for ammunition or heat. This command represents a unit's commander calling for the maximum possible firepower, throwing caution to the wind.

The elements of an alpha-striking unit add +1 to their Overheat Values for the turn in which the command is used. Every BattleMech element in the unit gets this bonus, even if a particular element had no Overheat Value to begin with. The additional overheating capacity is used in the same way as normal overheating capacity. However, not every element need use it or any of its Overheat Value when the Alpha Strike command is in effect. The command merely adds to a 'Mech's ability to overheat. Only BattleMechs can use this bonus; it does not apply to aerospace fighters.

# BATTLEFORCE

## Ambush

This command orders the unit to lie in wait for the enemy and then launch a surprise attack while the enemy is on the move. A player uses this hidden command during his opponent's phases, after the opponent has moved all of his units but before he begins to make attacks. Each element in the unit subject to this command may attack as soon as the command is used; these attacks are resolved immediately, after which the opponent's turn continues. The ambushing unit may not move or attack during its player's next Movement and Combat Phases.

Ambush is a special command, so it is set aside for one turn after use rather than being returned to the cup. In his following Command Phase, the player returns it to the cup.

## Careful Aim

By slowing down and taking more careful aim, and not using jump jets, a unit can increase the odds of its attacks hitting home. The unit commander can call for this kind of attack when it is imperative to hit the enemy *now*.

Apply a -1 to-hit modifier to attacks made by a unit under this command. However, none of the unit's elements can use any available Jump capability for the turn, making units that can normally jump a bit easier for the opponent to hit during the opposing player's next Attack Phase.

## Charge!

One element in a unit under this command makes a desperate charge against an enemy target, hurling itself physically against the enemy in an attempt to bring the target down quickly.

A single element in the affected unit may make a Charging attack at pointblank range. The base to-hit number for this attack is based on the target's MP or the attacker's MP, whichever is higher. All other standard modifiers apply.

For purposes of determining damage done by the charge, the attacking element's pointblank Damage Value is replaced by its MP, and the unit cannot increase its damage by overheating (see **Using Overheat Value**, p. 25). If the charge attack hits, the attacking element suffers damage equal to the target's base pointblank Damage Value, as if the target had successfully attacked.

## Death from Above

In this attack, a single 'Mech jumps into the air and comes crashing down on the head of an opposing element in an attempt to kill it in one fell swoop. This type of attack is often disastrous for both attacker and target.

A single jumping BattleMech in the affected unit may execute a Death-from-Above attack. Resolve this attack in the same way as a Charging attack, except that an additional +1 modifier applies to the target number. If the attack hits, the attacker may roll for a critical hit against the target, even if the target had intact armor before the attack. The roll has no additional effect if the attack would normally result in a critical hit, nor can the attacking unit inflict critical hits against units not normally subject to them, such as infantry.

If the affected unit contains no jump-capable BattleMech elements when the counter is used, the command has no effect. Return the counter to the cup.

## Doubletime March

With this command, the commander orders the unit to step up its pace and move into position as quickly as possible. The unit speeds up considerably, but loses some accuracy when making attacks as a result.

Doubletime march adds 1 to the MP of every element in the affected unit for the turn. This increased speed has the additional result of making the unit harder to hit, because an element's MP is used as the basis for the base to-hit number for attacks. However, the rapid movement also imposes a +1 modifier to the to-hit number for attacks made by the affected unit.

## Evasive Action

The Evasive Action command throws the unit into a series of erratic maneuvers intended to make them harder for the opponent to hit. Because the unit is concentrating on avoiding incoming attacks, however, it cannot launch attacks of its own in the Combat Phase of the following turn.

A +2 to-hit modifier applies to all attacks against the affected unit. Evasive action is a hidden command; a player may use it during his opponent's turn, after an enemy unit has declared an attack on the affected unit but before that attack is resolved. The attacking unit must still resolve its attack as declared.

## Fall Back!

Sometimes the best solution to a bad situation on the battlefield is to retreat and regroup. When the Fall Back command is given, every unit in the chain of command immediately begins to withdraw to a better position in order to resume the offensive.

The Fall Back command affects the unit on which it is played and every other unit below it in the chain of command. It does not affect other units on the same side.

Every affected unit adds +2 MP to all of its elements, increasing their speed and making them harder to hit. However, an additional +2 modifier applies to all attacks made by units falling back, to reflect the fact that the units are more interested in regrouping than in making accurate shots.

Units that are falling back may not move closer to enemy units at any point during their retreat. The opposing player should watch closely as the falling-back units move, to ensure that no player uses this command to advance against the enemy.

## Hello, HQ?

Sunspot activity, electrical failure and even plain human error can seriously disrupt the chain of command. In such instances, the desperate call of "Hello, HQ? Are you there?" can be heard over the comm system, much to a commander's dismay.

Hello, HQ? is a negative command, meaning that a player must place it face-up on one of his own command units. That unit may not move for as long as the command remains in effect; however, the command does not affect the MP of the unit's elements, and so they are no easier to hit in combat.

Hello, HQ? is also a special command, and is set aside for a turn after use.

## Jam Transmission

With the proper equipment, a clever communications specialist can jam enemy transmissions, disrupting his opponent's ability to relay commands. Com Guard Adepts are well-known for using this tactic to gain the upper hand.

# BATTLEFORCE

This command is revealed when an enemy command is activated. That command's effects are negated. If the target unit contains ECM or is adjacent to another unit on its side with ECM, Jam Transmission fails to work and the enemy command has its normal effect. In this case, the Jam Transmission command is still considered to have been used.

Jam Transmission is a special command, and is set aside for a turn after use.

## Luck of the Fox

During his successful reign as leader of the Federated Suns, Prince Hanse Davion was known as "The Fox" for his legendary cunning. In truth, more often than not his best ally was sheer luck that allowed his grandiose schemes to succeed against all odds.

The Luck of the Fox command represents a stroke of luck at just the right moment. A player can use this hidden command at any time during his own or his opponent's phases. The affected unit may re-roll dice once—for example, re-rolling a failed attack roll. Alternatively, the player may force his opponent to re-roll one dice roll that directly affected the unit operating under this command—for example, an attack directed against that unit.

## Stand and Shoot

Units are almost constantly moving as they advance across the battlefield, which reduces the accuracy of the attacks they make because pilots and drivers must continuously compensate for a moving unit's bumping and jerking around. To get the best possible shot, a unit must come to a halt and take careful aim, which this command allows them to do.

A unit commanded to stand and shoot may not move, but gains a -2 modifier to the to-hit number for its attacks. The MP ratings of the elements in the unit are not affected, and so the immobile unit does not present an easier target for the opponent.

## COMMAND LISTS

Each scenario, whether published or created by the players, should include a command list that shows what command each numbered counter represents. FASA-published **BattleForce** scenarios will include a command list for each scenario tailored to the forces and situation, and will often include new command effects as well.

The basic Inner Sphere and Clan command lists are given below. Use these whenever a unique list is unavailable, or when the players prefer to use a standard list.

### BASIC COMMAND LIST: INNER SPHERE

- 1 Alpha Strike!
- 2 Ambush
- 3 Charge!
- 4 Doubletime March
- 5 Evasive Action
- 6 Hello, HQ?
- 7 Luck of the Fox
- 8 Stand and Shoot
- 9 Careful Aim
- 10 Careful Aim

### BASIC COMMAND LIST: CLAN

- 11 Alpha Strike!
- 12 Alpha Strike!
- 13 Doubletime March
- 14 Evasive Action
- 15 Hello, HQ?
- 16 Luck of the Fox
- 17 Stand and Shoot
- 18 Stand and Shoot
- 19 Careful Aim
- 20 Careful Aim

### ADDITIONAL COMMAND LISTS

To add more variety to game play, you can use the following command lists to simulate the command styles of the specific Houses and Clans.

#### HOUSE DAVION

The officers of the Federated Suns, and later the Federated Commonwealth, have always had the finest military instruction available in the Inner Sphere, and so are renowned for their innovative and flexible tactics.

##### Davion Command List

- 1 Alpha Strike!
- 2 Death from Above
- 3 Charge!
- 4 Doubletime March
- 5 Evasive Action
- 6 Fall Back!
- 7 Luck of the Fox
- 8 Stand and Shoot
- 9 Careful Aim
- 10 Luck of the Fox

#### HOUSE KURITA

House Kurita's emphasis on the ancient Japanese teachings of bushido lends their officers a courage in battle unmatched by the commanders of other armies. They will go to extremes that other soldiers wouldn't dream of in order to achieve victory for the Draconis Combine.

##### Kurita Command List

- 1 Alpha Strike!
- 2 Alpha Strike!
- 3 Charge!
- 4 Doubletime March
- 5 Evasive Action
- 6 Hello, HQ?
- 7 Stand and Shoot
- 8 Stand and Shoot
- 9 Careful Aim
- 10 Death from Above

# BATTLEFORCE

## HOUSE LIAO

The Capellan Confederation is known more for political cunning than military prowess. This devious edge shows itself on the battlefield, as the Capellan officers are more likely than others to use what some call underhanded tactics.

### Liao Command List

- 1 Evasive Action
- 2 Ambush
- 3 Death from Above
- 4 Doubletime March
- 5 Evasive Action
- 6 Hello, HQ?
- 7 Luck of the Fox
- 8 Fall Back!
- 9 Careful Aim
- 10 Ambush

## HOUSE MARIK

Real military advancement in the Free Worlds League has long been bogged down by that realm's chaotic politics. In recent years, however, the leadership of Thomas Marik has rejuvenated the Marik military, especially since Thomas began using neo-chivalric codes of conduct as a beacon for officers to follow.

### Marik Command List

- 1 Alpha Strike!
- 2 Stand and Shoot
- 3 Charge!
- 4 Doubletime March
- 5 Evasive Action
- 6 Hello, HQ?
- 7 Alpha Strike!
- 8 Stand and Shoot
- 9 Careful Aim
- 10 Careful Aim

## HOUSE STEINER

Never known for its brilliant commanders, the Lyran military has nevertheless managed to earn victories through sheer determination and by having more than its share of assault 'Mechs.

### Steiner Command List

- 1 Alpha Strike!
- 2 Alpha Strike!
- 3 Charge!
- 4 Doubletime March
- 5 Stand and Shoot
- 6 Hello, HQ?
- 7 Careful Aim
- 8 Stand and Shoot
- 9 Careful Aim
- 10 Hello, HQ?

## COMSTAR

Aside from the massive battle on Tukayyid, the Com Guards have had little in the way of real battlefield experience. Com Guard officers make up for this lack of experience with some of the finest training available, along with a technological edge that almost rivals that of the Clans.

### ComStar Command List

- 1 Careful Aim
- 2 Ambush
- 3 Doubletime March
- 4 Stand and Shoot
- 5 Careful Aim
- 6 Alpha Strike!
- 7 Jam Transmission
- 8 Ambush
- 9 Charge!
- 10 Evasive Action

## CLAN GHOST BEAR

Among the invading Clans, the Ghost Bears use the most conservative combat tactics. However, few opponents can turn aside their slow and steady advances.

### Ghost Bear Command List

- 11 Alpha Strike!
- 12 Alpha Strike!
- 13 Charge!
- 14 Careful Aim
- 15 Hello, HQ?
- 16 Luck of the Fox
- 17 Stand and Shoot
- 18 Stand and Shoot
- 19 Careful Aim
- 20 Careful Aim

## CLAN JADE FALCON

The young officers of Clan Jade Falcon are eager to prove themselves in battle after suffering repeated defeats in recent years. Their recklessness has earned them an equal share of victories, but often leaves an excessive number of dead Clan warriors in its wake.

### Jade Falcon Command List

- 11 Alpha Strike!
- 12 Alpha Strike!
- 13 Doubletime March
- 14 Evasive Action
- 15 Hello, HQ?
- 16 Luck of the Fox
- 17 Alpha Strike!
- 18 Doubletime March
- 19 Careful Aim
- 20 Careful Aim



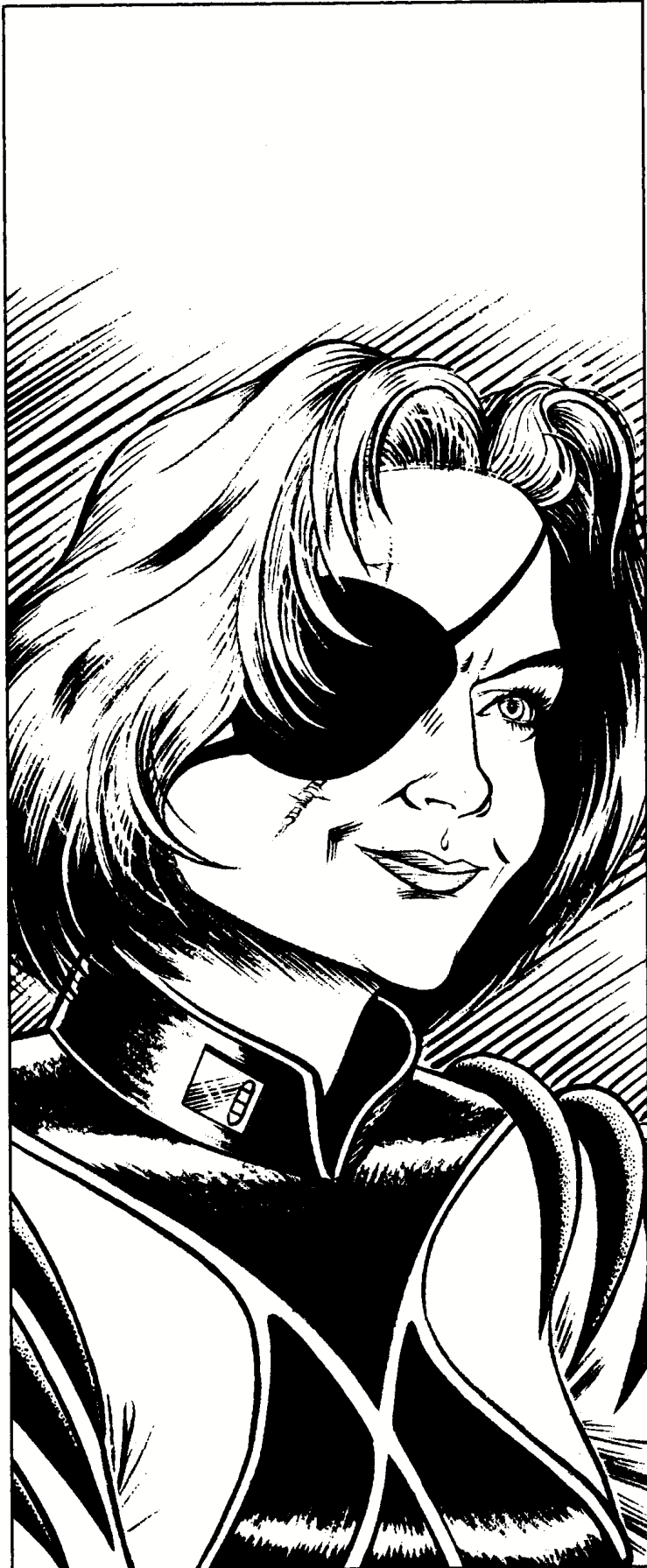

## **CLAN SMOKE JAGUAR**

The brave warriors of Clan Smoke Jaguar will stop at nothing to achieve victory, and sometimes go too far in doing so. This has earned them the enmity of their fellow Clans as well as the Inner Sphere.

### **Smoke Jaguar Command List**

- 11 Alpha Strike!
- 12 Alpha Strike!
- 13 Doubletime March
- 14 Evasive Action
- 15 Hello, HQ?
- 16 Ambush
- 17 Stand and Shoot
- 18 Stand and Shoot
- 19 Careful Aim
- 20 Death from Above

## **CLAN WOLF**

The first Clan encountered by the Inner Sphere, the Wolves are by far the most flexible. They are always prepared to accept new ideas that will help them achieve more victories and greater honor.

### **Wolf Command List**

- 11 Luck of the Fox
- 12 Alpha Strike!
- 13 Doubletime March
- 14 Evasive Action
- 15 Hello, HQ?
- 16 Luck of the Fox
- 17 Stand and Shoot
- 18 Ambush
- 19 Careful Aim
- 20 Careful Aim

## **DESIGNING COMMAND LISTS**

In their own games, players can customize their own command lists. A command list can include any ten command effects, numbered from one to ten for player one (who uses the Inner Sphere counters) and eleven to twenty for player two (who uses the Clan counters). Each command list may include the same command no more than three times, and must include at least one negative command.

## SPECIAL UNITS AND EQUIPMENT

**BattleForce** uses a wide variety of forces, each with different capabilities. The basic type of unit used in the game, the BattleMech unit, follows standard rules. Vehicles and infantry require special rules that take into account their unique abilities. This section provides those rules, as well as rules for special equipment and abilities that apply in the basic game. Rules for aerospace fighters appear in **Special Case Rules**, beginning on p. 36.

### VEHICLES

Conventional vehicle units operate in a similar manner to BattleMech units, with a few exceptions.

#### DAMAGE

Because vehicles are more vulnerable to critical damage than BattleMechs, they have no armor boxes on their record sheets. This means that every successful attack against a vehicle unit hits that vehicle's internal structure, and so may inflict a critical hit.

#### MOVEMENT TYPES

Different vehicles use special movement modes, noted on their record sheets by a letter after the vehicle's MP. The main function of each mode of movement is to restrict the vehicle from entering certain terrain types. These restrictions are summarized on the Movement Cost Table (**Movement**, p. 20).

When different kinds of vehicles are grouped together in the same unit, the most restrictive movement penalties apply to the entire unit. For this reason, vehicle units tend to be organized by movement mode.

#### Tracked (t)

Because tracked vehicles move on caterpillar treads, they are usually referred to as tanks, even though the original meaning of this term has been lost to antiquity. Commonly armed with turret-mounted heavy weapons, some of the heaviest vehicles of this class can inflict a great deal of damage, even on a BattleMech. Tanks tend to be slow, but can move over all but the most densely wooded terrain.

#### Wheeled (w)

Wheeled vehicles move faster than tracked vehicles, but still mount effective weapons. These vehicles suffer serious terrain restrictions, however, and so commanders usually assign them to relatively open terrain and cities. Most often they serve as convoy escorts or fire-support vehicles for dismounted infantry.

#### Hover (h)

Hovercraft are designed for speed, and rely on that feature rather than their weak armor and light armament for protection. Hovercraft also cost more and require a more sophisticated technological base than tracked or wheeled vehicles. Their ability to rapidly close with the enemy and just as rapidly break contact, however, makes these units valuable for reconnaissance and screening missions.

Unlike other ground vehicles, hover units can move over Water hexes at a cost of 1 MP per hex. However, they cannot enter Woods hexes.

A unit consisting entirely of hovercraft will not set off mines when it enters mined hexes (see **Minefields**, p. 49).

#### Naval (n)

Surface naval vessels come in two types: those with a displacement hull, and hydrofoils. Vessels built with a displacement hull represent the cheapest, best protected and best armed of all the naval vessels in the thirty-first-century military, but their conventional rounded hulls prevent these vessels from attaining the speed necessary to close quickly with an elusive enemy. Hydrofoils offer speed and punching power that displacement-hull vessels lack. Featuring wings that lift the vessel's hull out of the water, these naval vehicles usually patrol coastlines and guerrilla-infested river deltas.

Naval units can only occupy and move through Water hexes, at a cost of 1 MP per hex.

#### Submarine (s)

Submarine units, like naval units, can only occupy and move through Water hexes. Submarines can be surfaced or submerged. While surfaced, a submarine unit acts like an ordinary naval unit, and spends 1 MP for every Water hex it enters. A submerged submarine spends 1 MP for every Water hex it enters, and can be attacked normally by other submerged submarine units, or by other naval units or BattleMech units occupying the same hex as the submarine unit. A player controlling a submarine unit must declare it submerged or surfaced during the End Phase of each turn.

#### VTOL (v)

Fast and deadly but extremely vulnerable to damage, VTOLs and their pilots suffer the highest mortality rate of any type of combat vehicle. VTOL units can move over all terrain types, including Woods and Water, at a cost of 1 MP per hex. Because they must fly over terrain, however, VTOL units never gain a defensive terrain bonus from the hex they occupy. Physical attacks cannot be made against VTOLs.

For line-of-sight purposes, VTOL units are assumed to skim over underlying terrain at the lowest possible altitude. Treat them like other units when determining LOS, unless the VTOL unit is in a Woods hex. Because the VTOL unit must stay above the woods, it is considered one level higher than the Woods hex it occupies.

The player controlling the VTOL unit can choose to fly it higher than usual to give it a clear view of the battlefield. At the end of its movement, the controlling player announces that the VTOL unit is "flying high." Such a VTOL unit has line of sight to all units in play. However, all other units also have LOS to the VTOL.

## INFANTRY

The Inner Sphere and the Clans use distinct configurations for their infantry units. In the Inner Sphere, unarmored infantry are organized into 7-man squads. Four squads make up a platoon, except in the case of jump infantry, which assigns three squads to a platoon. The Clans use a similar arrangement, with five 5-man squads forming a 25-man Point. Five infantry Points comprise an infantry Star.

# BATTLEFORCE

The Clans organize battle-armored infantry into 5-man Points. Five of these Points combine to form a Star. In the Inner Sphere, battle armor is most often organized into 4-man squads, four of which make up a battle-armor platoon.

In the rules below, the term "infantry" refers to both unarmored and armored infantry unless specifically stated otherwise.

## INFANTRY TYPES

Infantry units come in four main types, further distinguished by the specific weapons they carry.

### Foot

Foot infantry platoons, consisting of 28 men, have no transportation other than their own feet, carry light arms and cannot hope to successfully assault or defend against even the lightest BattleMech. Foot infantry generally control restive populations, man city garrisons and mount counterinsurgency operations. Though the start-up cost for such units seems relatively high, they cost little to maintain. In another advantage of foot infantry, most planets can call up and arm thousands of such troops on short notice.

### Motorized

Equipped with a variety of light vehicles, motorized 28-man infantry platoons move around the battlefield more readily than foot infantry, but still are no match for BattleMechs. Motorized infantry units perform the same duties as foot infantry, and also frequently serve as forward observers or reconnaissance personnel.

### Jump

The 21 men in a jump infantry platoon are all equipped with jump packs. In open, flat terrain, this equipment makes jump infantry as mobile as motorized troops. In built-up areas, jump-capable troops are more mobile than any other type of infantry. Their jump capabilities allow them to close quickly with enemy units, but a close assault of this type can devastate the attacker as well as the defender.

### Battle Armor

Battle-armored infantrymen wear powered suits of armor equipped with various weapons. Though some Inner Sphere units field battle-armored troops, such equipment remains rare and is less powerful than the Clan equivalent. Clan infantrymen, known as Elementals, are organized into 5-man Points. Their individually powered suits of armor mount missiles, small lasers and anti-personnel weapons. Because Elemental armor can survive direct hits from BattleMech-class weapons, a single Point of battle armor can efficiently disable or destroy an enemy 'Mech.

When an OmniMech unit is carrying battle armor, the battle-armor unit may not make attacks, but is vulnerable to damage. Each battle-armor element is carried by the 'Mech element in a corresponding position in the 'Mech unit, counting from the top of the unit's record sheet down. The top battle armor element is carried by the top 'Mech element, the second battle armor element is carried by the second 'Mech element, and so on.

When a 'Mech carrying a battle armor element takes damage, the first point of that attack damages the battle armor element. Any remaining damage is then applied to the 'Mech element. If the 'Mech is destroyed, the battle armor is also destroyed.

## COMBAT

Infantry units have no facing. They never suffer additional damage from hits to the rear, and can attack in any direction. Because infantry elements never suffer critical hits, the damage boxes on their record sheets are all considered armor boxes.

## MOVEMENT

The biggest drawback of infantry units is their slow movement rate. However, their ability to move through most terrain types, plus the fact that other, faster units can carry them to their positions on the battlefield, lessen this disadvantage. For specific rules on loading and unloading infantry in combat, see the Transport ability (p. 36 of this section).

## SPECIAL EQUIPMENT AND ABILITIES

Certain elements have special equipment that gives them certain additional abilities on the battlefield. These abilities are indicated on the record sheet by an abbreviation underneath the name of the element, and are also listed in the far right column of the **BattleForce Roster**, pp. 118–38. The various equipment and abilities are described below.

### Active Probe (prb)

Able to detect and identify even shutdown and camouflaged units at distances much greater than standard-issue electronic warfare (EW) suites, the active probe makes a valuable addition to any recon unit.

In **BattleForce**, elements equipped with active probes can help identify enemy units and also locate hidden ones. Rules for such actions appear in **Attack Declaration** (p. 23) and **Concealed Units** (p. 46).

### Artillery (art)

Certain elements are armed with long-range artillery weapons, which are further defined by the specific type of artillery carried: L (Long Tom), S (Sniper), T (Thumper) or A (Arrow IV). In basic play, artillery elements can make indirect attacks in the same way as elements with the indirect-fire ability (see p. 36). Advanced rules for using artillery appear on p. 41 of the **Special Case Rules** section.

### C<sup>3</sup> Computer Master (c3m)

These elements are equipped with a Command/Control/Communications (C<sup>3</sup>) master computer. Usually installed in command or reconnaissance 'Mechs or vehicles, the C<sup>3</sup> computer system is designed to help unit commanders coordinate activities at the lance and company levels.

Each element equipped with a C<sup>3</sup> master can link with up to three other elements that have C<sup>3</sup> slave systems (c3s) in order to form a network. The elements in the network can make attacks using the range modifier of the element in the network closest to the target. The attacking element must still have LOS to the target, and its statistics still determine damage and other modifiers.

In **BattleForce**, members of a lance-sized network are normally in the same unit, and therefore are always at the same range to any given target. However, a network can be expanded with the addition of another C<sup>3</sup> master computer. Up to three C<sup>3</sup> master computers can be linked to a fourth C<sup>3</sup> master to create a

# BATTLEFORCE

company-sized network. This larger network can contain no more than twelve C<sup>3</sup>-equipped elements. All twelve of the linked elements can fire using the range modifier of the unit closest to the target. Elements with C<sup>3</sup> masters need not also have C<sup>3</sup> slaves in order to link up in this way.

Destruction of an element carrying a C<sup>3</sup> master shuts down the portion of the network controlled by its computer. When the C<sup>3</sup> controls a lance, destroying the C<sup>3</sup> cuts the unit's remaining lancemates out of the network. When a C<sup>3</sup> is coordinating a company network, its destruction cuts the lances in the company off from each other, but each individual lance can still use its own C<sup>3</sup> network (though in **BattleForce** play, this offers no advantage). The diagram below shows a C<sup>3</sup> network in action.

The C<sup>3</sup> master (but not the slaves) also duplicates the function of target acquisition gear (TAG). Units that are equipped with C<sup>3</sup> that are spotting targets for or launching indirect fire use the indirect fire rules (see **Indirect Fire**, p. 36).

## C<sup>3</sup> Computer Slave (c3s)

An element equipped with a C<sup>3</sup> slave can link into a C<sup>3</sup> network as described above. Elements with C<sup>3</sup> slaves but no master cannot create a network, and so confer no special ability on the element.

## Cargo (car #)

An element marked as "cargo" can be carried by a transport (see **Transport**, p. 36). The number indicates how many tons of the transport's cargo space the element takes up. The tonnage can be split between multiple transports, so long as all of the transports are in the same unit.

## Coolant Truck (cool)

This type of vehicle carries large tanks of coolant that it can use to cool down overheating 'Mechs. Coolant vehicles are also useful for putting out fires.

A player can use a coolant truck to cool down a friendly unit in an adjacent hex. A single coolant truck can cool down all the BattleMech elements in a single unit. In order to hook up to the coolant, both the coolant truck's unit and the unit being cooled down must remain immobile. Because they cannot move, both units can be attacked using a Base To-Hit Target Number of 0, rather than using their MP ratings. However, the elements in the unit being cooled down can use their Overheat Values without any increase in their heat levels.

Coolant trucks can also put out fires quickly and easily, but must get dangerously close to the fire to do so. During a turn's Combat Phase, a coolant truck can extinguish one fire in its own or one adjacent hex in lieu of making an attack.

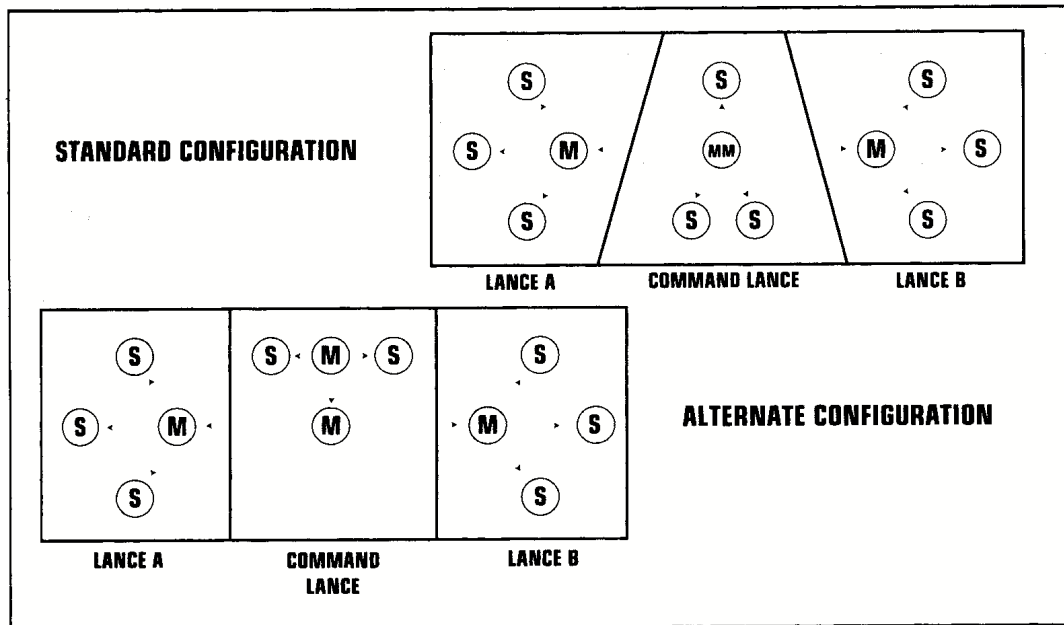

In the diagram, each circle represents an element and each box encloses a unit. Each "S" represents a C<sup>3</sup> slave. Each "M" represents a C<sup>3</sup> master. The arrows show the network links radiating out from the master elements. Destruction of slave elements has no effect on the overall network. However, destruction of a master element will eliminate all the links pointing away from it.

Company-sized networks can be arranged in the two ways shown. The first represents the most common arrangement, with a single element carrying two master computers and coordinating its own lance as well as the entire company. The second example shows a separate element in the command lance carrying the computer that links the master units together in the company network. Though in theory a single element can carry three or four master computers, the resulting increased vulnerability of the entire network makes this useless in practice.

## Electronic Countermeasures (ecm)

An ECM suite is a broad-spectrum jamming and electronic-countermeasure device designed to reduce the effectiveness of enemy long-range scanning and surveillance equipment. Such a system nullifies the effects of any enemy unit's active probes or C<sup>3</sup> computers whenever any of those systems is in the ECM suite's area of effect. Friendly active probes or C<sup>3</sup> computers are not affected, nor does the ECM suite affect other scanning and targeting devices, such as TAG. An ECM suite's area of effect is a 1-hex radius from the unit carrying it, as described below.

ECM negates the effects of systems listed above whether or not they are being used against the ECM-equipped element. An ECM suite affects enemy units if an element in the target unit, in a hex adjacent to the target unit, or in the same hex as or a hex adjacent to the attacking/probing unit is equipped with ECM, or if the LOS from the attacking/probing unit to the target passes through the ECM-equipped unit's hex or a hex adjacent to it.

An ECM suite interferes with a C<sup>3</sup> network in the following ways: if the C<sup>3</sup> master that is coordinating a company network

is in the area of effect of the ECM, the entire network stops functioning. If a subordinate unit in the network is in the area of effect of the ECM, the unit is isolated from the network, though the rest of the network still functions. If the LOS from the C<sup>3</sup> master coordinating the company to a subordinate unit passes through the ECM-equipped unit's hex or a hex adjacent to it, the subordinate unit is cut off from the network.

ECM has additional effects when using the Concealed Units rules; for more information, see **Special Case Rules**, p. 46.

## **Engineering Vehicle (eng)**

An engineering vehicle is equipped with bulldozer blades, shovels and other equipment that allow it to clear a path through rubble. A unit that contains at least one engineering vehicle does not spend the standard MP to move through a Rubble hex, but instead pays the MP cost of the underlying terrain.

Engineering vehicles can also be used to clear terrain (see **Clearing Woods**, p. 46). Engineering vehicles also excel at clearing minefields safely (see **Minefields**, p. 50).

## **Headquarters (hq)**

A headquarters element contains additional communications and control gear that increases command efficiency. Each headquarters element on a side allows that side's player to move one additional command counter per turn (see **Commands**, p. 27). Though the headquarters special ability does not allow a player to draw an additional command counter, it does allow him to both draw and move counters in the same Command Phase.

Neither side may have more than one headquarters element active per battalion. Any additional HQs present have no effect on game play. Note that the headquarters special ability is different from the headquarters counter that each side plays during the Objectives part of scenario setup. The headquarters counter does not provide the hq special ability unless the scenario rules specifically confer that ability.

## **Indirect Fire (if)**

The indirect fire ability allows an element to attack without having LOS to the target by arcing its attack over intervening obstacles in a way similar to a mortar or artillery attack. In order for a unit to attack indirectly, another friendly unit must have LOS to the target. One element of this friendly unit acts as the spotter. The spotting element may not make an attack of its own, though it must be in position and able to make an attack in order to spot. For example, a shutdown element or a unit under the effects of an Evasive Action command may not spot.

The appropriate terrain modifiers in the LOS between the spotter and the target, plus any other modifiers for both the spotting and firing units (such as skill modifiers and command counters), plus an additional +1 penalty, all apply to an indirect-fire attack. If the attack hits, it inflicts long-range damage from the firing unit, regardless of the actual range to the target.

## **MASH (mesh)**

MASH elements are equipped as Mobile Army Surgical Hospitals (MASH). Players can use them in campaign play to repair damaged infantry units between battles (see **Campaigns**, p. 106). In standard play, they have no effect.

## **Move or Fire (mof)**

This restriction currently applies primarily to artillery units. An element with this restriction may not attack in a turn in which it also moved.

## **OmniMech (omni)**

An OmniMech is modular in design, which means that it can swap weapons quickly and efficiently between battles and take on a different role. For example, a fire-support OmniMech can be converted to a close-assault 'Mech for the next mission in a matter of minutes. This ability is most useful in campaign play, as changing weapon pods takes too long to be performed feasibly during a regular game (see **Campaigns**, p. 106).

OmniMechs are also constructed so that they can transport battle-armor units. Each OmniMech has handholds on its "skin" that allow it to carry a single Point (or squad) of battle armor. In **BattleForce**, this means that each OmniMech element can carry a single battle-armor element. Treat this ability in the same way as other types of infantry transport (see **Transport**). OmniMechs may only carry battle armor in this way.

## **Spheroid DropShip (sph)**

This type of DropShip has special characteristics, such as the ability to hover and land vertically, that distinguish it from other types of DropShip units. For more information, see **Aerospace Support**, p. 39 in **Special Case Rules**.

## **Target Acquisition Gear (tag)**

Target acquisition gear (TAG) consists of a special laser that is used to designate targets for Arrow IV artillery attacks. This equipment can be used only in conjunction with the advanced artillery rules (see **Artillery**, p. 41).

## **Transport (tran #)**

A transport element can carry infantry and other cargo. The number is the number of tons of cargo the element can carry. Normally, transport elements carry infantry and other elements designated as "cargo" into battle.

A transport unit carrying infantry can load or unload them at the beginning or end of the transport's movement. Infantry must be in a hex adjacent to the transport in order to be loaded, and also must be unloaded in an adjacent hex.

A transport unit may not load and unload infantry in the same turn. The unit being transported may not move in the same turn that it is loaded or unloaded, nor may it make attacks or be attacked while being transported. However, the transported unit may make attacks normally in the same turn that it is loaded or unloaded.

If all of the transport elements in the transporting unit are destroyed, the unit being carried is also destroyed. If enough elements of a transport unit have been destroyed at the beginning of its controlling player's Movement Phase to reduce the transport's total tonnage capacity below the amount required to carry the entire transported unit, the transported unit is immediately unloaded in an adjacent hex. The transported unit takes no damage from this process (see **Battle Armor**, p. 34, for an exception to this rule).

## SPECIAL CASE RULES

This section offers detailed optional rules for resolving specific, strategically important situations that players may want to play out as part of their game. Players can use these rules to simulate the effects of artillery, minefields, fire, hidden units and other tactical advantages. This section also provides simplified rules for incorporating air assets into **BattleForce** scenarios, based on **BattleSpace** rules. The Offboard Units rules appear at the beginning of this section in order to explain certain concepts necessary for understanding how to use aerospace and artillery support in **BattleForce**.

All players should review the optional special-case rules and agree on which ones to include in their game before beginning play.

### OFF-BOARD UNITS

In larger games, not every unit will be on the mapsheet. Some units can be behind friendly lines as reinforcements, while artillery and aerospace units are most often deployed far from the battlefield. Using the following rules, units can begin play off the mapsheet or move off the mapsheet during play.

### THE SUPPORT MAP

The **BattleForce 2** set includes a special 8 1/2" x 11" map called the support map. This map is used to track the movement and location of off-board units. The support map should be placed to one side of the playing area, within easy reach of both players.

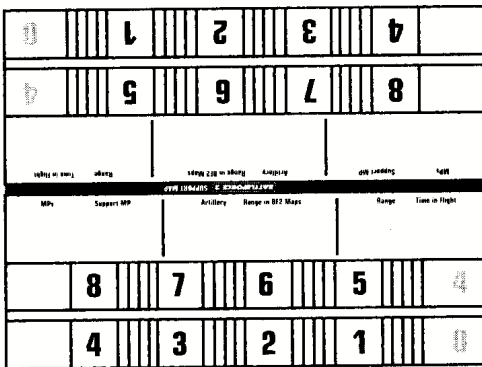

Facing each player on the support map is two rows of boxes numbered 1 to 8. Each of these boxes represents an additional **BattleForce** mapsheet that players can use to indicate the placement or location of offboard units such as artillery assets and other reinforcements. All eight boxes should be considered a single continuous row, with Box 1 representing the mapsheet lying closest to the player's home map edge and Box 8 representing the mapsheet lying farthest away. Players place their off-board units in these boxes (on a designated mapsheet) as directed by the scenario set-up rules or by mutual player consent.

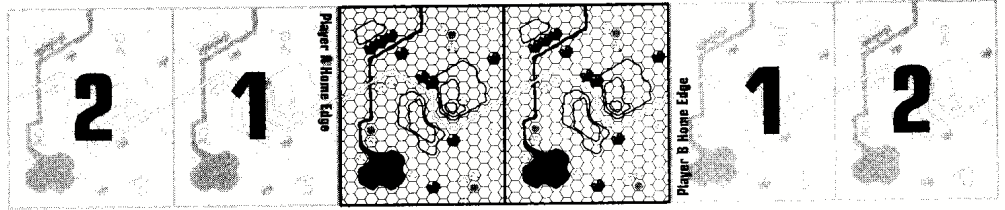

The above diagram should help you visualize what the boxes on the support map represent. The mapsheets in black printing are the actual mapsheets laid out to represent the playing area. The gray mapsheets on either side are where support map boxes 1 and 2 would be if they were part of the playing area.

### SUPPORT MOVEMENT

Units on the support map move during their controlling player's Movement Phase. They can move from box to adjacent box as described below.

A unit does not use its normal MP while moving on the support map. Instead, the MP used by each unit on the support map is based on the unit's normal MP rating as shown on the table below.

Normal MP	Support MP
1-4	1
5-8	2
9-11	3
12-15	4
16+	5

Each box on the support map represents an entire mapsheet. In the same way that it usually takes multiple turns for a unit to cross a mapsheet, it also usually takes several turns to move from box to box on the support map.

Each box is separated from the adjacent numbered boxes by four rectangular spaces. These spaces are used to track movement from one box to another. For the purpose of calculating distance moved, each box is also considered a space.

To travel from one box to the next adjacent box, a unit may move a number of spaces up to its support MP rating in either direction. To move a unit, simply move the unit's counter forward a number of spaces equal to the unit's support MP. As long as any part of a unit's counter remains in a box, it is considered to be in that box for purposes of combat. Once the counter reaches the next box, move the entire counter into that box before continuing to move the counter in that direction.

It takes a total of 5 MP to move from one box to the next.

# BATTLEFORCE

Turn 1: in box 3

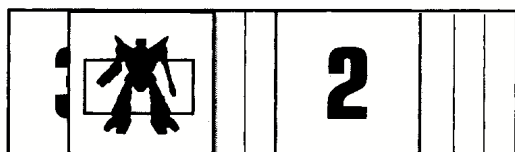

FIG. A

Turn 2: in box 3

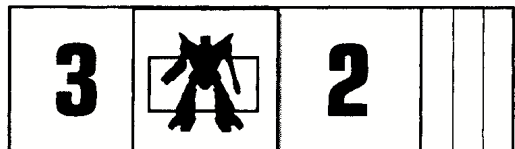

FIG. B

Turn 3: in box 2

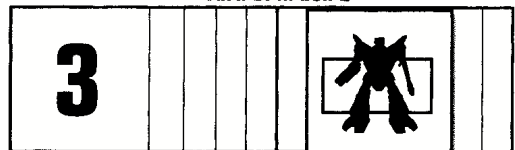

FIG. C

A heavy BattleMech unit with 5 MP starts play in Box 3 on its side of the support map. This means it is three mapsheets away from the battlefield. Checking the Support MP Table, the player notes that 5 MP means that the unit has 2 MP on the support map. The player wants the unit to immediately head for the fight in the playing area, so he moves the unit 2 spaces to the right in his first Movement Phase (see Fig. A). Because part of the unit's counter still overlaps Box 3, the unit is considered to be in that box.

In the next turn, the unit moves another 2 spaces to the right (see Fig. B). It is still considered to be in Box 3. In the third turn, the unit moves yet another 2 spaces to the right. This time, its first MP moves it into Box 2 and its second MP moves it into the first space to the right of Box 2. The unit is now considered to be in Box 2 (see Fig. C).

This process is repeated in the following turns. It will take 5 more turns (moving 2 MP per turn) for the unit to reach the battlefield. Hopefully, the player's side can last that long without reinforcements.

## Stacking

Stacking limits do not apply on the support map. Any number of units from both sides may occupy each box.

## Leaving the Support Map

Units can leave the support map one of two ways. By moving to the left from Box 8, the unit immediately leaves play. It may not re-enter, and for purposes of determining victory it is considered withdrawn from battle. By moving to the right of Box 1, a unit moves toward its home map edge. The unit does not actually reach the mapsheet until it leaves Box 1 completely and enters Box 0. Once it reaches Box 0, it emerges on the mapsheet and its movement is over for the turn. The unit is placed on the player's home map edge, in any desired hex.

## Entering the Support Map

A unit can enter its side of the support map by moving off its home map edge. By moving off the opponent's home map edge, a unit can enter the opponent's side of the support map. In both cases, the unit is placed directly on Box 0 on the appropriate side of the support map, and its movement ends. In the controlling player's next Movement Phase, the unit can begin moving toward Box 1.

## SUPPORT COMBAT

Combat can occur on the support map if enemy forces occupy the same box (except for artillery; see **Artillery**, p. 41). In each Combat Phase, players may launch attacks against enemy units in the same way as on the mapsheet, except that terrain considerations do not apply on the support map and range is always considered medium when resolving attacks.

## SETUP

When using the Off-Board Units rules, each player may place his artillery and aerospace units on his side of the support map in any desired boxes. The specific scenario rules being used may also call for a certain portion of each player's forces to be off-board as reinforcements (see **Creating Scenarios**, p. 52).

## AEROSPACE SUPPORT

The following rules allow players to use aerospace units in conjunction with ground forces, including strafing and bombing attacks made by fighters and rules for using grounded DropShips. These rules are a simplified version of the **BattleSpace** rules. Players who own **BattleSpace** can use its rules to resolve fighter-to-fighter dogfighting in space, as well as JumpShip and WarShip combat.

Unlike slower air units such as VTOLs, which are treated like ground vehicles that can fly over terrain, fast aircraft such as aerospace fighters and DropShips need special treatment in **BattleForce**. To clearly distinguish between these types of flying units, only the faster units are classified as aerospace units. Aerospace units include DropShips, aerospace fighters and conventional aircraft. Other flying craft follow the rules for ground vehicles unless otherwise specified.

Aerospace units move in terms of mapsheets rather than hexes, but are placed on the map while the game is played along with other types of units. Most of the time, aerospace units will be off-board on the support map (see **Off-Board Units**, p. 37). However, they will be placed in mapsheet hexes while attacking ground targets on the map or dogfighting in-atmosphere with other fighters. They will move through given hexes, make bombing and strafing runs, and may be targets of counterattacks.

## GAME SETUP

The number and type of fighters available to each side is normally assigned by the scenario being played, in much the same way as artillery support and minefields. Players may also purchase aerospace units with points, just as they may purchase other types of units. We recommend that both players set aside a separate, equal amount of points for aerospace forces, as opposed to drawing them from the same force lists as ground troops. This strategy ensures that both players forces will be more closely balanced against each other.

# BATTLEFORCE

**BattleForce** assumes that aerospace units begin play in the air unless otherwise specified. Aerospace units on the ground must take off using the Launching rules (p. 40) before they can move.

## Carrying Bombs

Players must assign bombs to any fighters that will carry such munitions before play begins. Each fighter element can carry a number of bombs based on its weight class: Light fighters can carry 1 bomb, medium fighters can carry up to 2 bombs, and heavy fighters can carry up to 4 bombs. Carrying 1 or more bombs slows a fighter down, reducing the element's MP to half of its full value (round down) until all of its bombs are dropped. This MP reduction makes fighters carrying bombs easier for the opposing player to hit.

For rules on using bombs, see **Bombing**, p. 41.

## MOVEMENT

The movement of aerospace units is expressed in terms of mapsheets rather than hexes. The unit's MP is the number of mapsheets or boxes on the support map that it can move per turn. A unit can move across mapsheets, support map boxes or both in a single Movement Phase.

Aerospace units on the support map move directly from one box to the next. They do not use the spaces between boxes to move, nor do they convert their MP to support MP as other units do when on the support map. Like other units, if an aerospace unit moves off the left side of support map Box 8, it leaves the playing area and may not return. Box 0 does not count for aerospace units; they move from Box 1 to the first mapsheet on the same side.

If an aerospace unit ends its move on a mapsheet, place the fighter in any desired hex on the map where its movement ended, with any desired facing. Choose the hex depending on the kind of attack the player wants his aerospace unit to make, if any (see **Attacks**, p. 40).

Normal stacking limits apply separately to aerospace units while in flight. Each hex may contain one ground unit and one aerospace unit from each side at the same time. All airborne aerospace units are assumed to be flying at a low enough altitude that they can attack ground units or be attacked by them. In the interests of simplicity, **BattleForce** does not allow for aircraft moving to various altitudes.

*An aerospace unit in Box A on the support map would need to spend 3 MP to move to Hex B on Mapsheet 2 to strafe the 'Mech unit in Hex D. The unit would move from Box 2 to Box 1, then from Box 1 to Mapsheet 1, and then from Mapsheet 1 to Mapsheet 2. The unit could end its 3 MP move in any hex on Mapsheet 2, not just Hex B.*

*An aerospace unit in Box C would need to spend 6 MP to reach Hex B. The unit would need to spend 9 MP to move from Box A directly to Box C.*

## Stalling

All aerospace units, with the exception of spheroid DropShips, must continuously move forward to keep from stalling and crashing. They also have a limited turning radius, which means they have to make a wide "U-turn" before they can attack the same point a second time.

In game terms, this means such units cannot stay on the same mapsheet or support map box two turns in a row. They must move at least one mapsheet during the Movement Phase as long as they are airborne.

Spheroid DropShips can hover, and so they need not move every turn. Record sheets for spheroid DropShips are marked "sph" under special abilities.

## Landing

An aerospace unit can land in any off-board box that does not contain enemy units. The unit lands instead of moving during the controlling player's Movement Phase, and cannot make any attacks during that turn.

On the main mapsheet, spheroid DropShips can land in any hex except Water and Heavy Woods hexes. As with landing on the support map, the DropShip lands instead of moving during the controlling player's Movement Phase, and it cannot make any attacks during that turn. If a spheroid DropShip lands in a Light Woods hex, the hex automatically becomes Rough terrain, per the **Clearing Woods** rules (p. 46).

Other aerospace units landing on the main map must land on a runway. Because the battlefield rarely offers ideal runways, these craft can also land on Clear and Paved terrain. The amount of runway space a unit needs is based on its weight class. For example, lighter craft can stop sooner and so can land on a shorter runway. The number of runway hexes needed for each class of aerospace unit to land safely is given on the Runway Table. These hexes must lie in an uninterrupted straight row and must consist of Road, Paved and/or Clear terrain, with no elevation changes. All runway hexes must also be clear of units and buildings.

When an aerospace unit lands, it lands on a runway at the end of its move. The unit ends its movement in the first hex of the runway, then moves along the ground and ultimately ends its landing in the last hex of the runway, facing in the direction in which it had been traveling.

Once landed, a spheroid DropShip cannot move until it launches. Other aerospace units can taxi along the ground at a rate of 1 MP, but can only enter Clear, Road and Paved hexes. DropShips are so large that no unit may enter or occupy the same hex as a grounded DropShip. Other aerospace units follow standard stacking rules when grounded (see p. 21).

8	7	6	5	4	3	2	1	0
8	7	6	5	4	3	2	1	0
8	7	6	5	4	3	2	1	0
8	7	6	5	4	3	2	1	0

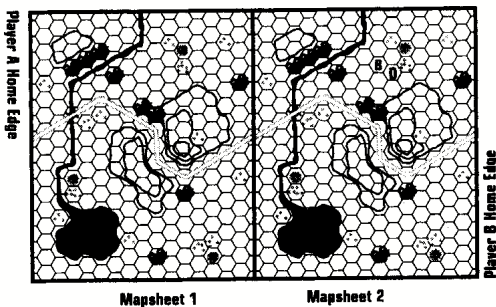



# BATTLEFORCE

## RUNWAY TABLE

Unit Class	Minimum Runway Length
Spheroid DropShip	0
Light Fighter	4
Medium Fighter	6
Heavy Fighter	8
Aerodyne DropShip	10

### Launching

Grounded aerospace units cannot simply spring into the air in a single turn. In order to get its engines up to speed for a launch, an aerospace unit must spend one Movement Phase revving them up. In subsequent Movement Phases, the unit may either launch as described below or continue to rev its engines.

On the support map, an aerospace unit launches in place of its normal Movement, and cannot attack during the turn in which it launches. After launching, a spheroid DropShip stays in the box in which it started; other aerospace units move immediately after launching. In subsequent turns, the airborne unit moves normally.

On the main map, launching is simple for spheroid DropShips. The ship stays in the same hex while launching, cannot attack in that turn, and moves normally in subsequent turns. Other aerospace units need a runway in order to launch, with the same length and terrain restrictions as the runway required to land (see **Landing**, above). The runway must extend in the direction the unit is facing; the unit cannot make facing changes or taxi in the same phase in which it launches. The launching unit moves down the runway and becomes airborne when it reaches the runway's end. It may also move normally in that same turn.

### ATTACKS

In **BattleForce**, aerospace units may make five types of attacks: striking, strafing, bombing, air-to-air and ground-to-ground. Each type of attack is described below in detail, but all share the following common rules.

Some fighters have Overheat Values, which work in exactly the same way as for BattleMechs. If a fighter element shuts down from overheating, it is immediately destroyed. DropShips cannot overheat.

Spheroid DropShips cannot attack unless they are on the ground, and may only make ground-to-ground and ground-to-air attacks. Each spheroid DropShip has two sets of Damage

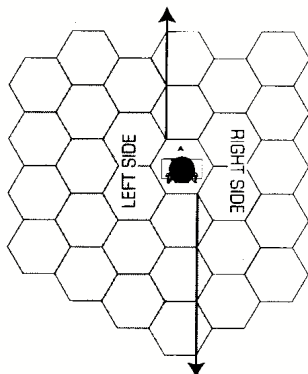

Values—one for weapons on the right side and one for weapons on the left side—and can make two attacks each turn. The firing arcs into which the right-side and left-side weapons can fire are shown in the left column on this page.

Aerodyne DropShips have one set of Damage Values, but can attack twice into the firing arc shown below using those Damage Values. Aerodyne DropShips may not make bombing attacks. All other aerospace units have a single set of Damage Values, and can attack into the firing arc shown below whether in the air or grounded.

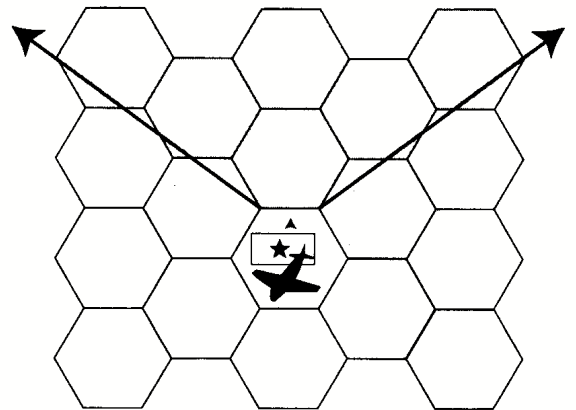

### Striking

The striking attack is an elementary and extremely accurate air-to-ground attack in which each craft fires all its weapons at a single target. A unit making a striking attack chooses one target unit; then each element of the attacking unit makes a single attack against a chosen target element, following the same rules as ground units regarding range, to-hit numbers, damage and so on. Aerospace units have a more limited firing arc than BattleMechs, as shown in the diagram above. However, a BattleMech's line-of-sight limitations do not apply to aerospace units. No kind of terrain will block LOS from an aircraft, though the terrain in the target hex still modifies the to-hit number per standard rules.

### Strafing

The most common type of aerospace attack is the strafing run, in which the craft fires its weapons repeatedly at the ground to saturate a line of hexes. This kind of attack is most useful against masses of infantry, as it inflicts little damage but can hit many units. The line of hexes hit by the strafing run can be any length the attacking player desires, from a single hex to a number of hexes equal to the attacking unit's medium-range Damage Value. The player must announce the length of the strafe at the beginning of the attack, which he does by moving the strafing unit through the hexes to be attacked.

The strafing run starts in the hex occupied by the attacking unit at the start of the Combat Phase, and continues in the direction the unit is facing until it reaches the hex to which the unit was just moved. The attack strikes every unit in the hexes strafed, whether friend or foe. Every element of every unit in the strafed hexes is attacked separately as if at medium range from the attacker. The to-hit number for each attack is calculated

# BATTLEFORCE

normally, except that the attacker's skill modifier is not applied. Each target hit by the strafe takes a single point of damage.

## Bombing

The least common type of air-to-ground attack, bombing is also the most deadly. A good pilot can deliver several tons of ordnance into a relatively small area and cause extreme damage.

Fighters may carry the following types of bombs, and may carry several types at once.

**High Explosive (HE):** Each HE bomb inflicts 2 points of damage on all elements of all units in the target hex.

**Cluster:** Each cluster bomb inflicts 1 point of damage on all elements of all units in the hex of impact and in the surrounding 6 hexes.

**Inferno:** One inferno bomb creates fires in the hex of impact and in the surrounding 6 hexes (even in Clear or Water hexes). Use the **Fire** rules on p. 48 to determine the effects of the fire.

**Mines:** Similar to Thunder submunitions, a mine-type bomb lays a minefield in the hex of impact. For more information, see **Mines**, p. 49.

Fighter units can deliver bombs in the hex they are in or can spread bombs along a strip of ground, much like a strafing run. If a player intends his fighters to drop bombs along a line of hexes, he must move the attacking unit in the same way as for a strafing attack. The unit must drop at least one bomb in every hex along the attack line. Because a fighter cannot skip hexes in the line, the maximum possible length of the bombing line is equal to the total number of bombs carried by both fighters in the bombing unit. The attacking player must declare the number and type of bombs to be delivered to each target hex before making any to-hit rolls.

Make a to-hit roll with a Base To-Hit Number of 8 for each hex into which bombs are dropped. Terrain modifiers do not apply; the attacking unit's skill modifier, however, does. If the to-hit roll is successful, all bombs dropped into the designated target hex explode in that hex. If the roll fails, the bombs scatter before exploding. To determine the direction of scatter, roll 1D6 for each bomb dropped and consult the Bombing Scatter Diagram below. Then make a second 1D6 roll and divide the result by two, rounding up, to determine the distance in hexes that the bombs rolled from the target hex. A result of 1-2 indi-

cates a one-hex scatter, 3-4 indicates two hexes and 5-6 indicates three hexes. The hex to which the bombs scatter becomes the impact hex, and the exploding bomb does damage to any units in that hex.

## Air-to-Air

Air-to-air attacks are made in the same way as other types of attacks. Use the firing arc shown on p. 40 and normal rules for determining to-hit numbers. All aerospace units always have LOS to all other aerospace units on the map, regardless of terrain. Also, terrain modifiers do not affect to-hit numbers.

## Ground-to-Ground

Grounded aerospace units can make attacks, though they are limited by their lack of maneuverability. A grounded DropShip can nonetheless be a significant force on the battlefield, simply because its big guns can do considerable damage.

Grounded aerospace units use the same rules as ground units for making attacks. However, because no unit can occupy the same hex as a DropShip, the pointblank range for DropShips extends 1 hex away from the hex the vessel occupies. Medium and long ranges remain the same.

Attacks against grounded aerospace elements follow standard LOS rules and use a Base Target Number of 0, regardless of the target element's MP. All other standard modifiers apply.

## Ground-to-Air

Ground units and grounded aerospace units can attack aerospace units in the air. Standard rules for resolving attacks apply, except that grounded units cannot make pointblank attacks against airborne targets. Even if the target is in the same hex as the attacker, the attack is considered to be at medium range. VTOL units are considered ground units for this purpose.

## ARTILLERY

Artillery elements (indicated on the record sheet by the abbreviation "art") can make artillery attacks. In basic **BattleForce** play, these attacks work just like indirect fire attacks. However, artillery can hit targets much farther away than eight hexes.

The Off-Board Units rules (p. 37) must be used in conjunction with these artillery rules.

Artillery attacks are directed against hexes, as opposed to against units and the elements in them. The target of an artillery attack is either a single hex on the **BattleForce** map or a single ground unit in a box on the support map. Artillery attacks cannot be directed against units in the air.

## SETUP

Artillery units are deployed in the same way as other units. Before setup, each player may secretly choose a certain number of hexes on the map as "designated targets." Support map boxes or specific units may not be designated targets. Each player may choose a number of designated targets equal to the number of artillery elements he possesses. The players designate their artillery target hexes after each player has chosen his home map edge but before any objectives are placed on the map.

**RIPPLE BOMBING SCATTER DIAGRAM**

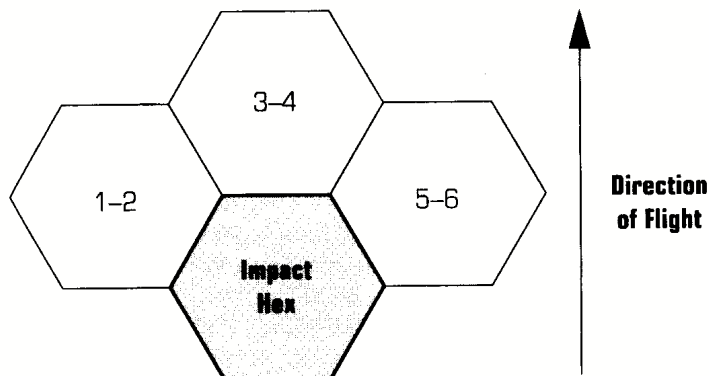

# BATTLEFORCE

Any artillery attacks aimed at a designated target hex automatically hit that hex, with no to-hit roll or scatter. This rule does not apply to Arrow IV attacks guided by TAG because those attacks are directed at individual elements rather than hexes.

## RANGE

The first step in making an artillery attack is to determine the range to the desired target. Range for artillery attacks is always expressed in mapsheets rather than hexes.

If the target hex is 0 to 16 hexes from the artillery unit, the range is zero mapsheets. If the target is 17 or more hexes away, the range in mapsheets will be 1 or more. For purposes of making attacks, the range is the number of mapsheets to the target, including the mapsheet the target occupies but not the mapsheet the attacker occupies. Units on the unnumbered hexes between two mapsheets are considered to be on the mapsheet furthest from the attacker.

The Artillery Range Table shows the maximum range of each artillery type. An artillery unit cannot make an attack beyond its maximum range. The type of artillery carried by an element will be indicated on the record sheet, either in its name or as a special ability. If no type is given for an artillery element, assume it is Arrow IV.

## ARTILLERY RANGE TABLE

Artillery Type	Maximum Range
Arrow IV	2
Long Tom	7
Sniper	4
Thumper	5

## Attacker or Target on Support Map

If the attacker or target is on the support map, the attacking player must add support map boxes when determining the range to the target. In this case, the range is equal to the box number the attacker or target occupies plus the appropriate mapsheets in the play area.

## Attacker and Target on Support Map

If the target is on the same side of the support map as the attacker, count the range in boxes to the target (not including the box occupied by the attacker) to determine range. If the target and attacker are on opposite sides of the support map, the range is equal to the number of the box the attacker occupies

plus the number of the box occupied by the target, plus 1 for every mapsheet that the play area is wide, minus 1.

*Looking at the play area mapsheets and support map makes it simple to count artillery ranges. Just count the total number of boxes and mapsheets from the attacker to the target. The diagram above shows some examples of artillery range. Each letter indicates an artillery unit. The ranges from each unit to each other unit are shown below. The range from Hex B to Hex E is counted as 1 mapsheet, because the two units are more than 16 hexes apart.*

Attacker	Target					
	A	B	C	D	E	F
A	0	3	9	3	2	5
B	3	0	6	0	1	8
C	9	6	0	6	7	14
D	3	0	6	0	1	8
E	2	1	7	1	0	7
F	5	8	14	8	7	0

## TARGETING

An artillery unit may fire if it has a target in range. An artillery element may use its standard Attack Values to make a normal attack, or may make an artillery shot using its long-range Attack Value. However, it may not make both types of attack in the same turn.

## Time in Flight

If the range is greater than zero, the shot will take a number of turns to reach the target, as shown on the Time in Flight Table. If the shot will not land during the turn in which it is fired, the attacking player must write down the target hex and its mapsheet and conceal this information from his opponent.

## TIME IN FLIGHT TABLE

Range	Time in Flight
0	0 (lands during the turn in which it is fired)
1-2	1 (lands during the turn after it was fired)
3-4	2 (lands during the second turn after it was fired)
5-6	3 (lands during the third turn after it was fired)
7-8	4 (lands during the fourth turn after it was fired)

## To-Hit Roll

After the appropriate time in flight, the artillery attack lands and the attacking player makes a 2D6 to-hit roll. Regardless of time in flight, all artillery attacks are resolved at the end of the attacker's Weapon Attack Phase, after all other attacks have been resolved.

The Base To-Hit Number for an artillery attack is 11. Only the firing element's skill modifier applies to this attack. No other modifiers apply except those for adjusting fire, if appropriate (see **Adjusting Fire**, p. 43). Unlike standard attacks, a to-hit roll result of 12 for an artillery attack does not result in an automatic hit. However, a result of 2 is still an automatic miss, regardless of skill or adjusting fire modifiers.

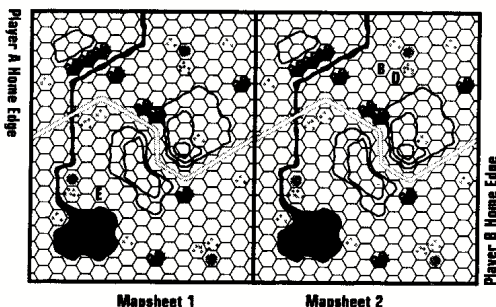
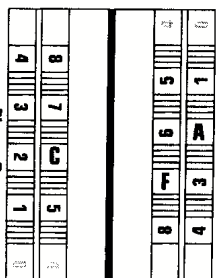

# BATTLEFORCE

If the to-hit roll result equals or exceeds the modified to-hit number, the attack hits the target hex; otherwise, the shot scatters. To determine where the scattered shot lands, first roll a die to determine the scatter direction per the Scatter Diagram. Then roll a second die to determine the distance that the shot scatters. On a result of 1–3, the shot scatters one hex in the indicated direction; a result of 4–6 scatters the shot two hexes in the indicated direction.

Once an artillery element hits its target hex, its subsequent attacks against that same hex hit automatically.

Artillery attacks against units on the support map do not scatter. A successful to-hit roll means that the attack hits the targeted unit. If the roll is unsuccessful, the attack misses.

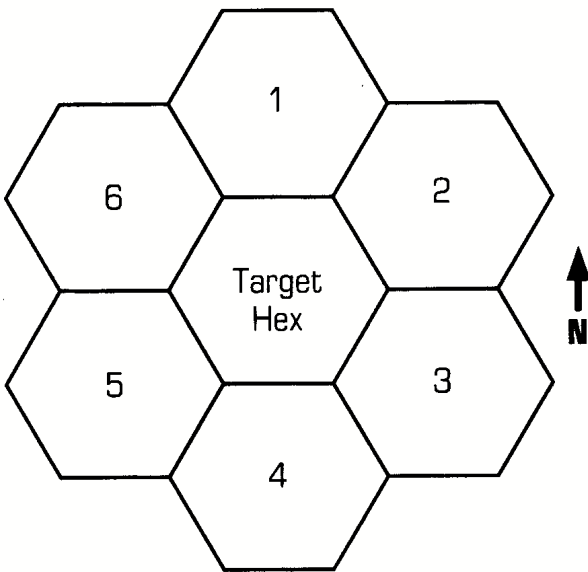

## Adjusting Fire

If the target hex of an artillery attack is in a friendly unit's line of sight when the shot lands, the artillery element may adjust subsequent shots against the same hex. Each subsequent shot fired at the targeted hex reduces the to-hit number by 1. This reduction applies only to subsequent shots fired, not to shots aimed at the hex that are already in flight.

## TAG Spotting and Arrow IV Targeting

Target acquisition gear (TAG) consists of a special laser used to designate targets for Arrow IV artillery attacks. TAG only aids Arrow IV attacks (elements designated "artA"). Other types of artillery do not benefit from TAG.

A TAG-equipped element may attempt to guide an Arrow IV attack in the turn in which the attack arrives on the playing area. The target must be on the same mapsheet as the target hex that the attacking player wrote down, though it need not occupy the designated target hex. The TAG-equipped element must have LOS to the target and be within medium range (4 hexes).

TAG targets a single element, as opposed to an entire hex. The target may be any type of element except infantry. The TAG-equipped element acts as a spotter for the artillery unit instead of making a standard attack for the turn. Calculate the to-hit number as for a standard attack, applying all appropriate

combat modifiers. If the to-hit roll is successful, the TAG-equipped spotter successfully designates the target. At that point, the player rolls 2D6 for the Arrow IV attack. On a result of 4 or higher, with no modifiers applied to the result, the missile hits the target. If the spotting to-hit roll or the Arrow IV to-hit roll fails, the attack misses and does not scatter.

A single TAG-equipped element can spot for any number of Arrow IV attacks that arrive in the same Combat Phase against the same target. Only a single spotting roll is required; however, the player must make a separate to-hit roll for each Arrow IV attack.

## DAMAGE

Artillery attacks directed against a hex on the map do damage to all elements of all units in the hex where the shot lands. The damage is equal to the attacking element's long-range Attack Value, and can be increased by overheating per standard overheating rules (see p. 25). No extra damage results from the attack direction (see **Attack Direction**, p. 25).

Artillery attacks directed against a unit on the support map damage that unit only, but affect all elements of that unit equally. Such attacks do no damage to other units in the same box as the target unit.

## TAG and Arrow IV Damage

An Arrow IV attack guided by TAG only damages the element targeted by TAG. The attack does not affect other elements in the target unit. The attack direction is based on the location of the spotter unit, which results in an extra point of damage if the TAG-equipped spotter is behind the target (see **Attack Direction**).

## BUILDINGS

Historically, the abundant buildings and similar obstacles in urban areas made it difficult for armored vehicles to successfully fulfill their battlefield objectives, and cities in the thirty-first century still cause problems for BattleMechs. Battles fought in long, narrow streets filled with buildings that block line of sight, provide enemy hiding places and offer limited protection from weapons fire require a change in tactics and operations. In urban combat, even unarmored infantry may substantially damage a BattleMech.

## BUILDING TYPES

Buildings in **BattleForce** are divided into three broad categories: Base, City and Fortress. Each building counter represents a small group of buildings rather than an individual structure. The Building Table summarizes important information about the three types of buildings.

### Base

Base counters represent groups of short, light buildings: tents and other temporary structures found on a battlefield, as well as small family homes or businesses.

### City

City counters represent groups of moderate-sized buildings that comprise the bulk of most settlements in the Inner Sphere.

# BATTLEFORCE

## Fortress

Fortress counters represent groups of large, heavy buildings such as factories and fortifications.

**BUILDING TABLE**

Building Type	MP to Enter*	Strength	Weight Limit	Affects LOS as
Base	2	12	L, M	Clear
City	3	14	L, M, H	Light Woods
Fortress	4	16	L, M, H, A	Heavy Woods

\* Infantry only pay 1 MP to enter Building hexes.

## MOVEMENT EFFECTS

Building hexes are more difficult to move through than Clear terrain, as shown by the MP to Enter column on the Building Table. The additional MP cost reflects the time it takes to move around or enter each building in order to get through the hex. Because infantry units have an easier time moving through streets and buildings, they pay no additional MP.

When a unit occupies a Building hex, it is normally assumed to be among the buildings in the hex. Therefore, the unit is not considered to be at a higher elevation than the hex it occupies.

## Climbing Buildings

A BattleMech or infantry unit can move to the roof of a building rather than staying on the ground, in order to gain a better vantage point over the battlefield.

The Weight Limit column on the Building Table indicates the weight classes that each type of building can support (infantry can climb to the top of any building). The weight limit applies to the weight class of the entire unit rather than individual elements in the unit. If the unit exceeds the weight limit, it may not climb the building.

If the unit is within the buildings' weight limit, the controlling player announces when the unit enters the hex that it is climbing the buildings rather than staying at ground level. If desired, a die or coin can be placed on the unit counter to remind all players that the unit is on top of a building in the hex. While atop the building, the unit is considered to be at one elevation level higher than the hex.

A BattleMech unit on top of a building does not gain the defensive terrain bonus of the buildings in the hex it occupies. Infantry units do, because they occupy the top floor of the building rather than literally standing on its roof in the open. Climbing down from a building costs the same MP as entering the hex.

## COMBAT EFFECTS

Building hexes affect LOS and to-hit numbers in the same way as Woods hexes. See the Building Table for each type of building's specific LOS effects.

## Attacking Buildings

Like units, buildings can be attacked. Because they are large, immobile targets, the Base To-Hit Number for an attack against a building is 0. Apply other modifiers as appropriate, including the terrain bonus for the Building hex itself (if any).

Each attack that hits the building may reduce it to rubble. After each successful attack, roll 2D6 and add to the result the amount of damage inflicted by the attack. If the total is equal to or greater than the building's Strength (shown on the Building Table), the building collapses into rubble. A total result lower than the building's Strength has no effect. To indicate that a group of buildings has been reduced to rubble, turn the building counter over.

Any units that have climbed onto the building when it collapses will take damage equal to the MP cost to enter the Building hex (so larger buildings inflict more damage). The damage applies to each element of each unit inside or on top of the building. Units in a Building hex that have not climbed a building take no damage when the building is destroyed.

## Infantry in Buildings

Infantry that have climbed a building are inside the building's top floor. Because they are inside the structure, they cannot be attacked directly, though an infantry unit can attack targets outside the building normally. To damage an infantry unit inside a building, an attacker must destroy the building or hit the hex with an artillery attack. In the latter case, all units in the target hex take damage, including the building and the infantry inside it.

## Armed Buildings

Fortresses can be equipped with weapons that give the building Damage Values corresponding to a combat element's statistics. Buildings, like conventional vehicles, cannot overheat. Unless otherwise stated in the scenario rules, a building has a 360-degree arc of fire and can make one attack per turn.

The scenario being played will set specific Damage Values for buildings when they are needed. If players wish to include a "generic" gun emplacement in a scenario, assume that the gun emplacement has Damage Values of 2 at all ranges.

## CLAN HONOR

When Nicholas Kerensky created the society known as the Clans more than two centuries ago, he faced an interesting problem: how to turn an army of Star League military refugees into a functioning society while maintaining their fighting edge in preparation for their eventual return to the Inner Sphere. The Clan homeworlds' remoteness and general lack of resources added to the problem; though they needed copious amounts of military hardware to remain a viable fighting force, Kerensky and his newborn Clans could not afford to waste anything.

Kerensky's solution was as ingenious as it was bizarre. He created a caste-based society with the warrior caste at the top of the heap. Warriors had the greatest power and also the greatest responsibility of all the Clan castes. Furthermore, not just anyone could be a warrior. Through rigorous training and grueling tests, only the very finest fighters and tacticians could earn that coveted title. Those who failed to make the cut were relegated to the lower scientist, technician and laborer castes—stations vital to Clan society but without the power and prestige of warriors.

To reduce the waste associated with war while guaranteeing that each generation would keep honing its combat edge, Kerensky codified the practice of warfare into a series of combat trials, each associated with a particular goal. The Trial of

# BATTLEFORCE

Possession is the most basic trial, in which one warrior or Clan aims to possess something that belongs to another. Other trials include Trials of Grievance, Refusal, Bloodright and Annihilation.

In any trial, the two sides fight a ritualized battle—sometimes hand-to-hand, sometimes full-scale BattleMech combat. Trials are fought in a clearly defined area known as the Circle of Equals, usually located away from populated areas so as to inflict as few civilian casualties and as little collateral damage as possible.

The prospective combatants then further reduce the scale of battle by bidding. Every conflict begins with the *batchall*, in which the defending force is clearly announced to the attacker. The commanders among the attacking force then proceed to bid with each other for the right to attack the target. The commander who bids the smallest and least powerful force is awarded the honor of making the attack. By ensuring that the smallest possible attacking force will be used to take the objective, the bidding process limits the loss of warriors and materiel.

Once battle is joined, the warriors begin the ritual of *zellbrigen*, or dueling. Each warrior challenges a single opposing warrior to a duel, and the two fight each other one-on-one. No other combatants on the field will join in such a battle; doing so is a serious breach of honor. In fact, if one side in a battle outnumbers the other, the excess warriors will stand by without interfering; they will enter the fray only when one of their comrades falls. In rare circumstances a breach of Clan honor may touch off a melee, where all units on the field may freely fire on the opposing side. However, the Clans usually reserve this barbaric practice for opponents they consider dishonorable, such as pirates and mercenaries.

When the Clans came to the Inner Sphere, they brought with them their hundreds-of-years-old traditions. At first, the Clans' unusual tactics went without notice as their powerful OmniMechs plowed through rank after rank of Inner Sphere BattleMechs. However, a perceptive Inner Sphere commander can spot the weaknesses in Clan fighting strategy and exploit them to his advantage, thereby narrowing the gap created by the Clans' advanced weapons and training. Such was the case at the famous battles of Twycross, Wolcott and Tukayyid, in which massive Clan offensives were blunted by the crafty strategic thinking of Inner Sphere commanders.

## GAME USE

The Clan code of honor, also known as "rules of engagement," is described in detail on pages 40–42 of **First Strike!**, including specific guidelines for *zellbrigen*, physical attacks and retreat, as well as detailed honor levels for use in **BattleTech** game play.

In **BattleForce**, the various rules of engagement are merged into a single game effect for the sake of simplicity. In a given scenario, the Clan side is either restricted by Clan honor or not. All of the following rules apply to the Clan side (or sides) only if Clan honor is in effect. The status of Clan units does not change during game play; the rules assume that individual breaches of Clan honor occur but are insignificant compared to the scope of the overall battle.

Using Clan honor puts Clan units at a distinct disadvantage. To compensate, when following Clan honor rules, reduce

the skill modifiers for all Clan BattleMech elements by 1 to reflect the advanced training given to Clan MechWarriors. For example, Regular pilots with +0 Skill Modifiers have –1 Skill Modifiers instead. This reduction does not apply to elements other than 'Mechs.

## Zellbrigen (Dueling)

When announcing attacks for a unit, only one element may attack any given element in the target unit. In practice, this often means that an element in the attacking unit may not attack at all. The attacking element is chosen as each unit declares its attacks; players need not keep track of this restriction from one unit to the next unless the game is very small or they wish to do so. In a large game, remembering which enemy elements were attacked and which ones were not can quickly become more trouble than it is worth.

## Physical Attacks

In order to represent Clan MechWarriors' traditional disdain for physical attacks, BattleMech elements reduce their pointblank Damage Values. Light and medium 'Mechs reduce their pointblank Damage Values by 1; heavy and assault 'Mechs reduce their pointblank Damage Values by 2. Provided that the 'Mech has a pointblank Damage Value to begin with, the minimum reduced pointblank value is 1.

The reduction does not apply to elements other than 'Mechs.

## Retreat

Unless otherwise stated in the scenario rules, Clan units may not withdraw from battle against Inner Sphere opponents. If the Off-Board Units rules (p. 37) are in effect, Clan units can enter and leave the support map in the same way as other units, but cannot leave play entirely.

## CLEARING WOODS

Units can use heavy weapons fire to clear wooded hexes, though an attempt to do so may set the woods on fire by accident (see **Fire**, p. 48). Woods can be reduced from Heavy to Light or cleared completely, though the fallen trees convert the hex to Rough rather than Clear terrain.

Only BattleMech and vehicle elements can attempt to clear a Woods hex. An element must have a Damage Value of at least 2 to have any chance of clearing the hex. When a player wants his BattleMech or vehicle to clear a wooded hex, he declares that hex as the element's target during the Attack Phase. The attack is resolved in the same way as an attack against a building (see **Buildings**, p. 43). The Base To-Hit Number for the attack is 0, modified as normal for range and so on. Modifiers for the woods in the target hex do not apply.

A successful clearing attack results in a second roll against the hex's Strength (always 14). Roll 2D6 and add the Damage Value of the element making the attack to the result. If the total is 14 or more, the attack converts the wooded hex to Light Woods or Rough terrain, per the Terrain Conversion Table. A result of less than 14 has no effect.

# BATTLEFORCE

## TERRAIN CONVERSION TABLE

Original Terrain	New Terrain
Heavy Woods	Light Woods
Light Woods	Rough
All others	No change

## ENGINEERING VEHICLES

Engineering vehicles (elements marked "eng" on the record sheet) can attempt to clear terrain with no risk of accidentally setting fires. The vehicle must be in or adjacent to the Woods hex it wants to clear, and may not move or attack during the turn in which it is clearing woods. No to-hit roll is required to clear woods; the controlling player simply rolls 2D6 and adds 6 to the result. If the total is 14 or more, the Woods hex is cleared as described above.

## CONCEALED UNITS

In order to add more realism and suspense to game play, a player can conceal the specific identity of units from his opponent, requiring the opponent to send out scouts to determine the units' exact type. In addition, players may hide the location of units on the map, forcing the other player to search for those units or stumble into a trap.

Concealed units rules fall into two distinct categories: concealed identity rules and hidden units rules. Units with concealed identity have their counters flipped to the back side at the start of play to conceal their specific type from the opposing player. Counters for hidden units are not placed on the map at the start of play; instead, their controlling player writes down their location and keeps it secret. Hidden units are only revealed if they are discovered.

## CONCEALED IDENTITY

When using the concealed identity rules, all concealed units begin play with their counters turned so the back sides show. Such face-down units are referred to as unidentified. Only each unit's general type ('Mech, vehicle and so on) is known to the opposing player at the start of play. Once a unit is identified, its counter is flipped face-up and stays that way for the remainder of the game. Because record sheets for all units are customarily kept hidden from the opposing player, an opponent can only discover the specific identity of face-down units if those units make an attack or occupy the same hex as an enemy unit, or by scanning for concealed units.

Unidentified units may move using their normal MP and terrain restrictions. However, a player may use less than the unit's maximum MP in order to trick his opponent into thinking the unit is slower than it really is.

If any element of an unidentified unit makes an attack, the unit counter is immediately flipped face-up and the unit is identified. An unidentified unit in the same hex as an enemy unit is immediately identified.

## ECM Jamming

A unit containing one or more elements equipped with ECM can further conceal its identity by jamming enemy sensors. For each jamming unit, the controlling player places an

ECM counter on top of the unit counter at the start of play; this action conceals the unit's general as well as its specific type from the opposing player. However, the opponent will know that the concealed unit contains at least one ECM-equipped element. The ECM counter stays in place until the concealed unit attacks or is otherwise identified, as described below.

ECM jamming must be announced and counters placed at the start of play. Players may not replace ECM counters on units once they are removed, nor may they add ECM counters during play.

## Scanning

Every type of unit has a set of sensors that allow it to scan nearby units to determine their identity. Scanning is done during the Combat Phase. Just before a unit announces its attacks, it may make one scanning attempt against a single, unidentified enemy unit within long range (8 hexes).

The Base Target Number for a scanning attempt is 8, modified by -2 if one or more elements in the scanning unit has an active probe. If there is one or more ECM-equipped enemy elements in the target unit, adjacent to the target unit, adjacent to the scanning unit or along the LOS to the target unit, the target number is modified by +2. The scanning player rolls 2D6. If the result is equal to or greater than the modified target number, the scan succeeds and the target is identified.

If the target was using ECM to jam enemy sensors, the ECM counter is removed, but the target unit remains unidentified. It must be successfully scanned again or otherwise identified before its counter is flipped over.

## Attacking Unidentified Units

Players may launch attacks at an unidentified unit, but will be firing blind. When a player declares an attack against an unidentified unit, the target player need only state how many elements the attacker has to choose from. The attacker must then declare all of the attacks for his unit, choosing target elements based on their position in the target unit on the record sheet. For example, an attack against Element 1 would be directed against the element listed at the top of the target unit's record sheet. An attack against Element 3 would strike the third element from the top.

## Concealed Off-Board Units

Units on the support map are not immediately identified by enemy units in the same box, but must be scanned to be identified. In all other respects, concealed off-board units are treated in the same way as other concealed units.

## HIDDEN UNITS

At the start of a game, each side may hide on the map a number of units determined by the scenario being played or agreed to by all players. Players should write down the number of each hex in which a unit is hidden and designate the unit's facing. BattleMech units cannot be hidden in Clear or Paved hexes. Otherwise, units may be hidden in any hexes desired.

Hidden units remain hidden until they attack or move, or until an enemy unit moves into their hex or ends its movement adjacent to their hex. A unit with an active probe will reveal a hidden unit if the hidden unit lies within medium range (4 hexes) at the end of the probe-equipped unit's movement.

If a unit enters a hex containing a hidden unit, the moving unit immediately ends its movement and the hidden unit is revealed. This rule does not apply to VTOLs flying or units jumping over a hex that contains a hidden unit. The moving unit must be moving along the ground or must be ending its move in the hex with the hidden unit in order to discover the unit.

When a hidden unit is revealed, its counter is placed on the map face-down, and the unit is treated as concealed per the concealed identity rules. A just-revealed unit with ECM may not begin jamming in the same turn that it is revealed.

## Surprise Attacks from Hidden Units

When an enemy unit moves into or ends its movement adjacent to a hex occupied by a hidden unit, or in a hex occupied by a hidden unit, the hidden unit may immediately make a surprise attack provided that the unit has a valid firing arc to the target. Each element in the hidden unit may make one attack. Terrain modifiers do not apply. Any damage takes effect immediately during the Movement Phase, and the results may affect the target unit's actions for the rest of the phase. A unit making a surprise attack may not move, fire again or perform any other action for the remainder of that turn.

## Off-Board Hidden Units

Players may hide units off-board in boxes on the support map, though there is rarely reason to do so. Like other hidden units, they are revealed if they move or attack, or if an enemy unit ends its movement in the same box with them. Hidden units on the support map may not make surprise attacks.

## DROPPING TROOPS

Normally, troops enter a battlefield by advancing over ground to the target. In some cases, however, troops achieve the elements of speed and surprise through an assault drop. Such a maneuver requires troops to drop from a DropShip while it is in flight, either in space or in the atmosphere. The troops wear special jump packs that allow them to descend to the planet's surface in relative safety. Dropping troops is most often used in scenarios as an alternative method of landing troops on a **BattleForce** mapsheet.

Complete rules for dropping troops appear in the **BattleSpace** rulebook. The following paragraphs provide a simplified version of those rules. Only BattleMechs and battle armor-equipped infantry may make assault drops.

The player controlling the dropping troops designates a hex on the mapsheet in which each unit will land. For each unit, the player then makes a 2D6 roll to determine whether the landing was successful. The Base Target Number for a successful landing is 5, modified by the worst skill modifier in the unit. If the result is equal to or greater than the modified target number, the landing succeeds. A failed roll means the landing failed and the unit missed its target hex.

Each element of the unit takes damage from a failed landing equal to the margin of failure on the landing roll. For example, if the dropping unit needed a 5 and rolled a 3, each element would suffer 2 points of damage ( $5 - 3 = 2$ ).

On a failed landing, the unit also "scatters" one hex for every point by which the landing roll result falls below the modified target number. Use the Scatter Diagram for **Artillery**, p. 43, to determine the direction of scatter. If the unit scatters into ter-

rain that it is prohibited from entering, it is destroyed. If the scatter result indicates that the unit will land in a hex that would violate the stacking rules (for example, a friendly unit is occupying the hex already), the unit in the hex is forced out of the hex. Roll 1D6 to see which direction the forced-out unit goes, using the scatter diagram. The forced-out unit will move one hex in the indicated direction, but suffers no additional effects and maintains its original facing. If the result of the scatter roll would move the unit into prohibited terrain or a hex containing units that would violate stacking limits, re-roll until the result is legitimate. If the unit cannot legitimately scatter anywhere, it remains in its original hex and the dropping unit is destroyed.

Dropped troops always land at the end of the controlling player's Movement Phase. They may not fire or otherwise act for the remainder of that turn, but may be fired upon. Landed units function normally thereafter.

## ENVIRONMENTAL CONDITIONS

Players may use the following rules to simulate combat in extreme temperatures, low gravity, difficult terrain or vacuum.

### EXTREME TEMPERATURES

Temperatures between  $-30$  and  $50$  degrees Celsius ( $-22^\circ$  and  $122^\circ$  Fahrenheit) have no impact on combat in **BattleForce**. However, fighting in significantly higher or lower temperatures affects the combat effectiveness of elements other than BattleMechs.

For vehicles and battle-armored infantry, reduce their MP by 1 for every  $10^\circ$  C (or fraction thereof) higher than  $50^\circ$  or lower than  $-30^\circ$ , to a minimum MP of 1. Unarmored infantry platoons cannot be deployed outside a vehicle or building in temperatures higher than  $50^\circ$  C or lower than  $-30^\circ$  C.

### ICE

Extreme cold ( $0^\circ$  C or less) can cause a body of water to freeze. The formation of ice may allow units to cross a Water hex more easily, though the ice may break and the units fall through. In addition, normal terrain can become coated with ice, making all movement across it treacherous. Prior to the start of the game, players should indicate which hexes are ice-coated.

The MP cost to enter an ice-coated hex increases by 1 for all types of units except infantry. Also, roads normally are not considered ice-coated even if they pass through an ice-coated hex, as they are assumed to be cleared of ice regularly unless otherwise specified by the scenario rules. Ice-coated Water hexes are considered Clear terrain (with the +1 MP cost for the ice) as long as nothing has broken through the ice.

Any BattleMech unit that ends jump movement on an ice-covered Water hex, or lands in such a hex using the Dropping Troops rules may break through the ice and fall into the water if the water in the hex is not frozen solid. Roll 1D6. On a result of 4 or more, the ice breaks and the unit plunges into the water. Each BattleMech element in the unit takes 1 point of damage, and the unit may not attack in the same turn. Units other than BattleMechs are destroyed if they fall into the water unless they are normally permitted to enter Water hexes (such as hovercraft and naval vehicles). Any other units in the hex will also fall into the water, and the Water hex remains unfrozen for the remainder of the game.



# BATTLEFORCE

Players should only use this breakthrough rule if they decide that the water in a hex is not frozen solid. Ground pressure, rather than the unit's weight class, determines whether or not a unit breaks through ice. Larger BattleMechs and vehicles have larger "footprints," and so their presence on ice exerts pressure per square meter as low as that of lighter units with smaller footprints.

An ice-covered Water hex can be converted into a normal Water hex by melting the ice with weapons fire, using the Clearing Woods rules, p. 45. Units occupying such a converted hex (except for hovercraft and VTOLs) fall into the water as described above.

## HIGH/LOW GRAVITY

Combat on worlds whose gravity is significantly higher or lower than normal Earth gravity (1 G) affects a unit's movement. As shown in the following rules, while low gravity generally allows units to move faster, it does not reduce their mass and momentum, and so units may risk damage through normal movement. For example, a BattleMech traveling 200 kph on a .5 G world is likely to snap off its legs.

Gravity affects the movement of all units the same way. To determine an element's movement rates as affected by gravity, divide its MP by the G-rating of the world and round to the nearest whole number (round .5 down). For example, an element with a normal MP of 4 has an MP of 5 on a .75 G world ( $4 \div .75 = 5.3$ , rounded to 5). On a 1.25-G world, that same element has an MP of 3 ( $4 \div 1.25 = 3.2$ , rounded to 3). Elements whose MP is reduced to 0 by the effects of gravity cannot move.

BattleMech legs and vehicle suspensions are designed to operate at maximum efficiency on worlds with close to 1 G gravity. If the gravity of a world allows the element to move faster than normal, the strain on the element's systems may damage its internal structure. If a unit spends more than its normal MP during a turn (as in the example above of the unit on a .75 G world), the controlling player must make a 2D6 roll against a Target Number 5 at the end of the Movement Phase to determine if any elements in the unit take damage from moving at an unusual rate. Only roll for elements in the unit that exceeded their normal MP. Apply the element's skill modifier to the target number.

If the result is lower than the target number, the element takes 1 point of damage to its structure (bypassing armor in the case of BattleMech elements) for every point of movement by which the unit exceeded its normal MP. For example, a BattleMech element with a normal MP of 5 is part of a unit that spends 7 MP during a turn. If the 'Mech fails its 2D6 roll, it takes 2 points of structure damage. The player must also check for a critical hit (see **Critical Hits**, p. 26). If an element's structure is destroyed, the element is considered destroyed even if it has armor left.

## VACUUM

All BattleMechs can operate in a vacuum, though combat on an airless world poses many dangers. Exposing the inner workings of a BattleMech to a vacuum freezes actuators and makes weapon components fail.

In **BattleForce**, only BattleMechs and battle-armored infantry units can function in a vacuum. Other units cannot be deployed in a vacuum.

Every time a BattleMech element operating in a vacuum takes a hit, roll for a critical hit even if the 'Mech's armor is still intact. This roll represents the chance of a hull breach that can cause vital systems to freeze up. Battle armor infantry suffers no ill effects from operating in a vacuum.

## NIGHT COMBAT

A lack of ambient light degrades the ability of BattleMechs and other combat elements to target and hit an opposing element. If combat takes place at night, modify all to-hit numbers by +2. For dusk or twilight conditions, modify to-hit numbers by +1.

## FIRE

Many battles are decided not by the skill or abilities of the soldiers involved, but by the spread of fire across the battlefield. Players may use the following rules to simulate the effects of fire.

Use counters to show the presence of fire and smoke in particular hexes: either unused counters from the **BattleForce** boxed set or fire and smoke counters from the **CityTech, Second Edition** boxed set. Place a fire counter on any hex that is set on fire during the game. Once started, a fire burns for the rest of the game.

## STARTING FIRES

Hexes may be burning at the start of a scenario, but most fires are started accidentally or intentionally by units on the map during game play. BattleMechs carry many weapons that can start fires in wooded hexes and buildings. Once started, fires spread easily from hex to hex, producing heat build-up in BattleMechs moving through or standing in those hexes.

### Accidental Fires

Weapons powerful enough to smash a BattleMech with one blow can also do extensive collateral damage, the most devastating of which is fire. Players may use the following rules to represent accidental fires.

A unit attempting to clear a wooded hex (see **Clearing Woods**, p. 45) runs the risk of setting the woods on fire accidentally. To represent this risk, the player rolls 2D6 after a successful to-hit roll, but before rolling to see if the woods are cleared. On a result of 5 or lower, the woods have been accidentally set alight rather than cleared.

If an attack against a unit occupying a wooded hex misses its target, and the Damage Value of the attack is 2 or more, the attacking player rolls 2D6 to determine whether his attack accidentally set a fire or changed the terrain in the target's hex. On a result of 2 or 3, the hex catches fire. On a result of 11 or 12, roll another 2D6 against the Strength of the woods per the clearing woods rules to see if the woods are cleared.

A building cannot be accidentally set on fire.

### Intentional Fires

Players who intend to start fires may declare that an element will fire its weapons at any Woods or Building hex instead of making a standard attack. Any BattleMech or vehicle element with a Damage Value of 2 or more may attempt to start a fire, as can any infantry element equipped with flamers. Other infantry elements cannot attempt to start fires. The Base To-Hit Number for intentionally starting a fire is 0, modified per standard rules for range and so on. If the attack is successful, the

# BATTLEFORCE

player rolls 2D6 and consults the Fire Table to determine if the attack started a fire. If it did, place a fire counter on the target hex. Multiple successful attempts to start a fire do not make the fire larger.

FIRE TABLE		Dice Roll Result
<b>Hex Type</b>		
Woods		10+
Base		10+
City		11+
Fortress		12+
Other Terrain	Fire cannot start or spread	
<b>Modifier</b>		
Flamer Infantry		-2
<b>Spreading Fires</b>		
Hex is downwind		9+
Hex is 60° from downwind		11+
Fire crosses non-burning hex		+3

## EFFECTS OF FIRE

During the End Phase, the heat level of a BattleMech element occupying a burning hex rises by 1. A BattleMech element's heat level also rises by 1 if it moved into or out of one or more burning hexes during the Movement Phase. These effects are cumulative; for example, a 'Mech unit that moves into a burning hex and stays there will suffer an increase of 2 on the heat scale.

Elements other than BattleMechs have no heat scales; instead, they take damage from fire. Unless the controlling player makes a 2D6 roll with a result of 8 or higher, any non-BattleMech unit that ends its Movement Phase on the ground in a burning hex or moves along the ground through a burning hex takes 1 point of damage to each of its elements. The player must make this roll each time a unit meets either condition.

A unit occupying a hex ignited during the turn's Attack Phase will not be affected by the fire until the End Phase of the following turn.

## Buildings

During the End Phase, check the status of each Building hex that is on fire. Roll 2D6 for each hex and add 4 to the result. If the total is equal to or greater than the Strength of the buildings in a particular hex, those buildings are destroyed by the fire. Otherwise, the buildings continue to burn.

## SPREADING FIRES

Fires on the battlefield can spread from hex to hex through Woods and Building hexes, driven by the direction of the wind.

## Determining Wind Direction

At the beginning of the game, declare one side of a hex on the mapsheet to be Direction 1. Then number the remaining hexsides 2 through 6, moving clockwise. Finally, roll 1D6. The wind will blow in the direction indicated by the die roll result for the entire game.

## Determining Spread

During the End Phase of every turn, check to see if any fires currently on the map spread to additional hexes. Roll 2D6 for the adjacent hex directly downwind of a fire hex. If the result is 9 or higher, and if the hex can burn (see the Fire Table), the fire spreads into that hex. Make another 2D6 roll for each of the two hexes adjacent to the burning hex at 60 degrees from downwind. If the result is 11 or higher and the hexes can burn, the fire will spread into those hexes as well.

A flammable hex directly downwind from a fire but separated from it by a non-burning hex may also catch fire. Roll 2D6. On a result of 12, the fire spreads to a flammable hex directly downwind from a fire.

If a single hex can catch fire because of its relationship to several burning hexes, roll for each possibility.

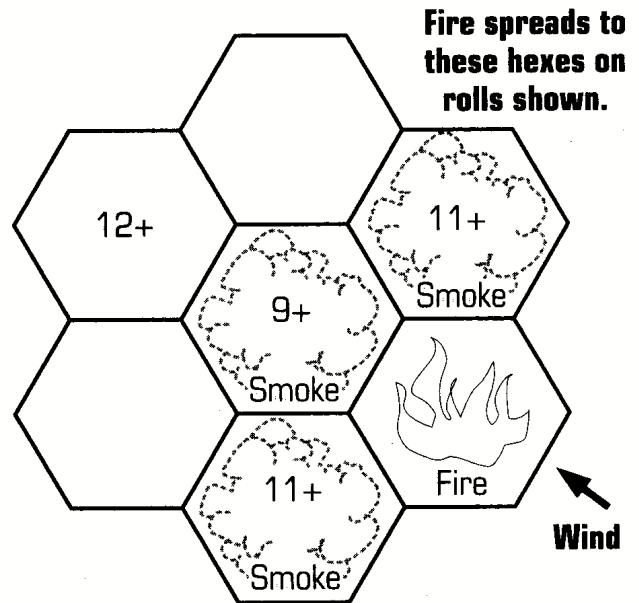

## SMOKE

A fire spreads smoke to the adjacent hex downwind and to the two adjacent hexes 60 degrees from downwind (that is, the three adjacent hexes of the fire's forward arc). The fire does not create smoke in its own hex (though a fire upwind from that hex may do so). Treat a smoke-filled hex as Heavy Woods when determining line of sight and to-hit modifiers.

## MINEFIELDS

Though several types of minefields exist in the **BattleTech** universe, the **BattleForce** rules assume they all have the same net effect on larger-scale game play. Therefore, all minefields work the same way in **BattleForce** games.

## SETUP

Players assign minefields to hexes during game setup, after the players have chosen their home map edges and before placing their objectives on the map, secretly noting the location of each field. The number of minefields available to each player may be determined by the scenario or agreed upon by all players before beginning play. Though some scenarios

# BATTLEFORCE

may designate minefield locations, only the referee or controlling player should know those locations.

## Thunder Munitions

Long-range missile launchers and Clan Arrow IV artillery systems can be loaded with special FASCAM (Field Artillery Scatterable Mines) ammunition, commonly known as Thunder munitions, that allow them to deliver minefields to a target hex instead of having their usual effects.

Any element capable of indirect fire (marked as "if" on the record sheet) may be designated as carrying Thunder munitions, as may any Clan element armed with the Arrow IV system (marked as "artA"). Inner Sphere Arrow IV elements may not use this option. Each element so armed reduces all of its Damage Values by 1. For example, an element with Damage Values of 6, 4 and 2 would have Damage Values of 5, 3 and 1 when armed with Thunder munitions. Clearly mark the record sheet for every element armed with Thunder munitions.

The Thunder-armed element can either make a normal attack using its modified Damage Values or it can launch a minefield instead. The Thunder attack is resolved in the same way as an artillery attack, as it is directed at a hex rather than an element (see **Artillery**, p. 41). The range of such an attack is restricted by the armament available to the element; for example, an element capable of indirect fire can target hexes up to long range, while an Arrow IV-equipped element can target hexes up to 2 mapsheets away. A missed attack scatters in the same way as an artillery attack. The impact hex thereafter contains a standard minefield.

## DETONATION

Whenever any friendly or enemy ground unit (BattleMech, ground vehicle or infantry) enters a minefield hex, the minefield automatically attacks the unit. The unit's player rolls 2D6. On a result of 7 or higher, the unit has hit a mine. Resolve the attack and apply the damage before the unit continues its movement. The defending player may make this roll secretly, so that if the minefield does not explode, its location remains hidden.

Minefields that explode inflict 1 point of damage to every element of every unit in the hex at the time of detonation. A minefield remains active and can make any number of attacks throughout the game, unless cleared (see **Clearing Minefields**, below).

## CLEARING MINEFIELDS

Clearing minefields is a dangerous job that requires great skill and finesse, and so it is usually assigned to infantry. If an enemy infantry unit ends its turn in a mined hex, the opposing player must be informed even if the field has not been detonated.

Infantry that spends one Movement Phase in a mined hex without moving may elect to clear the field instead of attacking during the Attack Phase. If the infantry unit rolls 2D6 with a result of 10 or higher in the Weapon Attack Phase, the unit has successfully cleared the field. A result of 5 or lower means that the minefield exploded, and the infantry takes normal damage. The minefield remains active after an accidental detonation. If multiple infantry units are attempting to clear the same hex, all must make successful rolls to clear the minefield. If any unit rolls a 5 or lower, all units attempting to clear the hex take damage.

Engineering vehicles (marked "eng" on the record sheet) can also clear minefields in the same way that infantry can, except that the vehicle successfully clears the field on a result of 8 or higher.

Players may also clear a minefield using artillery fire. The player must designate the fire mission as intended to clear the field. If the attack hits the mined hex, the player rolls 2D6. On a result of 5 or better, the strike clears the minefield. Artillery fire also does normal damage to units occupying the mined hex. Mines cleared in this way do no damage.

## MORALE

It takes considerable bravery to stand and fight in the face of deadly danger. The fact that soldiers enter the battlefield at all is a testament to their courage. However, in particularly shocking circumstances even a hardened combat unit may break under pressure, either freezing in place or, in extreme cases, literally fleeing the field of battle. The following morale rules are intended to simulate this aspect of war.

Using these rules significantly slows down game play. However, if both players agree, the increased realism can add a rewarding dimension to a **BattleForce** game.

## MORALE CHECKS

A unit must make a morale check at the end of any phase in which one or more of its elements was destroyed. The Base Target Number for this 2D6 roll is 8, modified by double the best skill modifier of any surviving element in the unit. For example, a skill modifier of -1 lowers the target number by 2; a skill modifier of -2 lowers the target number by 4. Infantry units apply an additional +1 to the target number; BattleMech units apply an additional -1 modifier.

If the result of the roll is greater than or equal to the modified target number, the unit passes its morale check. If the result is lower than the target number, the unit's morale is broken.

## BROKEN MORALE

A unit with broken morale cannot move closer than it already is to enemy units. In certain circumstances, this restriction may make the broken unit unable to move at all. However, if attacked, the elements of a broken unit still have their full MP for purposes of calculating to-hit numbers.

A broken unit cannot use or pass along commands. It can make attacks of its own, but cannot spot for other units' indirect-fire or artillery attacks.

If a broken unit must make additional morale checks, apply an additional +1 modifier to the target number. If a broken unit fails a morale check, it is routed, meaning that it is demoralized by panic. Such a unit must move away from enemy units as fast as it can in as straight a line as possible. If the scenario designates a home edge for the unit or an edge through which it can retreat, the routed unit moves directly toward that edge. A routed unit may not attack or take any action except to run away from the enemy.

# BATTLEFORCE



## RECOVERING NERVE

A broken unit may attempt to recover its nerve during the End Phase of each turn after the turn in which it broke. Such a unit will always spend at least one turn broken before it can recover. In order to recover its nerve, a broken unit must make a morale

check against the base target number modified by the skill modifier only. If the roll is successful, the unit recovers its nerve and may function normally. If it fails, the unit remains broken.

A routed unit is too far gone to recover its nerve. It will flee from the enemy until it leaves the map or is destroyed.

## CREATING SCENARIOS

The following guidelines will help you create original **BattleForce** scenarios using dice rolls and the element point values found in the **BattleForce Roster**, p. 118. Players also may simply set their own scenario parameters, rather than generating them with the dice-roll tables supplied in the following pages. Ultimately, the players should work together to come up with a scenario that is fun to play and fairly balanced. The following material will help you do that. Feel free to modify the tables to suit your playing style and needs.

### GENERAL RULES

General rules for setup, deployment and using objectives and headquarters appear in **Playing the Game**, p. 18. Unless otherwise noted in the specific rules for each scenario type, those and the following rules apply to all **BattleForce** scenarios created with this system.

### NUMBER OF PLAYERS

The mission-generation rules are written for two-player scenarios. If more than two individuals are playing, simply divide all the players into two opposing teams.

Games involving three or more sides can be played, but they tend to get complicated. Players can use these guidelines to create scenarios for more than two sides, but the application of these rules to such games is up to the players.

### MOVEMENT AND RETREAT

Scenario maps are fixed once play begins. No new maps may be added to the play area during the game. Unless otherwise noted, units that exit the map at any edge other than their home edge are considered destroyed. Units that exit the map through their home edge have retreated—they remain out of play for the remainder of the scenario and cannot return, but do not count as destroyed units when determining victory.

Half-hexes along the edge of the map—even those with hex numbers in them—are not considered part of the playing area. A unit that enters one of these half-hexes for any reason has exited the map.

If the players are using the off-board units rules (**Special Case Rules**, p. 37), those rules take precedence with regard to exiting the map.

### ENDING THE GAME

Generally, a scenario ends when all of one player's units have been destroyed or have retreated off the map. At that point, the opposing player wins. Depending on the specific scenario type, however, a player may need to achieve additional or alternative goals to claim victory.

### DETERMINING VICTORY

Victory in each scenario goes to the side that survives at the end, or to the side that fulfills specific victory conditions. Most scenarios include different levels of victory as well: Decisive, Substantial or Marginal. A player may win a Decisive, Substantial or Marginal victory depending on how well he meets the victory conditions.

The point system provides an alternate method of determining who wins and the level of victory achieved. Both players start with no Victory Points. For every enemy element destroyed, the player adds twice its point value to his point total (including points for the pilot, if any). For each of his own elements destroyed, the player deducts the point value of the element (plus the pilot) from his total.

At the end of the scenario, the player with the most points wins. If the difference between the two players' scores is greater than the number of points used to purchase forces for the winning side, the victory is Decisive. Otherwise, the victory is Marginal. If both players' scores are tied, the game is considered a Draw. For a list of pre-calculated point values for all **BattleForce** units, see the **BattleForce Roster**, p. 118.

Depending on the specific scenario being played, the victory levels may be determined in various ways. Players can also score victory points by claiming objectives or headquarters in a scenario (see **Types of Scenarios**, following). In most scenarios, the point value of occupying an objective is equal to the number of units with which your opponent started the game. Claiming an objective is worth five times as many points as occupying it. Headquarters (if used) are worth double the points of standard objectives.

## TYPES OF SCENARIOS

If desired, one player may randomly generate a scenario type by rolling 1D6 and consulting the Scenario Type Table. Alternatively, players may simply select a scenario type. The general types described below represent only a few of the possible scenarios that **BattleForce** players can create. Players can use these as models to create their own scenarios.

The following paragraphs contain brief descriptions of each type of scenario. Each description includes the special rules used to play that type of scenario, along with guidelines for force composition, the use of objectives, and victory conditions.

### SCENARIO TYPE TABLE

1D6	Scenario Type
1	Stand-up Fight
2	Hide and Seek
3	Hold the Line
4	Extraction
5	Break Through
6	The Chase

### STAND-UP FIGHT

In a stand-up fight, the simplest and most common type of scenario, two forces of roughly equal size square off against each other. Only one side will leave the field alive.

### Force Composition

Both sides should have the same number of units. Each side should also have an equal number of points. An appropriate point total for each side in a battalion-sized battle is 400 to 500 points.

# BATTLEFORCE

## Objectives

Objective counters are placed as described in the general rules, though for this type of scenario neither side places a headquarters counter on the map.

## Victory Conditions

The scenario ends when all the units on one side have been destroyed or have retreated off the map. The surviving side at the end of the scenario wins. The standard victory points and victory levels described in **Determining Victory** apply (p. 52).

## HIDE AND SEEK

This type of scenario requires players to use the rules for **Hidden Units** (p. 46) and **Minifields** (p. 49).

In a hide-and-peek scenario, one player is the attacker and the other is the defender. The defending player is "it"—his forces hide and the attacker attempts to find and destroy them.

Use half the number of mapsheets (rounded up) recommended in the Terrain rules (p. 54). If possible, avoid using the Large Lakes or Lake Area mapsheets. Urban mapsheets are ideal if buildings are used. Otherwise, avoid these mapsheets as well because they provide few hiding places for the defender's units.

After the attacking player selects a home map edge, the defending player sets up his units using the hidden units rules. The defending units may be placed on any hex anywhere on the map, except for Clear and Paved hexes. Additionally, the defending player may set minifields—one single-hex minifield for each unit in his force. For example, if the defender's force consists of a company of three lances, he can set three minifields.

## Force Composition

Set the attacking force at twice the size of the defending force. For example, if the defending player controls a company of three lances, the attacking player uses six lances. Players may use any size forces they wish, as long as the attacker's force is twice the size of the defender's. The point value of the attacking force should also be double that of the defending force.

## Objectives

Objective counters are not used in a hide-and-peek scenario.

## Victory Conditions

The scenario ends when all of one player's units have been destroyed or have retreated off the map. The player whose forces control the map or simply survive at the end wins the scenario. The standard point values and levels for victory apply, except that the defender gains 10 bonus points for each enemy unit destroyed. This bonus helps to offset the attacker's numerical advantage.

## HOLD THE LINE

In a hold-the-line scenario, the defending player must fend off a larger attacking force. The defending units may not intentionally leave the map for any reason.

## Force Composition

Set the attacking player's force at twice the size of the defender's force. For example, if the defending player controls a company of three lances, the attacking player may use six lances. Players may use any size forces they wish, as long as

the attacker's force is twice the size of the defender's. Set the experience levels of the defending player's forces at one level higher than those of the attacker's forces. For example, if the attacking force consists of Regular units (+0), the defender uses Veteran units (-1).

The point value of the defending force should equal that of the attacking force, though the defending force must be only half as large as the attacking force. This means the attacking force will consist of a large number of less powerful units.

## Objectives

Place objectives per the standard setup rules, except that only the defending player places a headquarters counter. The attacking player does not have a headquarters. As long as the defender's headquarters is not in enemy hands, it functions as a headquarters element (see **Special Equipment and Abilities**, p. 36).

## Victory Conditions

The scenario ends when all the units on one side have been destroyed or have retreated off the map.

If the defender destroys a number of opposing units equal to or greater than the number of defending units that started the scenario, the defending player wins. For example, if the defending player begins with three units, he can claim victory if he manages to destroy three or more attacking units. In all other cases, the player whose forces survive or control the map at the scenario's end wins.

If players wish to determine victory using the point system, standard rules for determining victory apply.

## EXTRACTION

In an extraction scenario, the attacking player attempts to extract a target, such as a secret weapon, an important diplomat or a computer memory core, from behind the defender's lines.

After the players place objective and headquarters counters, the attacker secretly chooses one of his objectives or the enemy headquarters as the target of the extraction. The attacker then writes down the target counter's number on a slip of paper, which he folds and gives to a neutral party for safekeeping (or the defending player can simply put the paper in his pocket without looking at it).

The attacking player may reveal the target to the defender during the End Phase of any turn. Any attacking unit can pick up the extraction target by occupying the target's hex during an End Phase. Additionally, a unit that retrieves the target can pass it to any friendly unit in the same hex or an adjacent hex during any End Phase.

If a unit carrying the extraction target is destroyed, place the objective counter representing the target in the hex previously occupied by the unit. Any unit in play can retrieve the target by occupying the target hex during any End Phase.

## Force Composition

Both sides start with an equal number of units and an equal number of points.

## Objectives

The attacker does not place a headquarters counter on the map. Otherwise, objectives are placed per standard rules.

# BATTLEFORCE

As described above, the attacking player secretly designates one of his objectives or the defender's headquarters as the extraction target before the game begins. Rather than being occupied and claimed like other objectives, that objective is treated as described above.

## Victory Conditions

If the attacker moves a unit carrying the extraction target off his home map edge, he wins the scenario. Otherwise, the defender wins.

When using the victory point system, victory is determined as follows. The defender scores points normally. However, the attacker scores only the straight point value for each opposing 'Mech he destroys (instead of twice the point value, as normal). The attacker loses points normally for each of his 'Mechs that the defender destroys. If the attacking player manages to get the extraction target off his home map edge, he scores points equal to the total points used to buy forces for his side in the scenario. The enemy headquarters is not worth double points in this type of scenario.

## BREAK THROUGH

In a break-through scenario, the attacking player's forces have become trapped behind enemy lines. To reach safety, the units must cross the map and break through the defender's forces.

Use one more mapsheet than the standard number recommended by the Terrain rules. If you have fewer than the needed number of mapsheets, simply use all available mapsheets. Place the mapsheets in a single, long row with their short edges touching.

Next, both players roll 2D6. The player who achieves the higher result may choose to play the defender or the attacker. The attacker then chooses one of the narrow edges of the map as the place from which his forces will enter. The attacker's home edge is the one opposite the entry edge. (The attacker's objective is to exit his forces at his home map edge.)

The defender may set up his forces in any hexes on the map. Additionally, he may position up to half of his units (round down) using the Hidden Units rules (p. 46).

## Force Composition

Both sides should have the same number of units and the same number of points.

## Objectives

Objective counters are not used in this type of scenario.

## Victory Conditions

The scenario ends when all the defending units have been destroyed or have retreated off the map, or when all attacking units have retreated or been destroyed. Attacking units may intentionally exit the map only at their home edge; a unit exiting from any other edge has retreated.

If all the attacking units survive and exit at their home edge, the attacking player wins a Decisive victory. If all the attacking forces are destroyed, or none exit at their home edge, the defending player wins a Decisive victory.

If players are using the point system to determine victory, victory points are allocated somewhat differently than usual. The defender scores points normally. The attacker scores the straight point value for destroying opposing 'Mechs rather than twice their point value. He also scores the straight point value for each attacking unit that exits the map via the attacker's home map edge. The attacker loses points normally for any of his own 'Mechs that the defender destroys. Determine the level of victory per standard rules, based on each side's final score.

## THE CHASE

In a chase scenario, the attacker's forces must race across the map to reach their DropShips before a larger force of pursuing defenders can reach them. Chase scenarios use the same rules as break-through scenarios, with the following exceptions.

The defending player does not deploy his forces until Turn 2. During Turn 1, attacking units may enter and move unopposed per standard rules. The defending units enter during the Movement Phase of Turn 2, from the same map edge as the attacking units.

## Force Composition

Set the defender's force at twice the size of the attacking force. The defending side should be worth twice the point value of the attacker's force.

## TERRAIN

An important part of any scenario is the terrain in which the battle will take place. Terrain is determined by the mapsheets used in the scenario. To choose your mapsheets, follow the steps given below.

## NUMBER OF MAPSHEETS

Before selecting mapsheets, determine how many you want to use. For most **BattleForce** games, one mapsheet for every ten units works best. For example, a scenario that pits a battalion of attackers against a battalion of defenders (twenty units in all) will work best with two mapsheets. A scenario that pits a regiment of attackers against a regiment of defenders (sixty units in all) will work best with six mapsheets. Other mapsheet/unit ratios that may be recommended for different types of scenarios appear in the scenario type descriptions.

## CHOOSING AND PLACING MAPSHEETS

This step obviously depends on how many different mapsheets the players have available. The **BattleForce 2** boxed set contains two copies of the basic **BattleForce** map; if you are playing only with this boxed set, you must use one or both of these mapsheets. If you have **BattleTech** or **CityTech** maps or any of the various **BattleTech** map sets on hand, you may choose from among those mapsheets as well.

If many different mapsheets are available to you, you may have one player choose the mapsheets and set them up. The other player then gets to choose his side's home map edge first.

Alternatively, you can pile all of your available mapsheets in a stack and shuffle them. Then roll 2D6 and count down from the top of the stack until you reach the number you rolled. Do this for each mapsheet needed for your game. If you have counted all the way through the whole stack, continue counting from the top until you have chosen your maps.

# BATTLEFORCE

To begin laying out the mapsheets, roll 2D6. The player with the higher result places the first selected mapsheet on the playing area. The other player then places the next selected mapsheet. The players take turns laying out the remaining mapsheets.

Each mapsheet must be placed with one of its short edges touching the short edge of a mapsheet already placed, or with one of its long edges touching the long edge of a mapsheet already placed. In addition, the mapsheets must form a single, continuous rectangular or square playing area. Within these and any other guidelines provided in the scenario type description, players may arrange the mapsheets as they see fit. If you are playing a scenario that uses buildings, always finish laying out the mapsheets before placing buildings on them (see **Buildings**, below).

## BUILDINGS

With the addition of buildings (see p. 43), players can play battles in the close quarters of an urban jungle. Deciding how many and what type of buildings to place is similar to selecting mapsheets.

Punch out all available building counters and place them in a mug or box top. Then take turns drawing and placing buildings in any hexes you like. As a rule of thumb, place 1D6 buildings per mapsheet. For densely populated urban areas, you may place 2D6 or even 3D6 buildings per mapsheet. Though buildings are not normally placed on mapsheets that lack roads or Paved hexes, you may place a few buildings on such maps if you wish.

If one player has chosen and set up the maps, the other player should place the buildings wherever he wishes. In extraction, hide-and-seek and break-through scenarios, the defending player should place the buildings because the battle is being fought on his home turf.

### Sample Map Layouts

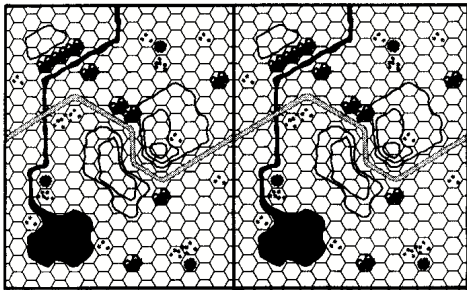

**NO**

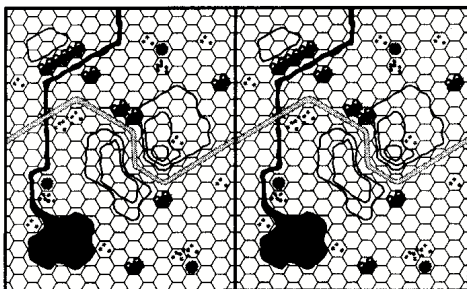
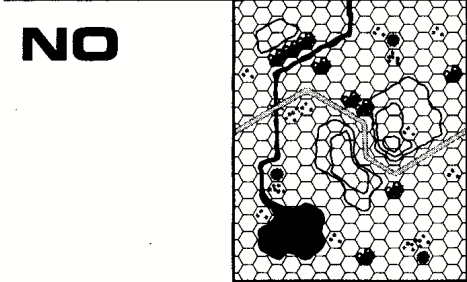

**YES**

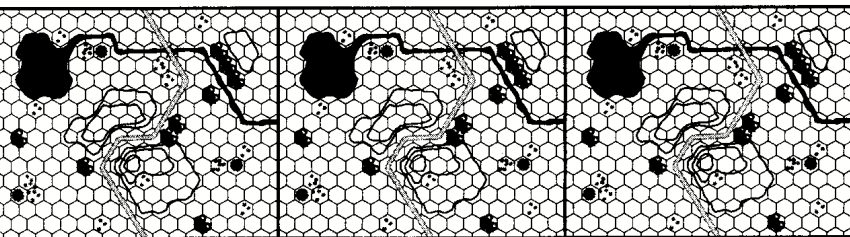

**YES**

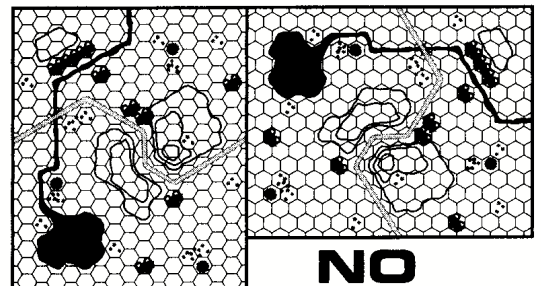

**NO**

## UNIT GENERATION

After selecting the scenario type and mapsheets, players choose the units that will take part in the scenario. Players can generate their fighting forces through random dice rolls or by using the point system. When using dice rolls, players first determine their forces' composition, then assign BattleMechs, and finally set the Experience levels of their units. This system may not always produce evenly matched forces; however, players may increase the likelihood of generating balanced forces by first setting a specific weight class, equipment rating and Experience level for both sides.

The point system (see **Point System**, p. 62) tends to create more balanced forces, but it is not perfect. Players must exercise their judgment when using the point system to ensure that their games are fair and enjoyable.

## RANDOM DICE ROLLS

In most scenarios, the forces on each side are equal. For example, each side might consist of four Veteran heavy lances or of two Elite light lances and two Regular medium lances. If both players agree, they can randomly determine the composition of each side using the weight class and composition tables below.

In general, forces created by random dice rolls will be roughly equal, but only if both sides are Inner Sphere or Clan. Battles pitting Clan against Inner Sphere units may be severely unequal because Clan 'Mechs and MechWarriors are considerably superior to their Inner Sphere counterparts. Players can address this problem by giving the Inner Sphere side a two-to-one numerical advantage over the Clan side; the Clan player should have half as many 'Mechs as the scenario normally requires. Enforcing the Clan honor rules (see p. 45) will also even the score somewhat.

The tables below provide weight classes and compositions for standard Inner Sphere and Clan forces. For ComStar forces (which operate in formations of six), use the Inner Sphere tables and add one additional unit or element of the heaviest and lightest weight classes in the particular formation. For example, a Company Type roll result of 3 on the Random Weight Class Table normally results in 1 Light, 1 Medium and 1 Heavy lance.



## RANDOM WEIGHT-CLASS TABLE

### Unit Type

1D6 Result	Unit Type
1-4	Conventional
5-6	BattleMech

### Lance or Star Type

2D6 Result	Lance Weight Class	Star Weight Class
2	Light	Elemental
3-6	Light	Light
7-8	Medium	Medium
9-10	Heavy	Heavy
11	Assault	Assault
12	Assault	Nova (Roll again for weight class)

### Company Type

1D6 Result	Lance Weight Classes
1	3 Light
2	2 Light, 1 Heavy
3	1 Light, 1 Medium, 1 Heavy
4	1 Light, 1 Heavy, 1 Assault
5	1 Medium, 1 Heavy, 1 Assault
6	2 Heavy, 1 Assault

### Binary/Trinary Type

1D6 Result	Star Weight Classes (Binary)	Star Weight Classes (Trinary)
1	2 Light	3 Light
2	1 Light, 1 Medium	2 Light, 1 Heavy
3	2 Medium	1 Light, 1 Medium, 1 Heavy
4	1 Medium, 2 Heavy	1 Light, 1 Heavy, 1 Assault
5	2 Heavy	1 Medium, 1 Heavy, 1 Assault
6	1 Heavy, 1 Assault	2 Heavy, 1 Assault

A ComStar formation would add an additional Light and an additional Heavy lance to this makeup.

### Force Composition

Begin assembling forces by determining the size of each force. Often, the specific conditions of a scenario suggest a particular size. Players may wish to consider available playing time as well—larger engagements may take considerably longer to complete than smaller ones.

After determining the size of each force, determine its weight class. For lance- or Star-sized forces, roll 2D6 and consult the Lance or Star Type section of the Random Weight-Class Table. For company-, Binary- or Trinary-sized forces, roll 1D6 and consult the appropriate section of the table. If a company-sized force contains more than three lances, use the Lance or Star Type section to determine the weight class of the extra lances.

In an Inner Sphere force, some or all of the units may consist of conventional forces (vehicles and infantry) as opposed to BattleMechs. This choice is normally left up to the players, though each unit's type in this regard can also be randomly

generated with the Unit Type table. Keep in mind that using the Unit Type Table will likely result in a high proportion of vehicle units, as vehicles are far more common than BattleMechs in Inner Sphere armies. Clan units consist of 'Mechs and battle armor unless a scenario specifically calls for other types of forces or players are using the point system.

After determining the weight classes of the lance(s) or Star(s) in each force, use the Lance/Star Composition Table to determine the weight classes of the elements in each lance or Star.

### Assigning Elements

After determining the weight classes of the elements in each force, use the Random 'Mech Assignment, Random Vehicle Assignment and Random Aerospace Fighter Assignment tables to determine the specific elements in each unit.

To use the random assignment tables, roll 2D6 and cross-reference the result with the appropriate weight class of 'Mech, vehicle or fighter.

Though players can use the random assignment tables to determine the composition of any force, the tables are simplified and only use a fraction of the forces available in the game. To create forces using a wider range of 'Mechs, players may use the Random 'Mech Assignment Table from the appropriate **BattleTech Field Manual**, or use the point system to choose any forces they like (see p. 62).

## LANCE/STAR COMPOSITION TABLE

### Light Lance/Star

1D6 Result	Lance Element Weight Classes	Star Element Weight Classes
1	4 Light	5 Light
2-3	3 Light, 1 Medium	4 Light, 1 Medium
4-5	2 Light, 2 Medium	3 Light, 2 Medium
6	2 Light, 1 Medium, 1 Heavy	2 Light, 2 Medium, 1 Heavy

### Medium Lance/Star

1D6 Result	Element Weight Classes	Element Weight Classes
1	1 Light, 3 Medium	1 Light, 4 Medium
2-3	1 Light, 2 Medium, 1 Heavy	5 Medium
4-5	4 Medium	4 Medium, 1 Heavy
6	3 Medium, 1 Heavy	3 Medium, 2 Heavy

### Heavy Lance/Star

1D6 Result	Element Weight Classes	Element Weight Classes
1	2 Medium, 2 Heavy	2 Medium, 3 Heavy
2-3	1 Medium, 3 Heavy	1 Medium, 4 Heavy
4-5	4 Heavy	5 Heavy
6	1 Medium, 2 Heavy, 1 Assault	1 Medium, 3 Heavy, 1 Assault

### Assault Lance/Star

1D6 Result	Element Weight Classes	Element Weight Classes
1	1 Medium, 1 Heavy, 2 Assault	1 Medium, 2 Heavy, 2 Assault
2-3	3 Heavy, 1 Assault	4 Heavy, 1 Assault
4-5	2 Heavy, 2 Assault	3 Heavy, 2 Assault
6	1 Heavy, 3 Assault	2 Heavy, 3 Assault

# BATTLEFORCE

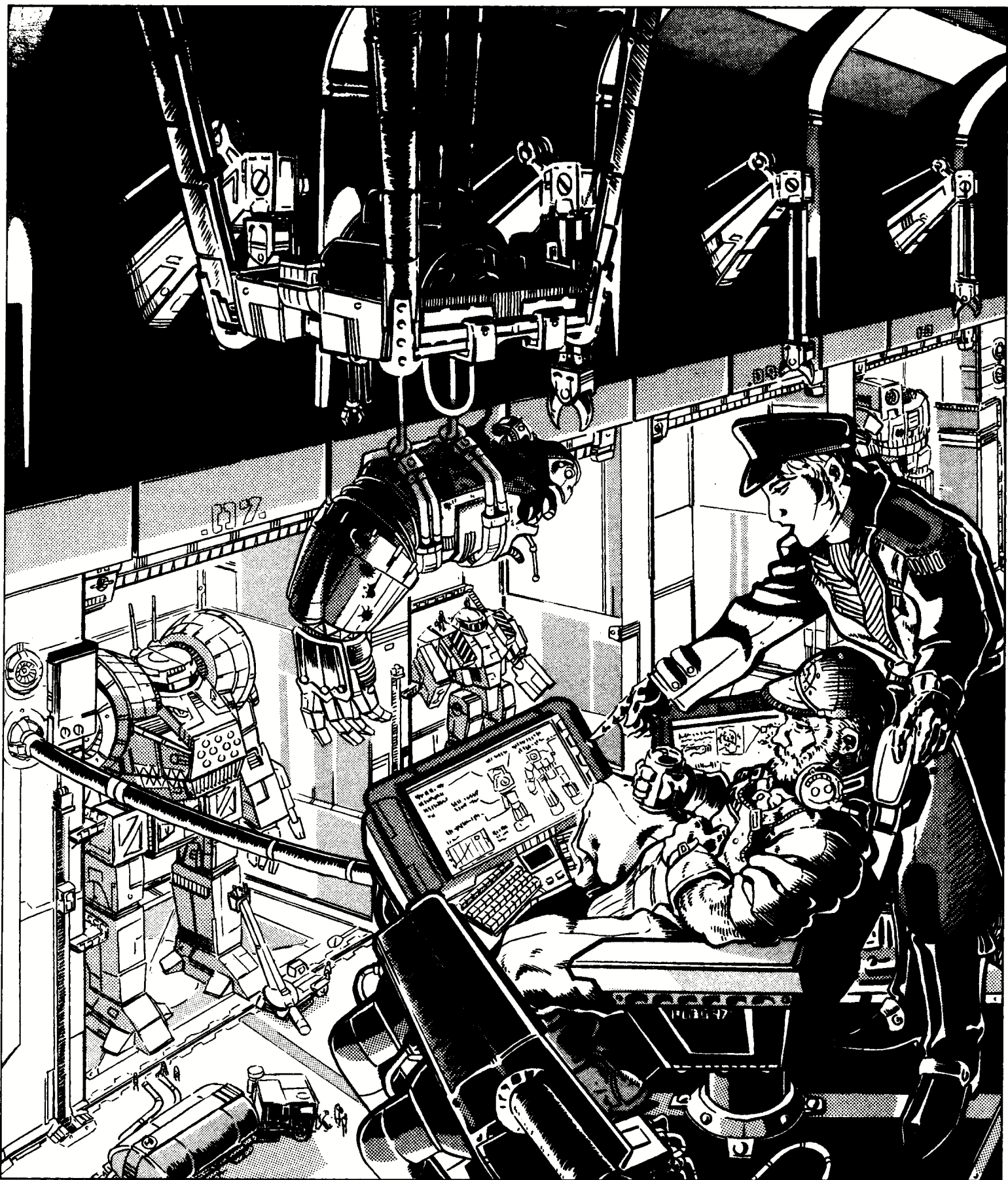

# BATTLEFORCE

## RANDOM 'MECH ASSIGNMENT TABLE: INNER SPHERE

### Light 'Mechs

2D6	House Kurita	House Liao	House Marik
2	HM-1 Hitman	JA-KL-1532 Jackal	ZPH-1A Tarantula
3	JR7-D Jenner	JR7-D Jenner	ZPH-1A Tarantula
4	OW-1 Owens	RVN-3L Raven	JA-KL-1532 Jackal
5	PNT-10K Panther	UM-R63 UrbanMech	HER-3S Hermes
6	RTX1-OC Raptor	FS9-S Firestarter	SDR-7M Spider
7	RTX1-O Raptor	RVN-3L Raven	HMR-3M Hammer
8	PNT-10K Panther	SDR-5V Spider	HMR-3M Hammer
9	JR7-K Jenner	UM-R63 UrbanMech	JR7-D Jenner
10	SDR-7M Spider	ZPH-1A Tarantula	HER-3S Hermes
11	SDR-9K Venom	JVN-10N Javelin	FNHK-9K Falcon Hawk
12	PNT-9R Panther	UM-R60 UrbanMech	ZPH-1A Tarantula

### Medium 'Mechs

2D6	House Kurita	House Liao	House Marik
2	KTO-20 Kintaro	BJ2-OE Blackjack	FS9-OF Firestarter
3	WFT-1 Wolf Trap	SNK-1V Snake	APL-1M Apollo
4	DMO-1K Daimyo	HUR-WO-R4L Huron Warrior	CDA-3M Cicada
5	SR1-O Strider	VND-3L Vindicator	HER-2S Hermes II
6	BJ2-O Blackjack	DV-7D Dervish	TBT-7M Trebuchet
7	FS9-O Firestarter	VND-3L Vindicator	HER-5S Hermes II
8	SR1-OD Strider	BJ-2 Blackjack	HBK-5M Hunchback
9	KIM-2 Komodo	CLNT-2-3U Clint	HER-5S Hermes II
10	WFT-1 Wolf Trap	SNK-1V Snake	TBT-7M Trebuchet
11	BJ2-OA Blackjack	HUR-WO-R4L Huron Warrior	TR1 Wraith
12	LNK-9C Lynx	BJ2-OE Blackjack	BJ2-OE Blackjack

### Heavy 'Mechs

2D6	House Kurita	House Liao	House Marik
2	DGR-3F Dragon Fire	THR-1L Thunder	ANV-3M Anvil
3	AV1-OA Avatar	ON1-K Orion	WR-DG-02-FC War Dog
4	DRG-5K Grand Dragon	CPLT-C1 Catapult	GLT-5M Guillotine
5	BHKU-O Black Hawk-KU	CTF-3L Cataphract	TMP-3M Tempest
6	DAI-01 Daikyu	CPLT-C3 Catapult	ON1-M Orion
7	DRG-5K Grand Dragon	CTF-3L Cataphract	ON1-M Orion
8	QKD-5K Quickdraw	GHR-5J Grasshopper	CPLT-C1 Catapult
9	CPLT-K2 Catapult	CPLT-C3 Catapult	GLT-5M Guillotine
10	MTR-5K Maelstrom	ANV-3M Anvil	TMP-3M Tempest
11	AV1-O Avatar	GHR-5H Grasshopper	HRC-LS-9000 Hercules
12	NDA-1K No Dachi	WR-DG-02FC War Dog	P1 Perseus

### Assault 'Mechs

2D6	House Kurita	House Liao	House Marik
2	OBK-M10 O-Bakemono	STC-2D Striker	ALB-3U Albatross
3	NG-C3A Naginata	AWS-9M Awesome	CGR-1A1 Charger
4	HTM-27T Hatamoto-Chi	MR-V2 Cerberus	T-IT-N10M Grand Titan
5	SD1-O Sunder	AS7-K Atlas	STK-5M Stalker
6	AS7-K Atlas	EMP-6A Emperor	AS7-D Atlas
7	HTM-27T Hatamoto-Chi	STK-3F Stalker	AWS-9M Awesome
8	MAL-1R Mauler	STK-5M Stalker	AWS-9M Awesome
9	CRK 5003-2 Katana	As7-K Atlas	AS7-K Atlas
10	CGR-3K Charger	AWS-8Q Awesome	MR-V2 Cerberus
11	SD1-OB Sunder	CP-11-A Cyclops	LGB-7Q Longbow
12	AKU-1X Akuma	T-IT-N10M Grand Titan	GRN-D-01 Grand Crusader

# BATTLEFORCE

## RANDOM 'MECH ASSIGNMENT TABLE: INNER SPHERE

### Light 'Mechs

2D6	House Davion	House Steiner	ComStar
2	RTX1-O Raptor	NTK-2Q Night Hawk	HSR-400-D Hussar
3	HNT-171 Hornet	WLF-2 Wolfhound	UM-R63 UrbanMech
4	ALM-7D Fireball	BZK-F3 Hollander	THE-N Thorn
5	JVN-10P Javelin	SDR-5V Spider	MON-66 Mongoose
6	WLF-2 Wolfhound	COM-5S Commando	MCY-99 Mercury
7	JVN-10P Javelin	FS9-S Firestarter	MCY-99 Mercury
8	COM-5S Commando	COM-5S Commando	HER-1S Hermes
9	JR7-D Jenner	JVN-10P Javelin	THE-N Thorn
10	DRT-3S Dart	JR7-D Jenner	HSR-200-D Hussar
11	BH-305 Battle Hawk	COM-2D Commando	MON-66 Mongoose
12	SPR-5F Spector	TLN-5W Talon	NXS1-A Nexus

### Medium 'Mechs

2D6	House Davion	House Steiner	ComStar
2	FS9-O Firestarter	END-6Q Enfield	WVE-9N Wyvern
3	ASN-23 Assassin	ENF-5D Enforcer	CLT-2-3U Clint
4	STH-1D Stealth	HCT-5S Hatchetman	STN-3L Sentinel
5	BJ-2 Blackjack	CLNT-2-3U Clint	GRM-R-PR29 Grim Reaper
6	WTH-2 Whitworth	VL-5S Vulcan	CRB-27 Crab
7	ENF-5D Enforcer	HCT-3F Hatchetman	CRB-27 Crab
8	HCT-5S Hatchetman	NGS-4S Nightsky	WVE-5N Wyvern
9	CN9-D Centurion	VL-5S Vulcan	HBK-5N Hunchback
10	NGS-4S Nightsky	CN9-D Centurion	ASN-23 Assassin
11	ENF-5D Enforcer	BSW-X1 Bushwacker	KTO-19 Kintaro
12	SR1-O Strider	STY-3C Starslayer	RJN101-A Raijin

### Heavy 'Mechs

2D6	House Davion	House Steiner	ComStar
2	FLC-8R Falconer	CTS-6Y Cestus	BL-9-KNT Black Knight
3	MDG-1A Rakshasa	GHR-5J Grasshopper	CHP-3N Champion
4	AXM-1N Axman	CES-3R Caesar	BMB-12D Bombardier
5	BNDR-01A Bandersnatch	GAL-1GLS Gallowglas	BL-6-KNT Black Knight
6	CES-3R Caesar	PTR-4D Penetrator	LNC25-01 Lancelot
7	JM6-DD JagerMech	CES-3R Caesar	GLT-3N Guillotine
8	FLC-8R Falconer	WR-DG-02FC War Dog	FLS-8K Flashman
9	JM6-DD JagerMech	AXM-1N Axman	CHP-1N Champion
10	MDG-1A Rakshasa	GAL-1GLS Gallowglas	EXT-4D Exterminator
11	CTF-3D Cataphract	MTR-5K Maelstrom	ST-8A Shootist
12	PTR-4D Penetrator	DGR-3F Dragon Fire	EXC-B2 Excalibur

### Assault 'Mechs

2D6	House Davion	House Steiner	ComStar
2	DVS-2 Devastator	STC-2C Striker	KGC-001 King Crab
3	CP-11-A Cyclops	STK-5S Stalker	STK-5M Stalker
4	GUN-1ERD Gunslinger	PPR-5S Salamander	CRK-5003-1 Crockett
5	AWS-8Q Awesome	STK-3F Stalker	THG-11E Thug
6	VTR-9K Victor	ZEU-9S Zeus	HGN-732 Highlander
7	VTR-9K Victor	ZEU-9S Zeus	HGN-732 Highlander
8	AS7-S Atlas	BNC-5S Banshee	CRK-5003-1 Crockett
9	VTR-9B Victor	AS7-S Atlas	AS7-K Atlas
10	AS7-K Atlas	BRZ-A3 Berserker	KGC-000 King Crab
11	BNC-5S Banshee	ZEU-6S Zeus	CP-11-A Cyclops
12	LGB-7Q Longbow	EMP-6A Emperor	SPT-N2 Spartan

# BATTLEFORCE

## RANDOM 'MECH ASSIGNMENT TABLE: CLANS

### Light 'Mechs

2D6	Jade Falcon	Wolf	Ghost Bear	Smoke Jaguar
2	Vixen	Jenner IIC	Jenner IIC	Peregrine
3	Fire Falcon Prime	Puma A	Dasher C	Koshi A
4	Cougar C	Koshi B	Dasher D	Puma Prime
5	Uller B	Puma B	Puma Prime	Hankyu Prime
6	Fire Falcon A	Dasher A	Dasher B	Koshi B
7	Uller Prime	Puma Prime	Dasher Prime	Hankyu A
8	Cougar Prime	Uller C	Puma A	Koshi Prime
9	Uller A	Puma C	Uller A	Hankyu C
10	Uller D	Puma D	Koshi B	Koshi C
11	Fire Falcon B	Koshi A	Dasher A	Dasher B
12	Baboon	Jenner IIC	Peregrine	Jenner IIC

### Medium 'Mechs

2D6	Jade Falcon	Wolf	Ghost Bear	Smoke Jaguar
2	Hellhound	Hunchback IIC	Black Hawk A	Hunchback IIC
3	Ryoken Prime	Fenris C	Ryoken Prime	Grendel A
4	Fenris A	Phantom Prime	Fenris Prime	Ryoken B
5	Dragonfly A	Fenris D	Dragonfly A	Grendel Prime
6	Black Lanner C	Phantom C	Black Hawk Prime	Black Hawk C
7	Black Lanner Prime	Fenris B	Dragonfly Prime	Ryoken Prime
8	Ryoken B	Fenris Prime	Dragonfly B	Ryoken A
9	Black Hawk A	Ryoken Prime	Ryoken C	Shadow Cat Prime
10	Black Lanner A	Pouncer Prime	Dragonfly D	Grendel D
11	Black Lanner B	Black Hawk Prime	Dragonfly C	Shadow Cat A
12	Hunchback IIC	Pouncer A	Hunchback IIC	Fenris Prime

### Heavy 'Mechs

2D6	Jade Falcon	Wolf	Ghost Bear	Smoke Jaguar
2	Night Gyr D	Linebacker Prime	Grizzly	Cauldron-Born Prime
3	Thor B	Mad Cat D	Loki Prime	Vulture C
4	Loki A	Vulture Prime	Vulture A	Thor Prime
5	Night Gyr Prime	Mad Cat B	Thor A	Mad Cat Prime
6	Thor A	Loki Prime	Mad Cat Prime	Vulture B
7	Loki Prime	Mad Cat Prime	Vulture Prime	Vulture Prime
8	Thor Prime	Mad Cat A	Vulture C	Loki A
9	Thor D	Thor Prime	Thor Prime	Vulture A
10	Night Gyr A	Mad Cat C	Vulture B	Mad Cat C
11	Loki B	Vulture A	Mad Cat A	Thor D
12	Night Gyr C	Galahad	Loki B	Cauldron-Born B

### Assault 'Mechs

2D6	Jade Falcon	Wolf	Ghost Bear	Smoke Jaguar
2	Kraken	Naga Prime	Supernova	Man O' War C
3	Turkina B	Man O' War B	Man O' War Prime	Daishi B
4	Gladiator C	Masakari A	Gladiator B	Kingfisher C
5	Masakari Prime	Gladiator D	Kingfisher Prime	Masakari C
6	Turkina A	Man O' War C	Daishi Prime	Kingfisher Prime
7	Turkina Prime	Man O' War Prime	Gladiator Prime	Masakari Prime
8	Daishi Prime	Gladiator Prime	Masakari B	Daishi Prime
9	Masakari B	Man O' War A	Gladiator A	Masakari A
10	Turkina C	Daishi Prime	Masakari Prime	Daishi A
11	Masakari A	Masakari Prime	Gladiator D	Kingfisher D
12	Man O' War A	Supernova	Kodiak	Behemoth

# BATTLEFORCE

## RANDOM VEHICLE ASSIGNMENT TABLE: INNER SPHERE

2D6	Light Vehicle	Medium Vehicle	Heavy Vehicle	Assault Vehicle
2	Yellow Jacket Gunship	Regulator Hovertank	Zhukov Heavy Tank	Alacorn Mk VI Heavy Tank
3	Striker Light Tank	Goblin Medium Tank	Patton Tank	SturmFeur Heavy Tank
4	Harasser Missile Platform	Hetzer Wheeled Assault Gun	Po Heavy Tank	Schrek PPC Carrier
5	Hunter Light Support Tank	Drillson Heavy Hover Tank	Manticore Heavy Tank	Partisan Heavy Tank
6	Saladin Assault Hover Tank	Maxim Heavy Hover Transport	Pike Support Vehicle	Demolisher Heavy Tank
7	Saracen Medium Hover Tank	Vedette Medium Tank	LRM Carrier	Ontos Heavy Tank
8	Scimitar Medium Hover Tank	Maxim Heavy Hover Transport	SRM Carrier	Ontos Heavy Tank
9	Pegasus Scout Hover Tank	Condor Heavy Hover Tank	Bulldog Medium Tank	Schrek PPC Carrier
10	Scorpion Light Tank	Goblin Medium Tank	Von Luckner Heavy Tank	Partisan Heavy Tank
11	J. Edgar Light Hover Tank	Drillson Heavy Hover Tank	Rommel Tank	Behemoth Heavy Tank
12	Cavalry Attack Helicopter	Fulcrum Heavy Hover Tank	Tokugawa Heavy Tank	Challenger X MBT

## RANDOM AEROSPACE FIGHTER ASSIGNMENT TABLE: INNER SPHERE

2D6	Light Aerospace Fighter	Medium Aerospace Fighter	Heavy Aerospace Fighter
2	TRN-3T Trident	IRN-SD1 Ironsides	HMR-HD Hammerhead
3	SL-21 Sholagar	LCF-R15 Lucifer	TR-13 Transgressor
4	TR-7 Thrush	F-90 Stingray	STU-K5 Stuka
5	F-10 Cheetah	CSR-V12 Corsair	F-100 Riever
6	TR-7 Thrush	TR-10 Transit	CHP-W5 Chippewa
7	SPR-H5 Sparrowhawk	F-90 Stingray	SL-15 Slayer
8	F-10 Cheetah	LCF-R15 Lucifer	TR-13 Transgressor
9	SL-21 Sholagar	CSR-V12 Corsair	STU-K5 Stuka
10	SYD-21 Seydlitz	SL-17 Shilone	CHP-W5 Chippewa
11	SPR-H5 Sparrowhawk	TR-10 Transit	SL-15 Slayer
12	SPD-502 Spad	GTHA-500 Gotha	RPR-100 Rapier

## RANDOM AEROSPACE FIGHTER ASSIGNMENT TABLE: CLAN

2D6	Light Aerospace Fighter	Medium Aerospace Fighter	Heavy Aerospace Fighter
2	Avar Prime	Turk C	Jengiz Prime
3	Vandal Prime	Turk A	Sabutai Prime
4	Bashkir A	Visigoth C	Scytha B
5	Batu Prime	Jagatai Prime	Scytha Prime
6	Sulla A	Visigoth A	Kirghiz B
7	Sulla Prime	Visigoth Prime	Kirghiz Prime
8	Sulla B	Visigoth B	Kirghiz A
9	Batu A	Jagatai B	Scytha A
10	Bashkir Prime	Visigoth C	Scytha C
11	Vandal B	Jagatai B	Sabutai A
12	Avar C	Turk Prime	Jengiz A

### Experience Level and Skills

After determining the elements in each force, the players must determine the Experience level and skill modifiers of their MechWarriors and vehicle crews. Infantry units are generally assumed to be Regular, though players can give them exceptional skills and experience if desired. If the players agree, they can simply choose an Experience level and assign all MechWarriors the standard skill modifiers for that level. Alternatively, each player may determine his MechWarriors' Experience and skill levels using the Random Experience Level and Random Skill Modifiers tables.

**BattleForce** elements have one of four Experience levels: Green, Regular, Veteran or Elite. Players can help ensure a balanced battle by setting the same Experience level for both

sides. To randomly determine Experience levels, roll 2D6 and consult the Random Experience Level Table.

### RANDOM EXPERIENCE LEVEL TABLE

2D6 Result	Experience Level
2-5	Green
6-9	Regular
10-11	Veteran
12	Elite

# BATTLEFORCE

To randomly determine skill modifiers, each player should roll 1D6 for each MechWarrior and vehicle crew in his force and then consult the Random Skill Modifiers Table. (Reduce the skill modifier by 1 for Clan MechWarriors if the Clan player agrees to follow the Clan rules of engagement; see **Clan Honor**, p. 45.)

## RANDOM SKILL MODIFIERS TABLE

1D6 (Green)	1D6 (Regular)	1D6 (Veteran)	1D6 (Elite)	Skill Modifier
1	—	—	—	+2
2-3	—	—	—	+1
4-5	1-2	—	—	+0
6	3-4	1-2	—	+0
—	5-6	3-4	1-2	-1
—	—	5-6	3-4	-2
—	—	—	5-6	-3

### Finishing Touches

If both players agree, they can "fine-tune" their units by shifting elements between units after they have generated all of their forces. Fine-tuning a force in this manner enables a player to group elements with similar movement capabilities in units together.

Each player must also designate company, battalion and regimental command units within their forces. Usually, the MechWarrior with the highest skills and/or heaviest BattleMech in each unit is the unit's commander, but players may use any criteria they wish. After selecting commanders, each player should identify command units as such on those units' record sheets.

### POINT SYSTEM

To help ensure more balanced forces, players may use the following point system in lieu of random dice rolls. If both sides in a battle are worth an equal number of points under this system, they should have equal chances of winning. Keep in mind, however, that such factors as player skill, terrain and so on can alter this balance.

Each BattleMech and vehicle has a point value listed in the **BattleForce Roster** (p. 118). The **BattleForce Rosters** include every published **BattleTech** unit at the time of the printing of this game. To generate point values for elements not on the list, simply take that element's Battle Value point rating and divide it by 100, using standard round-offs (round up for .5). If a particular element does not have a Battle Value, generate a Battle Value for it using the Battle Value system, which appears in the **Maximum Tech** advanced rulebook.

### Piloting/Driving and Gunnery Skills

Players can also use points to purchase better-trained MechWarriors, vehicle crews and infantry units. When using the point system, every element is assumed to have a Regular pilot

or crew unless points are spent to improve them. The cost is expressed as a multiple applied to the base point value of the element.

The Experience level can either directly determine the pilot's or crew's skills, as shown below, or players can determine skills by rolling on the Random Skill Modifiers Table based on the purchased Experience level. Both players must use the same method; if one player rolls randomly for skills, the other player must also. Players cannot purchase improved skills for infantry elements unless both sides agree to do so.

The skills of Clan pilots depend on whether or not the Clan rules of engagement are in effect (see **Clan Honor**, p. 44). If the Clan forces follow the rules of engagement, reduce their skill modifiers by 1. If they are not following the Clan rules of engagement, they receive standard skill modifiers based on their Experience levels.

Experience Level	Skill Modifier	Point Multiple
	+2	.7
Green	+1	.9
Regular	0	1
Veteran	-1	1.1
Elite	-2	1.3
	-3	1.6
	-4	2

Apply the Point Multiple for the desired skill level to the base point value of the element as shown in the **BattleForce Rosters** on p. 118. When calculating Victory Points and so on for scenarios, always use the point value as modified by the Point Multiple. Use normal rounding; players cannot reduce the cost of a unit below .5 after applying the Point Multiple.

### Bidding to Play the Clans

If both players want to play the Clan side in a scenario, they may invoke the Clan ritual of *batchall* to settle the dispute. In this case, the players bid to determine who gets the "honor" of playing the Clans.

First, choose the point level for the Inner Sphere side. Then both bidding players should roll 2D6. The player with the highest result starts the bidding, with any number of points up to the amount of points that the Clan side would normally get for the scenario. The other player then offers a counter bid that must be lower than the previous bid. The players take turns reducing the bid until one player is unwilling to make a lower bid.

The player who makes the lowest bid plays the Clans for the scenario and must purchase forces using the points he bid. The other player will play the Inner Sphere side.

### SETTING THE STAGE

War is a daily fact of life for most people in the Inner Sphere. Border disputes spark small conflicts that last days, weeks or even months; these die down to a simmer in short order but rarely end completely. Along the Successor States' borders with the Periphery, countless pirate bands roam the spaceways in search of loot and slaves. Raids by these merciless cutthroats are the most common type of warfare in the

# BATTLEFORCE

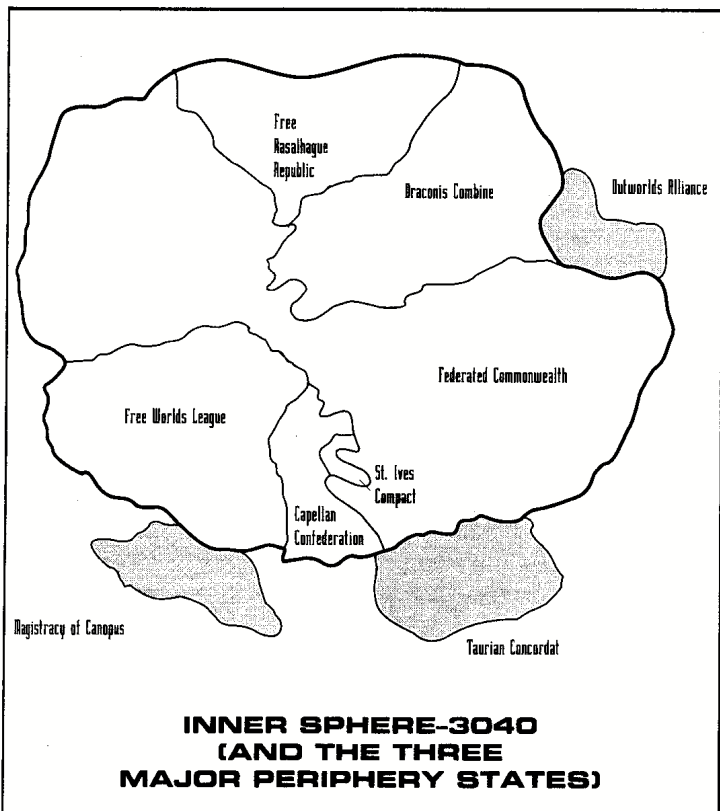

ing these wars, though they can certainly clash in scenarios outside of those conflicts. With the exception of the Clans, any side in a given conflict may have mercenary forces fighting along with it.

## BEFORE THE CLANS

Following are brief descriptions of the major wars that took place before the rediscovery of Star League-era technology and the coming of the Clans.

The map below represents the Inner Sphere prior to the Clan invasion and the recovery of Star League technology (c. 3040); it shows the political borders of that time. Each of the areas on the map contains hundreds of populated star systems. In general, only states that border one another may be involved in a conflict, except when they are acting as allies of other combatants.

## Fourth Succession War (3028-3030)

Hanse Davion's Operation Rat—a major assault on the Capellan Confederation—triggered this conflict, which swiftly engulfed the entire Inner Sphere after one hundred years of relative peace. The aggressor in this war was unquestionably the Federated Commonwealth, and so most scenarios should involve House Davion or Steiner forces as the attacker, with Capellan, Draconis Combine or Free Worlds League forces defending. Hanse Davion's brilliant strategic planning led to many of the war's greatest victories. To simulate this in game play, give the attacking Federated Commonwealth a degree of advantage at the beginning of the scenario. However, make sure the defenders have some counter-balancing factor in their favor. For example, the Federated Commonwealth player might gain +2 to all Initiative rolls, but the other player gets to choose the mapsheets and pick his own home edge.

**Attackers:** Federated Commonwealth

**Allies:** Federated Suns, Lyran Commonwealth

**Defenders:** Concord of Kapteyn

**Allies:** Capellan Confederation, Draconis Combine, Free Worlds League

## Andurien/Canopus Invasion (3030-3035)

This war represents one of the few times in history that a Successor State was seriously threatened by a less powerful neighboring realm. The Duchy of Andurien, which had recently seceded from the Free Worlds League, allied with its Periphery neighbor, the Magistracy of Canopus. In a bid for power, these two minor states joined forces in an attempt to topple the Capellan Confederation. Because the Capellans were still seriously weakened from the Fourth Succession War, the Andurien invasion actually looked as if it might succeed in its early stages. To represent the sad state of the Confederation when the invasion began, give each Capellan element 1 point of armor damage before the start of the game. To simulate the Capellan player's home-turf advantage, allow him to choose his home map edge; in addition, the Capellan side automatically wins the Initiative in the first game turn.

**Attackers:** Free Worlds League (Duchy of Andurien)

**Allies:** Magistracy of Canopus

**Defenders:** Capellan Confederation (no allies)

absence of major conflicts. Massive, multi-planet wars also occasionally break out in the Inner Sphere. The most famous of these are the Succession Wars, which continued almost without abatement from the collapse of the Star League in 2781 to the end of the Fourth Succession War in 3030.

Players can use these wars as settings for their **BattleForce** games, giving a background story to each scenario by setting it in a particular time and place with particular forces on each side. Though you need not choose a setting for your scenarios, doing so helps to set the tone and intensify the action. After all, wouldn't you fight that much harder to defend your home soil than you would for a mere mapsheet?

Some scenarios include special rules to help simulate a particular conflict. These rules are simply guidelines; you need not use them in your games, and they do not apply to the scenario types previously presented. Feel free to use the descriptions of past wars to invent your own special rules.

## Allied Forces

Each side in a war consists of one or more independent nations, much like the Axis and the Allies in World War II. These nations may be fighting a common foe, but more often than not they merely agree to a "non-aggression pact." In other words, allied forces will not attack each other, but may or may not fight alongside one another.

When creating a scenario set during one of **BattleTech's** historical wars, pick one force from each group of allies. The allies and their names are given in the description of each conflict. Forces listed as allies may not fight against each other dur-



# BATTLEFORCE

## The Ronin Wars (3034)

When the Free Rasalhague Republic declared its independence from the Draconis Combine, several Combine military units refused to follow their Kanrei's orders to leave their posts in Republic space. The wars that followed involved Kanrei Theodore Kurita's efforts to bring these rebellious troops, known as the Ronin, into line. Scenarios set in this brief but bitter war follow standard rules, with the following exception. In battles with Combine forces on both sides, neither side can retreat; both must fight to the last element. Either side may be the attacker or the defender.

**Side 1:** Rasalhague Kungsarmé (Free Rasalhague Republic)

**Allies:** Draconis Combine loyalists

**Side 2:** Ronin (no allies)

## Andurien War of Secession (3035-3040)

Intense political strife in the Free Worlds League allowed the rebellious Duchy of Andurien to remain separate from it for nearly five years—until Andurien agents were blamed for the bomb that assassinated the League's leader, Captain-General Janos Marik, in 3035. Duncan Marik immediately assumed the Captain-Generalcy and launched an ill-planned campaign against the Duchy of Andurien. In 3036, at about the same time that Janos's youngest son Thomas Marik returned to the League, Duncan intensified his campaign; he was killed in battle in 3037.

At the time of Duncan's death, the Andurien campaign was going poorly for the League. To reflect this fact, the loyalist side suffers a -2 penalty to all Initiative die rolls in scenarios that take place during the first two years of the war, and the Andurien player may select his home map edge. However, loyalist troops have more and better forces than the scenario would normally call for. To reflect this, increase the loyalist side's point value by 10 percent if using the point system; otherwise, improve all loyalist pilots' skill modifiers by 1. After Thomas Marik took over the campaign, things went more smoothly for the Free Worlds' forces. Scenarios set during the last three years of the war can be played with standard rules.

**Attackers:** Free Worlds League loyalists (no allies)

**Defenders:** Duchy of Andurien (no allies)

## MAJOR WARS AFTER THE INVASION

Following are brief descriptions of the major wars that took place after the rediscovery of Star League technology and the coming of the Clans.

The following map shows the political borders of the Inner Sphere circa 3057. As in the previous section, only states that border one another may be involved in a conflict except when acting as allies of other combatants.

The Clan occupation zones did not exist until 3050; they gradually expanded from the top of the Inner Sphere, and reached the sizes shown by May of 3052. The disputed region known as the Chaos March did not develop until after the Marik-Liao Invasion of 3057.

## War of 3039 (3039)

During the brief but savage War of 3039, Theodore Kurita demonstrated his brilliant strategic ability by successfully defending the Draconis Combine from Hanse Davion's multi-front offensive. Because of the DCMS counterattack, battles took place on both sides of the front. Therefore, scenarios set during this war

can take place on Combine or Federated Commonwealth worlds, with either side being the defender. Both sides had excellent commanders, and the fighting was intense. To simulate this, apply a -1 penalty to all to-hit numbers. Also, if either player rolls "doubles" on his Initiative roll, that player can draw an additional command counter during the Command Phase of his turn. This special rule represents the quick changes in fortune that occurred during the war as well as the brilliant insight of the commanding officers.

**Side 1:** Federated Commonwealth (no allies)

**Side 2:** Draconis Combine (no allies)

## Clan Invasion (3049-3052)

The Clan's invasion of the Inner Sphere, code-named Operation Revival, sparked one of the largest and certainly the most one-sided war in the history of interstellar conflict. The invading Clan forces had greater skill, more advanced technology and the advantage of surprise. The Inner Sphere had the less valuable advantages of greater numbers and home terrain, which rarely proved sufficient to repel the invaders.

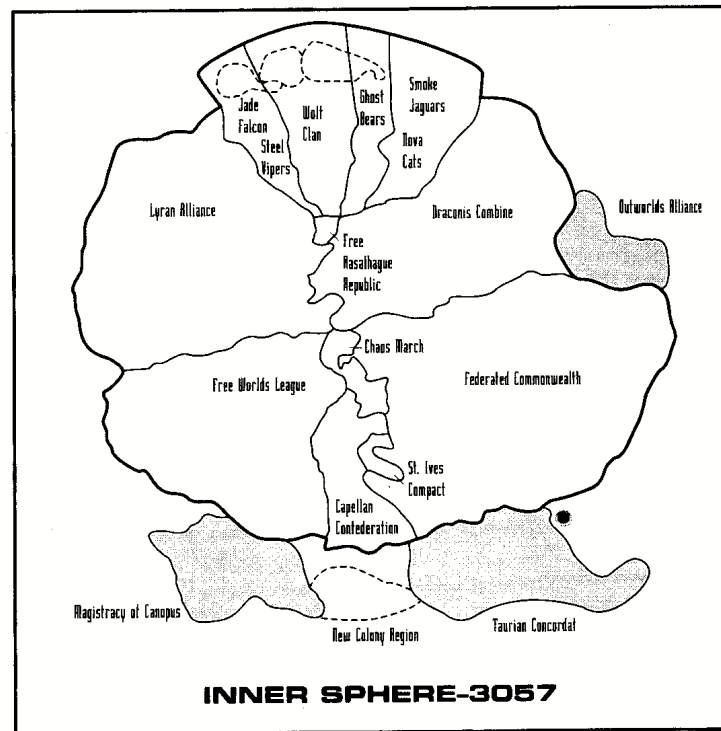

**INNER SPHERE-3057**

It is strongly recommended that players use the point system to choose forces for battles between the Clans and the Inner Sphere, as Clan 'Mechs are so much more powerful than Inner Sphere machines. The point system helps to mitigate this advantage. See also **Clan Honor** (p. 44) for details about the Clans' unusual battlefield tactics, which can further serve to balance forces in Clan Invasion scenarios.

**Attackers:** Clans Diamond Shark, Ghost Bear, Jade Falcon, Nova Cat, Smoke Jaguar, Steel Viper and Wolf (nominally allied forces)

**Defenders:** ComStar, Draconis Combine, Federated Commonwealth, Free Rasalhague Republic (allied forces)

# BATTLEFORCE

## Marik-Liao Invasion (3057)

Thomas Marik's son Joshua, being treated for leukemia by doctors at the New Avalon Institute of Science in the Federated Commonwealth, gave the Commonwealth leverage to keep the Free Worlds League from attacking it during the Clan invasion. Joshua Marik was essentially a hostage for his father's good behavior. When Joshua died, Archon Prince Victor Steiner-Davion enacted a plan set up by his late father Hanse, to conceal the boy's death by replacing him with a double.

Victor meant the substitution as a temporary measure until the tense situation between his half of the Federated Commonwealth and his sister's half—soon to secede as the Lyran Alliance—cooled off. However, agents of House Liao discovered the plan and Chancellor Sun-Tzu Liao revealed it to Thomas Marik. Understandably furious with Victor, Thomas publicly denounced his actions and declared war on the Federated Commonwealth. In addition to avenging the substitution scheme, Marik

meant to reclaim the Free Worlds League planets lost to the Federated Commonwealth during the Fourth Succession War. At the same time, the Capellan Confederation launched a campaign to reclaim territories it had lost to the Commonwealth, with the aid of mercenary units supplied by Marik.

Scenarios involving Marik forces can be played with standard rules. Most of the planets attacked by the Capellan Confederation had strong local support, in the form of pro-Liao rebels and guerrillas. To represent this fact, the Capellan player gets the following bonus forces for each unit he fields: a single 1-hex minefield (placed in any hex) and a single foot infantry platoon armed with rifles (designate their location as any hex on the map of the player's choice, after all other forces have set up). Group the infantry into as many three-element units as possible, with the remainder forming another unit, and place them according to the hidden units rules (p. 46). The Federated Commonwealth player may choose the mapsheets and his home map edge.

**Attackers:** Free Worlds League

**Allies:** Capellan Confederation

**Defenders:** Federated Commonwealth (no allies)



## The Refusal War (3057)

Operation Revival ended with the Battle of Tukayyid in May of 3052, where ComStar forces faced down a combined force from all the invading Clans in a proxy fight for control of Terra. ComStar won, and as a condition of the victory obtained a fifteen-year truce during which the Clans agreed not to advance any closer to Terra. Five years later, the Clan Grand Council, led by the pro-invasion Crusader faction, brought ilKhan Ulric Kerensky up on charges of conspiracy to destroy a Clan's genetic heritage. They claimed that the truce Ulric had negotiated with ComStar denied the new generation of warriors a chance to fight. Ulric disputed this charge and demanded a Trial of Refusal to overturn the decision. He bid his entire Wolf Clan to the Trial; Khan Elias Crichtell of Clan Jade Falcon also bid his entire Clan to defend the Grand Council's decision.

These two powerful Clans fought many quick and brutal battles that cost them both dearly in warriors and 'Mechs. In scenarios set during this war, the Wolf side receives a +1 bonus to all Initiative rolls. The Falcon player may always choose his home map edge and automatically wins the Initiative for the first turn.

**Attackers:** Clan Wolf (no allies)

**Defenders:** Clan Jade Falcon (no allies)

## BATTLEFORCE SCENARIO: CONVENTIONAL WISDOM

From her forward position, Star Commander Pene had a clear view of the fortress; her battle armor's IR-overlay showed the structure rising mountain-like from the plains. According to reports from the Watch, the Draconis Combine had assembled the entire structure in the years since Tukayyid, moving millions of tons of rock to create the artificial hill on which the fortress stood. Any enemy attempting to attack the structure would have to scale seventy-meter-high cliffs before reaching the walls—a formidable task, but not to the Star Commander.

Raised in a sibko on the Smoke Jaguar capital world of Huntress, Pene had encountered problems like this one as part of the basic training of Jaguar Elementals. That training was the reason why her unit had been assigned to secure an entry point into the fortress. The Elementals' thruster packs made the steep escarpment little more than an inconvenience. Of course, the warriors would have to hold the position until the 'Mech forces arrived. Star Commander Pene was looking forward to the challenge.

As the rest of the Nineteenth Striker moved into position, Pene checked her suit's systems one last time, then activated her Star's TacNet.

"All Point commanders, this is Pouncer Leader. Deploy on my mark. Mark!"

The thruster flames from twenty-five battle-armor suits lit up the night as the Elementals leapt toward their targets. Pene's altimeter showed her rising sixty meters; she shut off the thrusters, allowing momentum to carry her the rest of the way.

She never made it. As her suit crested the ridge, the 'Mechs and vehicles concealed behind the fortress's perimeter wall opened fire. She barely had time to register the deadly hail lancing out against her unit before a massive autocannon shell tore into her legs. Reacting to the grievous wound, the suit immediately pumped a massive quantity of pain-killing drugs into her body. She felt the impact as she struck the perimeter wall, but was mercifully unconscious before her suit plummeted the seventy meters to the base of the cliff.

### SITUATION

*Wazukana Fortress, Matamoras  
Pesht Military District, Draconis Combine  
27 July 3059*

After months of planning, the Inner Sphere began its first major counter-offensive against the Clans on 13 May 3059. The target was the strongest of the Crusader Clans, Clan Smoke Jaguar. United under the banner of a renewed Star League, the new Star League Defense Force (SLDF)—a multi-national force of elite units from across the Inner Sphere—launched a two-pronged attack with the goal of annihilating Clan Smoke Jaguar. This operation would strike at the Clan in the Inner Sphere and on the Jaguar homeworld of Huntress.

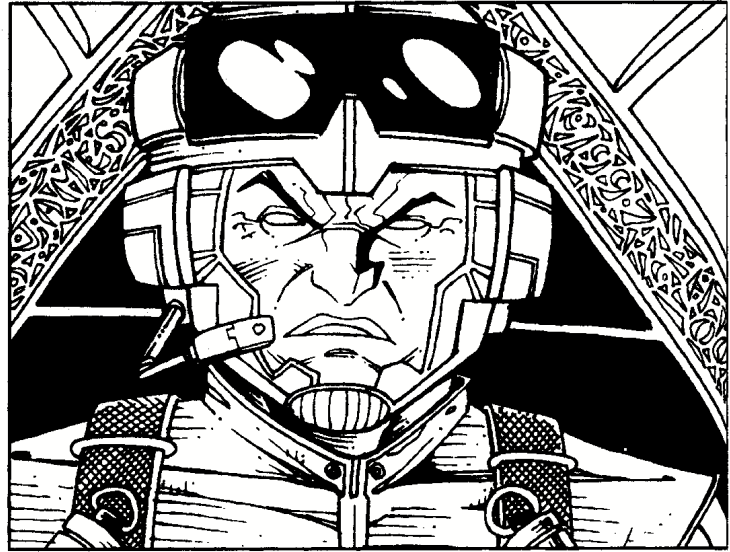

In the Inner Sphere portion of the offensive, dubbed Operation Bulldog, dozens of SLDF regiments overwhelmed the Jaguar positions in a lightning offensive designed to destroy them before they could react. The first and second waves of the offensive went off well ahead of schedule, leading the Inner Sphere commanders to step up the pace of the assault.

In anticipation of a third wave, the Jaguars counterattacked into the Draconis Combine. Expecting the enemy to be overextended and vulnerable, the Jaguar troops were dismayed to find their targets garrisoned by the SLDF reserve—some of the best units from throughout the Inner Sphere—along with a Combine civilian population who had spent more than seven years preparing.

On Matamoras, the Nineteenth Jaguar Striker Cluster encountered the First Free Worlds Guards, one of Thomas Marik's crack units, together with the Second Nightstalker regiment. The Strikers reacted in typical Clan fashion: they attacked.

### GAME SETUP

Lay out both **BattleForce 2** maps as shown. Also lay out the support map.

To represent the Wazukana fortress, place building counters on the west mapsheet in the following hexes: Fortress counters in Hexes 1109 and 1110; City counters in Hexes 0808, 0809, 0810, 0911, 1007, 1008, 1009 and 1209; Base counters in Hexes 0709, 0710, 0711, 0811, 0912, 1107 and 1108.

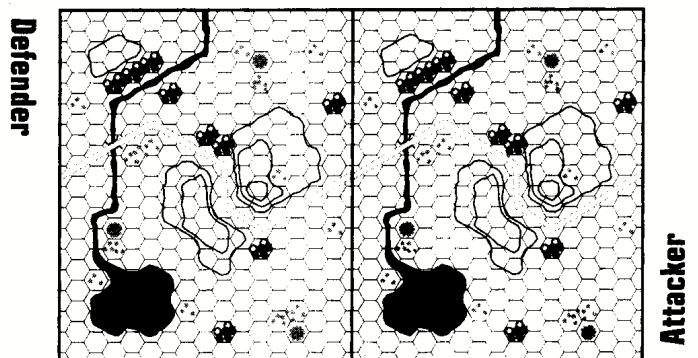

## Delta Galaxy 19th Striker Cluster

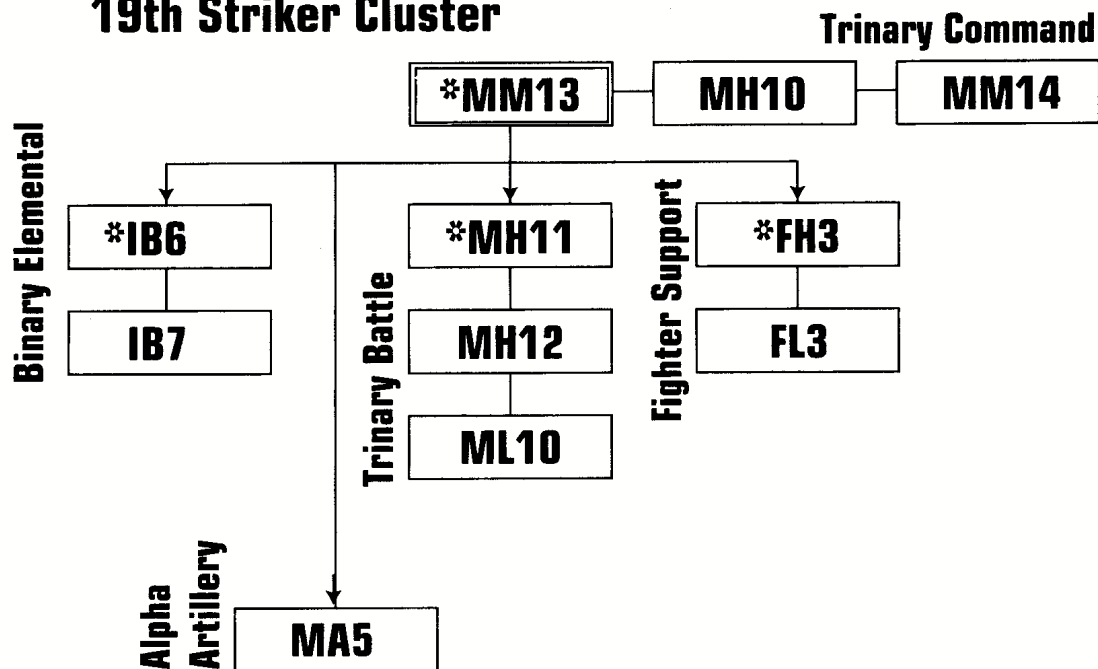

### ATTACKER

The attacker consists of elements of the Jaguar Nineteenth Striker Cluster, Delta Galaxy. Units marked with an asterisk (\*) are command units. Each command unit's subordinate units (its chain of command) appear in brackets [] after the asterisk.

#### Trinary Command

Alpha Star (MM13)\* [MH10, MA4, MH11, IB6, FH3, MA5]

*Shadow Cat Prime, Elite*  
*Ryoken Prime, Veteran*  
*Shadow Cat B, Veteran*  
*Black Hawk Prime, Veteran*  
*Loki Prime, Veteran*

Bravo Star (MH10)

*Ryoken A, Elite*  
*Thor Prime, Elite*  
*Vulture Prime, Veteran*  
*Cauldron-Born Prime, Elite*  
*Thor Prime, Veteran*

Charlie Star (MM14)

*Vulture B, Elite*  
*MadCat B, Elite*  
*Black Hawk A, Veteran*  
*Grendel Prime, Veteran*  
*Ryoken A, Elite*

#### Trinary Battle

Alpha Star (MH11)\* [MH12, ML10]

*Mad Cat Prime, Veteran*  
*Vulture Prime, Veteran*  
*Vulture B, Elite*  
*Loki Prime, Elite*  
*Night Gyr Prime, Veteran*

Bravo Star (MH12)

*Ryoken D, Elite*  
*Vulture C, Veteran*  
*Cauldron-Born Prime, Elite*  
*Mad Cat A, Veteran*  
*Masakari B, Veteran*

Charlie Star (ML10)

*Koshi A, Elite*  
*Puma A, Veteran*  
*Puma C, Veteran*  
*Koshi Prime, Elite*  
*Uller Prime, Elite*

#### Binary Elemental

Alpha Star (IB6)\* [IB7]

Elemental Point w/Small Lasers, Elite  
 Elemental Point w/Small Lasers, Veteran  
 Elemental Point w/Small Lasers, Veteran  
 Elemental Point w/Machine Guns, Elite  
 Elemental Point w/Machine Guns, Veteran

Bravo Star (IB7)

Elemental Point w/Small Lasers, Veteran  
 Elemental Point w/Small Lasers, Elite  
 Elemental Point w/Small Lasers, Veteran  
 Elemental Point w/Machine Guns, Elite  
 Elemental Point w/Machine Guns, Elite

#### Support Units

Alpha Fighter Point (FH3)\* [FL3]

*Sabutai Prime, Veteran*  
*Sabutai Prime, Veteran*

Bravo Fighter Point (FL3)

*Batu A, Veteran*  
*Batu A, Veteran*

Alpha Artillery Point (MA5)

*Naga Prime, Veteran*

# BATTLEFORCE

## 1st Free Worlds Guards 2nd Battalion

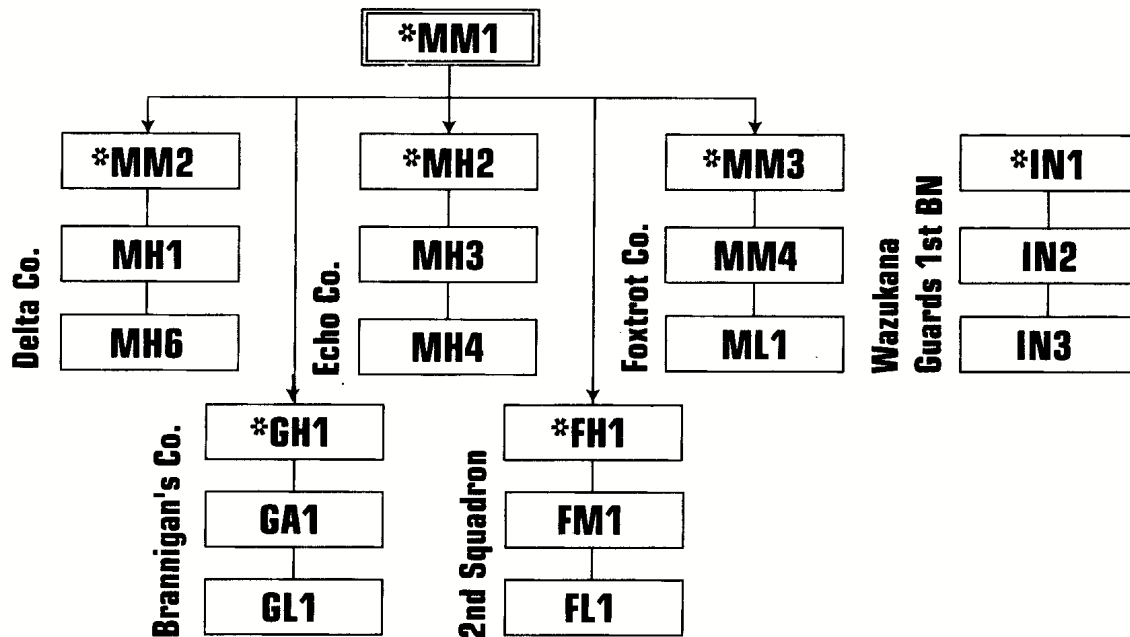

### Deployment

Apart from the support units, the Nineteenth Strikers start the game in Box 0 on their side of the support map, and will enter via the east map edge during the Movement Phase of Turn 1.

Alpha and Bravo fighter Points deploy in Box 6 on the Jaguar side of the support map. Alpha Artillery Point deploys in Box 1 on the Jaguar side of the support map.

### DEFENDER

The defenders are elements of the First Free Worlds Guards regiment, fighting under the banner of the SLDF. Units marked with an asterisk (\*) are command units. Each command unit's subordinate units (its chain of command) appear in brackets [] after the asterisk.

### Guards 2nd Battalion

Command Lance (MM1)\* [MM2, MH2, MM3, GH1, FH1]

- PXH-3M *Phoenix Hawk*, Elite
- HBK-5M *Hunchback*, Veteran
- GRF-3M *Griffin*, Elite
- CDA-3M *Cicada*, Veteran

### Delta Company

Command Lance (MM2)\* [MH1, MA1]

- SHD-5M *Shadow Hawk*, Veteran
- CDA-3M *Cicada*, Regular
- GRF-3M *Griffin*, Veteran
- TDR-5S *Thunderbolt*, Veteran

Strike Lance (MH1)

- WHM-7M *Warhammer*, Elite
- TMP-3M *Tempest*, Elite
- RFL-5M *Rifleman*, Veteran
- MAD-5M *Marauder*, Veteran

Support Lance (MH6)

- WHM-7M *Warhammer*, Elite
- OTL-5M *Ostsol*, Veteran
- ON1-M *Orion*, Veteran
- CP-11-A *Cyclops*, Regular

### Echo Company

Command Lance (MH2)\* [MH3, MH4]

- QKD-5M *Quickdraw*, Elite
- WHM-6R *Warhammer*, Veteran
- ARC-4M *Archer*, Veteran
- ARC-4M *Archer*, Elite

Assault Lance (MH3)

- ON1-K *Orion*, Veteran
- MAD-5M *Marauder*, Veteran
- CRD-3R *Crusader*, Regular
- STK-3F *Stalker*, Veteran

Pursuit Lance (MH4)

- TMT-7M *Trebuchet*, Elite
- WR-DG-02FC *War Dog*, Veteran
- ON1-M *Orion*, Veteran
- ARC-4M *Archer*, Regular

### Foxtrot Company

Command Lance (MM3)\* [MM4, ML1]

- TR1 *Wraith*, Veteran
- WVR-7M *Wolverine*, Veteran
- GRF-3M *Griffin*, Regular
- GRF-3M *Griffin*, Veteran

Force Lance (MM4)

- HMR-3M *Hammer*, Veteran
- BJ2-OE *Blackjack*, Veteran
- GRF-3M *Griffin*, Regular
- CDA-3M *Cicada*, Regular

# BATTLEFORCE

## Recon Lance (ML1)

- WSP-3M *Wasp*, Veteran
- ZPH-1A *Tarantula*, Regular
- OTT-7J *Ostscout*, Regular
- WSP-3M *Wasp*, Regular

## Brannigan's Company

### Command Lance (GH1)\* [GA1, GL1]

- Schreck PPC Carrier, Veteran
- Schreck PPC Carrier, Regular
- Pike Support Vehicle, Veteran
- Pike Support Vehicle, Veteran

### Assault Lance (GA1)

- Ontos Heavy Tank (3058), Veteran
- Ontos Heavy Tank (3058), Regular
- Demolisher Heavy Tank, Regular
- Demolisher Heavy Tank, Regular

### Strike Lance (GL1)

- Galleon Light Tank, Regular
- Galleon Light Tank, Regular
- Scimitar Medium Hover Tank, Veteran
- Scimitar Medium Hover Tank, Regular

## Wazukana Guards

### 1st Battalion

#### Command Company (IN1)\* [IN2, IN3]

- Foot Machine Gun Platoon, Veteran
- Foot Machine Gun Platoon, Veteran
- Foot Machine Gun Platoon, Regular

#### Strike Company (IN2)

- Motor Rifle Platoon, Veteran
- Motor Machine Gun Platoon, Veteran
- Motor Machine Gun Platoon, Veteran

#### Recon Company (IN3)

- Jump Rifle Platoon, Veteran
- Jump Machine Gun Platoon, Veteran
- Jump SRM Platoon, Veteran

### 1st Guards Aerospace Wing

#### 2nd Squadron

##### Alpha Air Lance (FH1)\* [FM1, FL1]

- TR-13 *Transgressor*, Elite
- TR-13 *Transgressor*, Veteran

##### Beta Air Lance (FM1)

- F-90 *Stingray*, Elite
- F-90 *Stingray*, Veteran

##### Gamma Air Lance (FL1)

- F-10 *Cheetah*, Veteran
- F-10 *Cheetah*, Veteran

## Deployment

The Guards deploy first. They may begin the game anywhere on either mapsheet, with the exception of the Second Squadron of aerospace fighters. Those fighters start the game in Box 6 on the SLDF side of the support map.

## VICTORY CONDITIONS

The scenario ends when all of the attacking or defending units have been destroyed, or when all the buildings have been destroyed. The attacker wins by destroying all of the buildings and fortresses, along with as many SLDF units as possible. The defender wins by destroying as many attacking units as possible while preventing the destruction of the buildings.

Action	Victory Points
Clan 'Mech or fighter element destroyed	+2
Elemental Point destroyed	+1
Inner Sphere 'Mech, vehicle or fighter destroyed	-2
Inner Sphere infantry platoon destroyed	-1
Building destroyed	-2

## VICTORY TABLE

Point Total	Result
-50 or less	Decisive Clan Victory
-49 to -31	Substantial Clan Victory
-30 to -16	Marginal Clan Victory
-15 to -1	Draw
0 to 1	Marginal Inner Sphere Victory
12 to 29	Substantial Inner Sphere Victory
30 or more	Decisive Inner Sphere Victory

To determine the victory level, calculate each side's total points and consult the Victory Table.

## COMMAND LISTS

The following command lists apply to this scenario.

Counter Number	Inner Sphere	Counter Number	Clan
1	Alpha Strike!	11	Alpha Strike!
2	Stand and Shoot	12	Alpha Strike!
3	Charge!	13	Doubletime March
4	Doubletime March	14	Evasive Action
5	Evasive Action	15	Hello, HQ?
6	Hello, HQ?	16	Ambush
7	Alpha Strike!	17	Stand and Shoot
8	Stand and Shoot	18	Stand and Shoot
9	Careful Aim	19	Careful Aim
10	Careful Aim	20	Death from Above

## AFTERMATH

Conventional wisdom dictates that an army does not split its forces in the face of a superior enemy. However, Clan arrogance makes it very difficult for them to recognize any non-Clan force as superior. The Smoke Jaguars viewed the Free Worlds League regiment, untested against Clan forces, with particular disdain, and Star Colonel Thilla Showers refused to accept the elite fighting abilities of the Guards on Matamoros.

The Nineteenth besieged two battalions of the Guards in Wazukana fortress, seeking to shatter the unit and destroy the supply dump there. A series of probing raids against the Marik positions showed there was little chance of the Guards vacating the fortress, and so Showers resorted to a tactic that had rarely failed the Clans: frontal assault.

In an open field engagement the Strikers might have carried the day, but against a talented foe with both numerical superiority and a solid defensive position, the attack was the last gasp of a dying Clan. The Strikers penetrated the Guards' perimeter, but lost many units doing so. Only two Stars made it into the fortress, and both failed to inflict significant damage before they were eliminated.



## PLANETARY ASSAULT

**Planetary Assault** is the **BattleForce 2** game of all-out war on a global scale. This game system lets you play out an entire campaign, from the arrival of forces in a planetary system to each battle on the planet's surface. **Planetary Assault** can be played as a game in its own right, or used in conjunction with **BattleForce** and **BattleTech** as a framework for planetary landings and strategic maneuvering. Once the fighting forces clash, players can resolve battles quickly and easily using the **Planetary Assault** rules, or can fight each battle in detail using the **BattleForce** rules.

This section offers an overview of the **Planetary Assault** game, including game components and rules for game setup, sequence of play and setting up scenarios. It begins with a brief discussion of the nature of planetary assault warfare in the **BattleTech** universe.

### THE MECHANICS OF ASSAULT

The nature of interstellar transport in the thirty-first century creates a specific pattern for planetary assault determined by the technology that makes interstellar warfare possible: JumpShips and DropShips.

#### JUMPSHIPS

The JumpShip is a key vehicle in launching a planetary assault. These large interstellar transport vessels contain a Kearny-Fuchida hyperspace jump drive (KF drive) that allows instantaneous transportation across distances of up to thirty light-years. The KF drive is expensive, delicate and very large, taking up roughly 95 percent of the ship's mass. It leaves little room for armor, weapons or cargo, and certainly cannot support an interplanetary drive to propel the ship from its arrival point in the planetary system to the target planet. For this job, a JumpShip carries one or more DropShips.

Some JumpShips—known as combat JumpShips or WarShips—are equipped with compact drive cores, allowing them to mount considerable armor and weapons as well as the massive interplanetary drives. WarShips are rare in the Inner Sphere, as the technology used to create the compact drives was lost long ago in the wars that have wracked that region of space for centuries. The Clans, however, preserved the technology and currently boast a sizable navy. With sophisticated technical aid from ComStar, the realms of the Inner Sphere

have recently begun rebuilding their WarShip navies, though the process is a slow one.

In the **BattleTech** universe, JumpShips are not considered military targets. Ever since the brutal Second Succession War, an unspoken ban on attacking JumpShips has preserved humankind's ability to travel across interstellar space. WarShips, of course, are an exception to this rule.

#### Jump Points

In order to make a hyperspace jump, the KF drive creates an energy bubble around the ship that "punches a hole" through space. Because this bubble cannot form properly in the presence of a strong gravitational field, a JumpShip most often enters a planetary system through one of the system's two closest points of gravitational stability: at the zenith or nadir of a system's gravity well, along the line that passes through the system's gravitational center and perpendicular to the plane of the star system (see diagram).

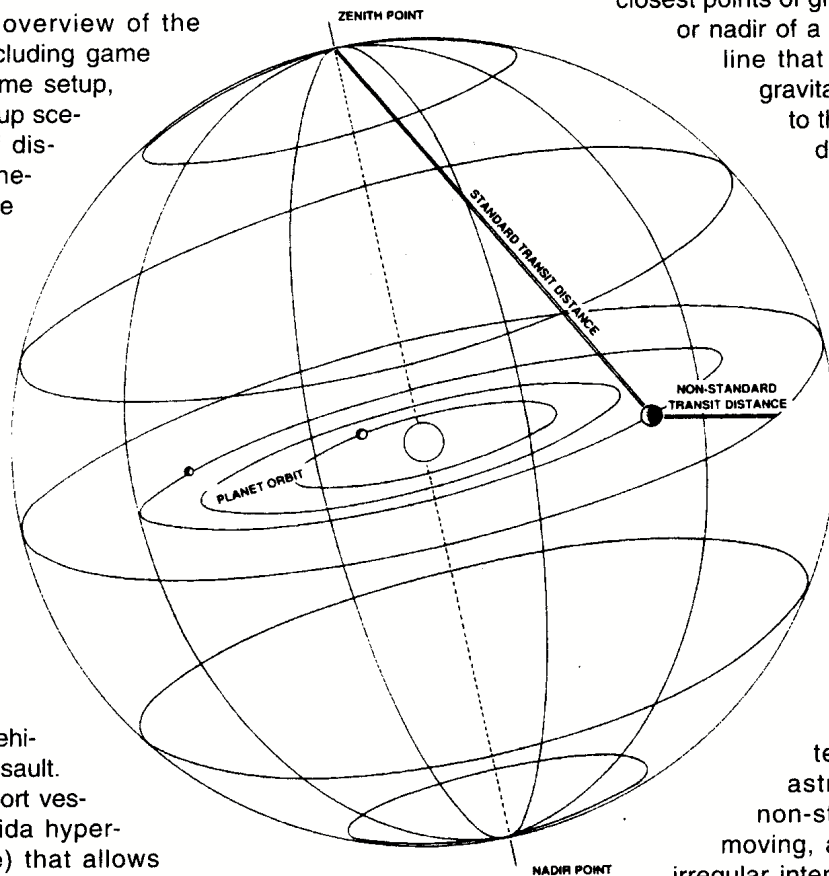

#### Pirate Points

The zenith and nadir are the most commonly used jump points, especially for civilian traffic, but are not the only options. Alternate jump points exist in a sphere around the system's star, as well as at other points of gravitational stability in the system (called Lagrange points). Unlike the zenith and nadir points, these non-standard points do not have fixed locations. The complex gravitational interaction of the system's stars, planets and other astronomical bodies means that non-standard points are constantly moving, appearing and disappearing at irregular intervals. This characteristic makes calculating such points extremely difficult.

Additionally, vessels using non-standard points stand far less chance of being rescued in the event of a malfunction than those using standard points. For this reason, non-standard points are generally used in emergencies or by JumpShip crews seeking to conceal their arrivals in star systems, such as pirate vessels—a fact that earned non-standard jump points the nickname of pirate points.

#### Detection

An emerging JumpShip creates a powerful electromagnetic (EM) pulse, detectable at the target planet within hours of the jump. Though it is possible for an enemy JumpShip to avoid detection by the planet it intends to target, the means of accomplishing this feat are few and difficult. By learning the enemy's shipping patterns, for example, an attacking force might devise



# PLANETARY ASSAULT

## STANDARD CAMPAIGN TIMETABLE

The following timetable represents the standard progression of a limited military objective raid. Time intervals represent the days before and after the projected drop to the planet's surface.

### D - 14 Days

The regimental assault force breaks out of hyperspace. Because it is dangerous to use the Kearny-Fuchida drive inside a star system's gravity well, the regiment's DropShips arrive more than 640 million kilometers away from the target planet. Even at full sub-light speed, the assault force will take nearly two weeks to reach its target.

### D - 2 Days

The regiment arrives in orbit around the invasion target. The aerospace fighters carried aboard its DropShips launch and engage any enemy fighters in orbit. They must destroy or drive off these enemy fighters before their BattleMechs can land.

### D - 1 Day

Once the defending aerospace forces have been defeated, the invasion force's surviving fighters may be sent to attack ground-based radar stations and missile batteries near the intended BattleMech regiment drop point. These installations are usually present only on heavily defended worlds, and most invasion commanders prefer not to risk their fighters in atmospheric combat.

### D-Day (Drop Day)

The attacker's DropShips enter the planet's atmosphere and land on the surface. The invasion commander usually chooses a drop point several hundred kilometers away from the enemy BattleMech garrison, allowing him to organize his force and repair any minor damage sustained while landing.

### D + 1 Day

The BattleMech regiment begins advancing against enemy positions. Light BattleMech units are detached to make lightning-quick raids against the planetary garrison's supply points, repair facilities and surviving aerospace fighter bases. The rest of the regiment advances behind a screen of light and medium BattleMechs.

### D + 2 Days and Beyond

The main invasion force makes contact with the defending planetary garrison. The defending BattleMechs probably will have occupied positions in and around water sources such as lakes, streams and shallow rivers. The side that controls the water has an obvious tactical advantage, and most of the fighting will take place around those positions. The garrison will have to hold out for at least six weeks before it can expect to receive any reinforcements. If they are badly outnumbered, the defenders may split up into small units (usually lances) and operate as a guerrilla force, harassing the invaders but refusing to engage in pitched battles.

a way to knock out or delay an enemy JumpShip and send one of their own to take its place. The arriving ship, however, would need to broadcast appropriate identification codes to maintain the charade. The sheer logistical difficulty of managing all this makes such deceptions a rare tactic; therefore, in practice, the enemy will almost always detect an arriving JumpShip and be ready to meet the invasion force head-on.

## DROPSHIPS

Carried by JumpShips, DropShips transport troops and equipment from the system's jump point to the target planet. DropShips are equipped with fusion-powered interplanetary drives that propel them through space. Most DropShips are transport vessels, with their mass divided between engines and cargo. Many are also equipped with armor and weapons to defend themselves and their passengers if necessary. A large military DropShip often boasts more firepower than a company of BattleMechs. Some DropShips, known as assault ships, have little or no space for transporting troops or cargo, but are bristling with weapons intended to hunt down enemy DropShips.

After the JumpShip arrives at the jump point, the DropShips it is carrying detach from their docking collars and begin the long trip in-system. Depending on the size of the star and other factors, the trip can take hours, days or even weeks in the case of very large stars. A typical system transit takes a week to ten days.

Upon arrival in orbit around the target planet, the DropShip lands and unloads its cargo—usually well behind friendly lines, as DropShips are expensive and may play a vital role in the event of a tactical withdrawal.

## Combat Drops

Sometimes, battlefield conditions call for landing troops closer to the enemy than a DropShip can feasibly approach—even in the midst of enemy forces. In these cases, a commander can call for a combat drop, a risky deployment technique made possible by the unique construction of BattleMechs and battle-armored troops. In a combat drop, rather than the DropShip landing on the planet's surface, the troops jump out of it at low altitude and fall to the surface. This tactic avoids the necessity of risking the DropShip by landing it in hazardous terrain or in the middle of enemy lines, while allowing rapid troop deployment directly to such areas. The dropped forces land safely by using jump jets or disposable jump packs to slow and guide their descent—though even with this equipment, combat drops remain extremely hazardous. Even well-trained pilots can damage their 'Mechs if they make a minor altitude miscalculation or a slightly off-balance landing. For these reasons, combat drops are used only when absolutely necessary.

Combat drops can also be made from very high or orbital altitudes if the dropped forces are encased in ablative cocoons that burn away during atmospheric entry.

## COMPONENTS

With the exception of the two terrain mapsheets and certain counters, all of the contents of the **BattleForce 2** box can be used to play **Planetary Assault**.

## MAPSHEETS

The **Planetary Assault** map represents an entire planetary surface, on a far different scale from **BattleTech** or standard **BattleForce**. Two mapsheets join together to form the planetary map, as shown on p. 73.

# PLANETARY ASSAULT

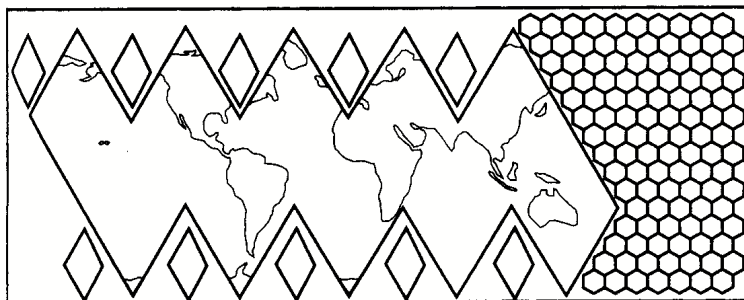

Each hex on the planetary map is roughly 1,500 kilometers across, making the planet shown approximately the size of Earth (Terra). Each hex in the System Diagram is approximately 100 million kilometers across, though the exact scale on that map is not important to game play.

## Planetary Surface

In order to represent a spherical shape on a flat mapsheet, the planetary map divides the planet's surface into twenty triangular flat planes. If cut out and folded together, the map would form a twenty-sided, roughly round solid, much like a 20-sided dice.

Half-hexes on the map are considered to be the same hex as their other half, regardless of the half in which the counter is placed. This is particularly important when players' units are at the far left and right edges of the map. Also, all of the tips of the triangles that represent the poles—five to the north and five to the south—are considered the same hex (one North Pole hex and one South Pole hex). These factors make travel around the globe considerably faster for players whose forces are closer to the poles than to the equator. The example below shows some sample unit placements on the planetary map.

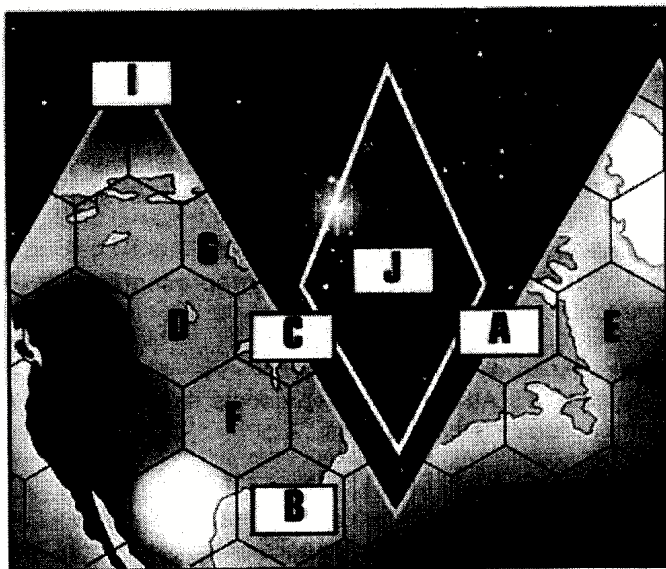

*Unit A is adjacent to both Unit B and Unit C because Unit A occupies a half-hex. The other half of the hex is the empty one to its left. Even though its counter is standing only in the right half of the hex, Unit A is considered to occupy both halves.*

*If Unit C moves one hex overland, it can occupy Hex D, E, F, G or the hex occupied by Unit A.*

*Unit I is on the North Pole hex (Hex A01). It therefore occupies the entire pole, not just the tip of the pole on which the counter is standing.*

*Unit J is an aerospace unit in Orbit Zone 5. It is adjacent to neither Unit C nor Unit A because it is in orbit. It is, however, considered to be orbiting over the area of the planet occupied by Unit A.*

## Terrain

Various types of terrain are depicted on the map to represent the different environments found on a planet's surface. The planetary map has fewer terrain types than **BattleTech** and **BattleForce** because of the change in scale; the distinction between Light Woods and Heavy Woods, for example, is negligible. Also, because each hex covers so much territory, the terrain is vastly simplified. The predominant terrain in each hex is represented on the map even though variation certainly exists in each hex on a smaller scale.

On the planetary map, each terrain type is identified by color. For easy reference, a black-and-white representation of the map of Terra is included on page 139.

**Plains:** Light green hexes denote plains, a type of terrain that includes fields, meadows and other grasslands. Plains is the basic terrain type in **Planetary Assault**, and has no effect on movement or combat.

**Woods:** Dark green hexes indicate woods, which includes other tree-covered terrain or difficult ground such as jungles and swamps. Woods slow troop movement, but can also provide useful cover.

**Mountains:** Brown hexes represent mountain regions, terrain that includes very rough or hazardous ground such as volcanic fields. This type of terrain is extremely difficult to cross, but can provide substantial cover.

**Water:** Blue indicates the presence of water in a hex. Hexes filled with water are called Ocean hexes and can only be crossed by naval, aerospace and VTOL units. Hexes with some water in them represent inlets, lakes or rivers and can be crossed by land units in certain circumstances (see **Crossing Water Hexes**, p. 80).

**Desert:** Yellow hexes represent deserts: hot regions with little water covered in shifting sand, as well as other types of badlands. Desert terrain slows the movement of ground units and intensifies overheating problems in BattleMechs.

**Arctic:** White hexes are arctic hexes, covered in permafrost or hard-pack ice. These hexes slow the movement of ground units, but BattleMechs moving through them have less trouble with heat. These hexes are always considered neutral unless occupied (see **Control**, p. 77).

## Map of Terra

The map of Terra provided in the **BattleForce 2** box is only one example of a possible planetary terrain. The back of the map provides a blank planet to fill in with your own planetary designs. FASA grants permission to photocopy the backs of those mapsheets for personal use only. The map of Terra, because it is based on the real planet earth, includes coastlines that sometimes conflict with the printed hex grid. The following rules regarding the terrain of specific hexes are intended to help

TECH

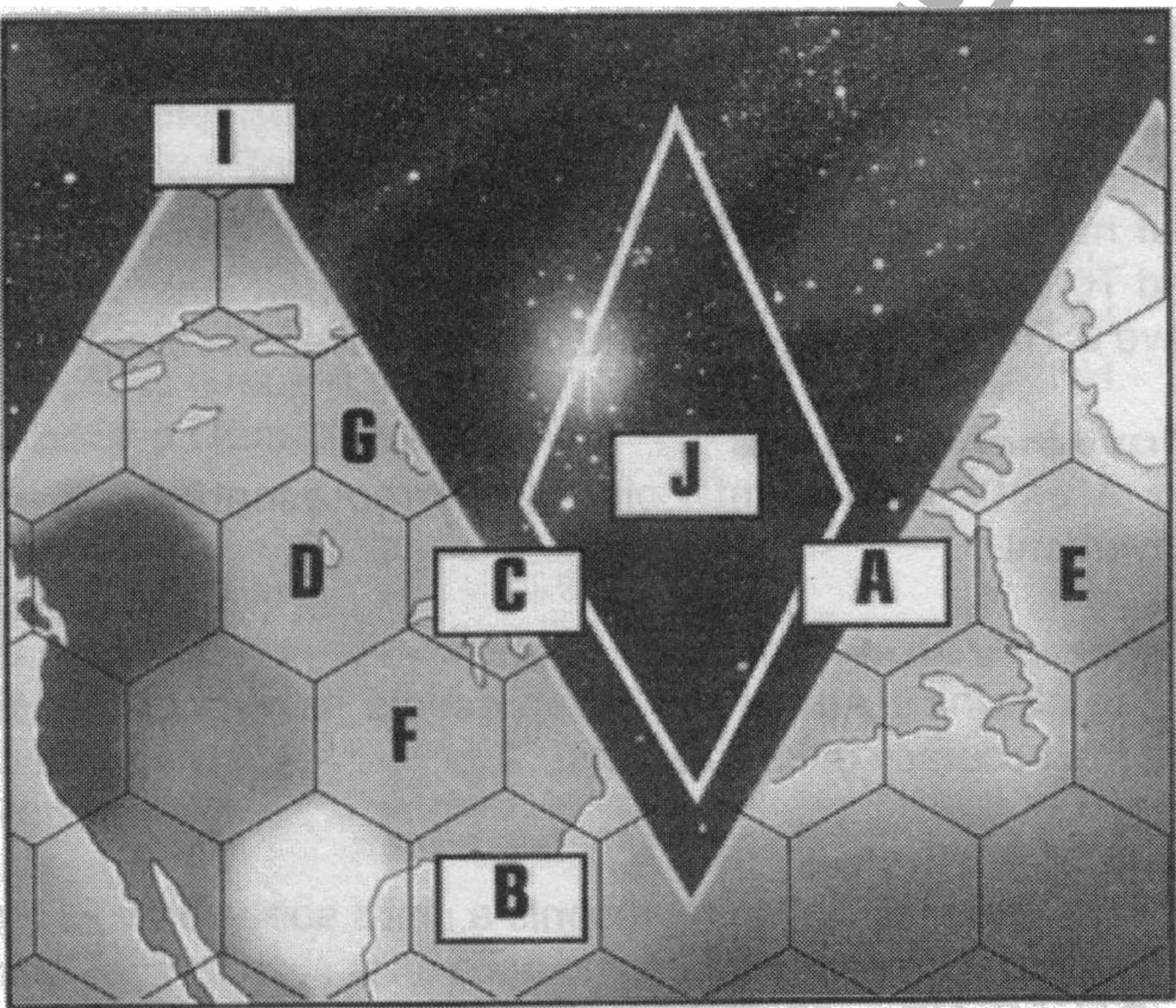

РУССКО

# PLANETARY ASSAULT

## UNIT REFERENCE TABLE: INNER SPHERE

UNIT TYPE	Counter ID	MP	Attack	Defense	Toughness	Transport
<b>BattleMech Units</b>						
Light 'Mech Co (IS)	ML	3	1	8	6	—
Med 'Mech Co (IS)	MM	2	2	6	8	—
Hvy 'Mech Co (IS)	MH	1	3	5	10	—
Assault 'Mech Co (IS)	MA	1	4	4	12	—
Light 'Mech Co (IU)	ML	4	1	8	5	—
Med 'Mech Co (IU)	MM	3	2	7	7	—
Hvy 'Mech Co (IU)	MH	2	4	6	9	—
Assault 'Mech Co (IU)	MA	1	6	4	11	—
<b>Ground Vehicle Units</b>						
Light Vehicle Co	GL	4	2	7	3	—
Med Vehicle Co	GM	3	4	6	5	—
Hvy Vehicle Co	GH	1	6	5	7	—
Assault Vehicle Co	GA	1	8	3	9	—
Supply Convoy	GC	2	0	5	4	—
Ground Trans Co	GT	2	2	6	5	2
Artillery Co	AR	1	4*	3	3	—
<b>VTOL Units</b>						
Attack VTOL Co	VA	5	2	9	4	—
Air Trans Co	VT	4	1	6	4	1
<b>Naval Units</b>						
Naval Trans Co	NT	2	2	5	6	3
Submarine Co	NS	2	6	4	7	—
<b>Infantry Units</b>						
Infantry Bn	IN	1	2	3	7	—
Battle Armor Co (IS)	IB	1	3	4	8	—
<b>Aerospace Fighter Units</b>						
Light Fighter Sqd (IS)	FL	8	2	10	5	—
Med Fighter Sqd (IS)	FM	7	4	9	7	—
Hvy Fighter Sqd (IS)	FH	6	6	8	9	—
Light Fighter Sqd (IU)	FL	8	3	10	4	—
Med Fighter Sqd (IU)	FM	7	5	9	6	—
Hvy Fighter Sqd (IU)	FH	6	7	8	8	—
<b>DropShip Groups (3 DropShips per group)</b>						
DropShip Group (Sm Trans)	DL	6	3	8	10	3
DropShip Group (Med Trans)	DM	5	4	6	11	6
DropShip Group (Lg Trans)	DH	4	6	4	12	9
DropShip Group (Assault)	DA	6	6	6	10	—
JumpShip	JU	0	0	3	8	—
<b>WarShips</b>						
Small WarShip	WM	3	10*	5	13	—
Large WarShip	WH	2	12*	4	14	—
Space Station	SP	0	2	2	10	—
<b>Settlements</b>						
Fortress	T	0	4*	2	14	—
City	C	0	0	2	12	—
Base	B	0	2	2	8	—

\*This unit can attack non-adjacent units. See **Planetary Combat**, p. 84.

### Transport Capacity

A unit with Transport Capacity can carry other units. In the case of ground vehicle units, the Transport Capacity represents how many infantry units the vehicles can carry. DropShips can carry any type of ground or aerospace fighter unit.

### Quality Rating

A unit's Quality Rating represents its skill and experience in battle. As in **BattleForce**, each unit has a Quality Rating of Green, Regular, Veteran or Elite, represented by a skill modifier that applies to combat and other die rolls as necessary (see To-Hit Modifiers Table, p. 86). A unit with no assigned Quality Rating is assumed to be Regular.

# PLANETARY ASSAULT

players resolve any disputes regarding terrain. Players also may create house rules regarding terrain interpretations for these hexes if they choose.

Hexes that only contain a tiny amount of land are considered Ocean hexes. The following hexes that contain tiny portions of land should be considered Ocean hexes (containing no land) for game purposes: B06, G10, H22, I16, L13, L18, and N13.

Though they are not marked on the planetary map because they are too small to be seen from orbit, hexes H10 and F18 contain canals.

Some hexes contain land from both sides of a body of water, but a land crossing there actually should not be possible. For example, the northwest corner of Hex E01 is not considered to contain land. As a result, the hex does not contain land from both mainland Asia and Japan, making a land crossing there impossible. A ground unit occupying Hex E01 is considered to be in Japan.

The following portions of the listed hexes also should not be considered to contain land: Hex B16 (SE hexside and corner), Hex C16 (NW and W hexsides), Hex E01 (NW corner), Hex G19 (N corner), Hex H19 (N corner), Hex I23 (SW corner and W hexside), and Hex J01 (NW hexside). Also, Hex B11 only contains land for Greenland. The portions of Canada in the south part of the hex are considered water.

## Space

Space is represented in two ways on the **Planetary Assault** map. Space near the planet is represented by ten orbit zones—numbered, diamond-shaped areas around the edges of the planetary map. Each orbit zone corresponds to an adjacent diamond-shaped portion of the ground, as indicated by dashed lines on the ground areas and solid lines connecting each ground area with an orbit zone. Units placed in a particular orbit zone are orbiting over the corresponding segment of the planet.

Deep space is shown on the System Diagram on the right-hand side of the planetary map. The diagram shows four planetary orbits—Venus, Terra, Mars and Jupiter—and the system's star, as well as the zenith, nadir and pirate jump points. The numbers shown in the jump point hexes represent the target number needed to jump to those hexes (see **Deep Space Movement**, p. 81 in **Planetary Movement**). Hex 0803 represents Terra.

## BATTLE BOARD

The battle board is the reverse side of the **BattleForce** support map. Players use it to resolve combat between units occupying the same hex or orbit zone on the planetary map. The battle board is divided into twenty-five boxes, each of which represents an abstract position on the battlefield rather than a particular real-world distance. During battle, units move from box to box to maneuver into position, attempting to protect their vulnerable flanks and rear while outflanking the enemy.

The nine boxes in the center of the battle board are shaded to indicate that the terrain in them is the terrain in the hex on the planetary map in which the combat is taking place. For more information regarding the battle board, see **Planetary Combat**, p. 84.

Reserve	Reserve	Reserve	Reserve	Reserve
Right	Right	Main	Left	Left
Left	Left	Main	Right	Right
Reserve	Reserve	Reserve	Reserve	Reserve

## COUNTERS

Counters represent units and settlements on the game map. Unit counters represent formations of forces; other counters represent settlements. Certain types of counters, such as ECM and objective counters, are not used in **Planetary Assault** unless specifically called for in a scenario.

Each unit in the game represents a single company, battalion or other large formation. In the case of JumpShips and WarShips, a unit represents a single vessel. The Unit Reference Tables, beginning on p. 75, list unit sizes as well as relevant game statistics for all Inner Sphere and Clan unit types. In some cases, the Unit Type is followed by a technology code in parentheses: Inner Sphere Standard (IS), Inner Sphere Upgraded (IU), Clan Front-Line (C1) or Clan Second-Line (C2).

Even though a unit occupies an entire hex on the game map, it is assumed to be dispersed throughout the hex in smaller divisions, effectively controlling the area that the hex represents.

Unit types are abstracted on the planetary scale; for example, all Medium Vehicle units are considered to be the same regardless of each unit's specific composition. If players want to fight battles in more detail, they can break each unit down into **BattleForce**-scale sub-units and resolve combat on the **BattleForce** scale (see **Integration**, p. 104).

In **Planetary Assault**, each unit's abilities are defined by four numbers: Movement Points, Attack Value, Defense Rating and Toughness Rating. Units that can transport other units also have a Transport Capacity, and all units have a Quality Rating.

### Movement Points

A unit's Movement Points (MP) represent its speed of movement.

### Attack Value

Each unit's Attack Value represents its overall firepower and the accuracy of its weapons.

### Defense Rating

The Defense Rating represents a unit's ability to avoid being hit by attacks. In general, fast and agile units such as light 'Mechs have higher (more effective) Defense Ratings because they can dodge and hide better than their slower counterparts.

### Toughness Rating

A unit's Toughness Rating is derived from its armor and overall durability, and represents its resistance to damage.

# PLANETARY ASSAULT

## UNIT REFERENCE TABLE: INNER SPHERE

UNIT TYPE	Counter ID	MP	Attack	Defense	Toughness	Transport
<b>BattleMech Units</b>						
Light 'Mech Co (IS)	ML	3	1	8	6	—
Med 'Mech Co (IS)	MM	2	2	6	8	—
Hvy 'Mech Co (IS)	MH	1	3	5	10	—
Assault 'Mech Co (IS)	MA	1	4	4	12	—
Light 'Mech Co (IU)	ML	4	1	8	5	—
Med 'Mech Co (IU)	MM	3	2	7	7	—
Hvy 'Mech Co (IU)	MH	2	4	6	9	—
Assault 'Mech Co (IU)	MA	1	6	4	11	—
<b>Ground Vehicle Units</b>						
Light Vehicle Co	GL	4	2	7	3	—
Med Vehicle Co	GM	3	4	6	5	—
Hvy Vehicle Co	GH	1	6	5	7	—
Assault Vehicle Co	GA	1	8	3	9	—
Supply Convoy	GC	2	0	5	4	—
Ground Trans Co	GT	2	2	6	5	2
Artillery Co	AR	1	4*	3	3	—
<b>VTOL Units</b>						
Attack VTOL Co	VA	5	2	9	4	—
Air Trans Co	VT	4	1	6	4	1
<b>Naval Units</b>						
Naval Trans Co	NT	2	2	5	6	3
Submarine Co	NS	2	6	4	7	—
<b>Infantry Units</b>						
Infantry Bn	IN	1	2	3	7	—
Battle Armor Co (IS)	IB	1	3	4	8	—
<b>Aerospace Fighter Units</b>						
Light Fighter Sqd (IS)	FL	8	2	10	5	—
Med Fighter Sqd (IS)	FM	7	4	9	7	—
Hvy Fighter Sqd (IS)	FH	6	6	8	9	—
Light Fighter Sqd (IU)	FL	8	3	10	4	—
Med Fighter Sqd (IU)	FM	7	5	9	6	—
Hvy Fighter Sqd (IU)	FH	6	7	8	8	—
<b>DropShip Groups (3 DropShips per group)</b>						
DropShip Group (Sm Trans)	DL	6	3	8	10	3
DropShip Group (Med Trans)	DM	5	4	6	11	6
DropShip Group (Lg Trans)	DH	4	6	4	12	9
DropShip Group (Assault)	DA	6	6	6	10	—
<b>JumpShip</b>	JU	0	0	3	8	—
<b>WarShips</b>						
Small WarShip	WM	3	10*	5	13	—
Large WarShip	WH	2	12*	4	14	—
<b>Space Station</b>	SP	0	2	2	10	—
<b>Settlements</b>						
Fortress	T	0	4*	2	14	—
City	C	0	0	2	12	—
Base	B	0	2	2	8	—

\*This unit can attack non-adjacent units. See **Planetary Combat**, p. 84.

### Transport Capacity

A unit with Transport Capacity can carry other units. In the case of ground vehicle units, the Transport Capacity represents how many infantry units the vehicles can carry. DropShips can carry any type of ground or aerospace fighter unit.

### Quality Rating

A unit's Quality Rating represents its skill and experience in battle. As in **BattleForce**, each unit has a Quality Rating of Green, Regular, Veteran or Elite, represented by a skill modifier that applies to combat and other die rolls as necessary (see To-Hit Modifiers Table, p. 86). A unit with no assigned Quality Rating is assumed to be Regular.

# PLANETARY ASSAULT

## UNIT REFERENCE TABLE: CLAN

UNIT TYPE	Counter ID	MP	Attack	Defense	Toughness	Transport
<b>BattleMech Units</b>						
Light 'Mech Binary (C2)	ML	4	1	8	5	—
Med 'Mech Binary (C2)	MM	3	2	7	7	—
Hvy 'Mech Binary (C2)	MH	2	4	6	9	—
Assault 'Mech Binary (C2)	MA	1	6	4	11	—
Light 'Mech Trinary (C2)	ML	4	2	7	6	**
Med 'Mech Trinary (C2)	MM	3	3	6	8	**
Hvy 'Mech Trinary (C2)	MH	2	6	5	10	**
Assault 'Mech Trinary (C2)	MA	1	8	3	12	**
Light 'Mech Binary (C1)	ML	4	2	8	5	—
Med 'Mech Binary (C1)	MM	3	3	7	7	—
Hvy 'Mech Binary (C1)	MH	2	5	6	9	—
Assault 'Mech Binary (C1)	MA	1	7	4	11	—
Light 'Mech Trinary (C1)	ML	4	3	7	6	—
Med 'Mech Trinary (C1)	MM	3	5	6	8	—
Hvy 'Mech Trinary (C1)	MH	2	7	5	10	—
Assault 'Mech Trinary (C1)	MA	1	9	3	12	—
Light Supernova Binary (C1)	ML	4	5	8	6	—
Med Supernova Binary (C1)	MM	3	6	7	8	—
Hvy Supernova Binary (C1)	MH	2	8	6	10	—
Assault Supernova Binary (C1)	MA	1	9	4	12	—
Light Supernova Trinary (C1)	ML	4	7	6	7	**
Med Supernova Trinary (C1)	MM	3	9	5	9	**
Hvy Supernova Trinary (C1)	MH	2	11	4	11	**
Assault Supernova Trinary (C1)	MA	1	13	3	13	**
<b>Ground Vehicle Units</b>						
Supply Convoy	GC	2	0	5	4	—
Ground Trans Binary	GT	2	2	6	5	2
Ground Trans Trinary	GT	2	3	5	6	3**
Artillery Binary	AR	1	4*	3	3	—
Artillery Trinary	AR	1	6*	3	4	**
<b>VTOL Units</b>						
Air Trans Binary	VT	3	1	6	4	1
Air Trans Trinary	VT	3	2	5	5	2**
<b>Naval Units</b>						
Naval Trans Binary	NT	2	2	5	6	3
Naval Trans Trinary	NT	2	3	4	7	5
<b>Infantry</b>						
Infantry Binary	IN	1	2	3	7	—
Infantry Trinary	IN	1	3	3	8	**
Battle Armor Binary (C1)	IB	1	4	4	9	—
Battle Armor Trinary (C1)	IB	1	6	3	10	**
<b>Aerospace Fighter Units</b>						
Light Fighter Star (C2)	FL	8	3	10	4	—
Med Fighter Star (C2)	FM	7	5	9	6	—
Hvy Fighter Star (C2)	FH	6	7	8	8	—
Light Fighter Star (C1)	FL	8	4	10	5	—
Med Fighter Star (C1)	FM	7	6	9	7	—
Hvy Fighter Star (C1)	FH	6	8	8	9	—
<b>DropShip Groups (3 DropShips per group)</b>						
DropShip Group (Sm Trans)	DL	6	3	8	10	3
DropShip Group (Med Trans)	DM	5	4	6	11	6
DropShip Group (Lg Trans)	DH	4	6	4	12	9
DropShip Group (Assault)	DA	6	6	6	10	—
JumpShip	JU	0	0	3	8	—
<b>WarShips</b>						
Small WarShip	WM	3	10*	5	13	—
Large WarShip	WH	2	12*	4	14	—
<b>Space Station</b>						
Space Station	SP	0	2	2	10	—
<b>Settlements</b>						
Fortress	T	0	4*	2	14	—
City	C	0	0	2	12	—
Base	B	0	2	2	8	—

\*This unit can attack non-adjacent units. See **Planetary Combat**, p. 84.

\*\*Trinary units count as two units when being carried by transports and DropShips.

# PLANETARY ASSAULT

## SETTING UP

To begin a game, lay out the two planetary mapsheets on a table or on the floor side by side. Then place settlements of varying types on the mapsheets, as required by the particular scenario being played. Finally, place the battle board off to one side of the main map.

Next, players choose their forces for the scenario. The specific force selection may depend on the scenario being played, or the players may simply use points to purchase forces. Each type of unit has a point value, shown on the Unit Purchase Tables (pp. 89–90). If each player's forces equal the same total points, both sides should have a roughly equal chance of winning the scenario. Specific scenario rules appear in **Planetary Assault Scenarios**, p. 89.

These rules assume that every **Planetary Assault** game involves two sides: either two players or two teams of players. References to a "player" may also mean a team of players, as circumstances dictate.

## SEQUENCE OF PLAY

**Planetary Assault** is played in a series of turns. Each turn represents two days of game time. During a turn, all units on the map may move and attack.

Each turn consists of several phases. During each phase, players can take a specific type of action, such as movement or combat.

The players execute the phases of every turn in a given order. Specific actions, movement, effects of damage and so on are explained in detail further on in this book. Each turn includes the following phases, in the following order:

### SEQUENCE OF PLAY

#### 1. Attacker Phases

- 1a. Movement
- 1b. Combat

#### 2. Defender Phases

- 2a. Movement
- 2b. Combat

#### 3. End Phase

In any given scenario, one player is the attacker and one is the defender. The circumstances of the scenario normally dictate which is which. For example, the attacker usually sets up in DropShips off planet, while the defender sets up on the planet's surface. If the attacker and defender are not clearly assigned, players simply can choose to be the attacker or defender, or roll dice to determine the attacker and defender.

The attacker has the advantage of moving and attacking first because he is the aggressor. The defender has an advantage of his own, however; moving second allows him to react to the attacker's movements and launch effective counterstrikes.

Players repeat the turn sequence until one side meets its victory conditions. Often, the player with the last surviving unit left on the board wins the scenario. If the last units from each side are destroyed simultaneously, the game is a draw. The players may set other victory conditions by mutual agreement before play begins, or by using the **Scenarios** rules on p. 89 or in the FASA scenario pack being played.

## PHASES

Each turn has three phases: the Movement Phase, the Combat Phase and the End Phase. The first two phases—Movement and Combat—are played by the attacking player first, then by the defending player. The attacking player resolves both of his phases before the defending player begins resolving his.

### Movement Phase

The player moves any or all of his units, one at a time.

### Combat Phase

The player resolves combats in which his units are involved, one at a time.

### End Phase

During the End Phase, players execute any miscellaneous actions remaining in the turn.

## CONTROL

A key factor in a successful planetary campaign is control of military bases and population centers. At the start of the campaign, the defenders have control of the planet and can keep their troops supplied more easily than the enemy can because locals are willing to support them. Access to supplies can often mean the difference between victory and defeat.

When ground units from only one side occupy a hex (or naval units in the case of Ocean hexes), that side is said to control that hex. This section describes how to determine who has control of what areas of the planet in other circumstances.

Air and aerospace units cannot control a hex.

### DEFAULT CONTROL

Default control of hexes depends on the spread of a world's population. Population spread is determined by the world's general type: Major, Minor or Unpopulated.

Ocean hexes (hexes containing only water) and Arctic hexes are the exceptions to this rule. Ocean hexes are presumed neutral unless occupied by one or more naval units, and Arctic hexes are presumed neutral unless occupied by one or more ground units.

The city hex and all six surrounding hexes are considered to be under the control of the player who controls the city (normally the defender, unless defined otherwise by the scenario rules, or unless the attacker occupies the city; see **Seizing Control**, below).

### Major World

A Major World is heavily populated, with settlements of some kind over its entire surface. Examples of such worlds include Terra and the capitals of most of the Inner Sphere's Successor States (New Avalon, Luthien, Sian and so on).

Unless occupied by enemy forces, every land hex on a Major World map is assumed to be controlled by the defending side. The attacker must take control of a hex by moving into it. Thereafter, the attacker can only maintain control by keeping at least one attacking unit or base in the hex. The defending side automatically regains control of a hex if the attacker does not occupy it.



# PLANETARY ASSAULT

## Minor World

Most worlds in the Inner Sphere and Periphery are sparsely populated compared to modern-day Earth. Even though they may have large populations, those populations are normally concentrated around a limited number of cities. If the rules of a particular scenario do not establish any other default control conditions, assume that the planet where the battle is being fought is a Minor World.

On a Minor World, all hexes are considered neutral unless they contain a city or are adjacent to one. All other hexes are neutral unless one side or the other occupies them during the scenario.

## Unpopulated World

If a world has no native defender in a scenario—for example, in a war that pits two sides against each other on a neutral planet—then the world is assumed to be unpopulated. All hexes are considered neutral, and will revert to neutral status unless one side or the other occupies them during the scenario.

## SEIZING CONTROL

In order to seize control of a hex, a player must occupy that hex with one or more of his ground units. As long as no enemy ground units are occupying that hex, the player retains control of the hex at the end of the turn.

Taking control of hexes containing settlements is a bit more difficult to accomplish, as described below.

## Cities

Cities are difficult to control because the native population usually resists being conquered. To reflect this, an attacker taking control of a city must spend a turn pacifying it before he can claim to control it. In the End Phase of the turn in which the attacker takes the city, flip the city counter over to its Rubble side to indicate that the city is undergoing civil unrest. At this point, neither side controls it. In the End Phase of the following turn, if the city's hex is occupied only by attacking ground units, the counter is flipped back over to show that the attacker controls it. If the city's hex is unoccupied or occupied by defending units, the counter is likewise flipped over, but control reverts to the defender.

When a player seizes control of a city, he also assumes control of the six hexes surrounding it, except for Ocean or Arctic hexes (if any).

A conquered city stays under the attacking player's control only as long as at least one attacking ground unit is in the city's hex during the End Phase. Players should consult the City Status Table below during each End Phase to determine the status of each city in question. Flip the City counter to the Rubble side only on the turn in which the hex is first occupied by the attacking player.

## Bases and Fortresses

Bases and fortresses are manned by soldiers and so cannot simply be pacified like cities. Instead, the attacker must defeat them in combat. The controlling player uses these settle-

## CITY STATUS TABLE

Forces Present	City	Rubble (Unrest, no Control)
Occupied by Attacking Ground Unit(s)	Flip over to Rubble side	Flip over to City side; Attacker Control
Occupied by Defending Ground Unit(s)	Defender Control	Flip over to City side; Defender Control
Unoccupied	Defender Control	Flip over to City side; Defender Control

ments to defend against attack in the same way as other combat units (see **Planetary Combat**, p. 84). Once the settlement is defeated, its counter is flipped over to the Rubble side to indicate that the attacker is in the process of capturing it. In the following turn's End Phase, check the status of the fortress or base as if it was a city. A base or fortress flipped to its Rubble side comes under the control of whichever side occupies its hex in the End Phase. The controlling player may then opt to destroy the settlement rather than using it, in which case its counter is removed from play. If no one occupies the base or fortress, it stays Rubble until someone does, and is considered neutral ground.

Because bases and fortresses are re-staffed by soldiers loyal to the attacker once captured, they do not automatically revert to the defender's control when unoccupied. To reflect this, once a base or fortress is captured, replace its counter with one belonging to the capturing player. This will make it easier for players to keep track of who controls each fortress or base. If there aren't enough counters of the appropriate color, use an objective counter, coin or other appropriate marker to indicate control.

## SUPPLY

Keeping troops supplied in the field is essential to their functioning. Ammunition, spare parts, food and other supplies must continually be brought to the front lines or the performance of the troops will suffer. Units can only fight at maximum effectiveness if they are supplied.

In the game, a unit is considered supplied if a friendly settlement (base, city or fortress) is adjacent to or in the same hex as the unit. The range of supply can also be extended through hexes controlled by the unit's player (see **Control**, p. 77). As long as an uninterrupted string of friendly hexes exists between a unit and a settlement controlled by the same player, the unit is supplied. Otherwise, the unit is said to be out of supply. If a unit is out of supply, it fights at reduced efficiency, as noted in the Combat Modifiers Tables (p. 86).

## SIEGE

Units in the same hex as a settlement are always considered supplied unless the settlement is under siege by the enemy, meaning that it is completely surrounded by enemy units. If all six hexes adjacent to the settlement contain enemy units (even if some of those hexes also contain friendly units), the settlement is under siege. Units in the same hex as that settlement are considered out of supply until the siege is broken.

If any supply convoys (see below) are in the same hex as settlement, the controlling player can use them to temporarily counter the effects of the siege. When combat starts, spend

# PLANETARY ASSAULT



one supply convoy; all other units in the hex are then considered supplied for the duration of the fight.

## SUPPLY CONVOYS

Supply convoys are special ground units vital to maintaining supply lines, and can perform field repairs on damaged units during combat. Unlike other unit types, supply convoys can be created and can switch sides during game play. This allows a player to capture his opponent's supplies and use them against him.

### Creating Convoys

Each player may create one new supply convoy per turn. He may place this newly created convoy in any hex containing a friendly base, fortress, city or DropShip. In addition, if a player controls one or more cities, he may create one additional convoy, which must be deployed in a city.

These new units are placed on the map in the End Phase of the turn in which they were created. New supply convoys cannot enter play in a settlement that is under siege. Any convoys that cannot be placed on the map because of siege conditions or a shortage of DropShips or settlements are lost.

### Convoy Uses

A supply convoy can perform several useful tasks. The most common, and the only use that does not consume them, is maintaining a supply line. Like other units, a supply convoy

can control a hex and therefore maintain a line of supply, freeing up combat units for battle.

Two convoys together in a hex can create a base in that hex during the End Phase of a turn. A player who wishes to do this should remove both convoys from play and replace them with a single base counter.

Supply convoys can make field repairs during combat. A supply convoy in a box with a damaged unit may repair that unit. After the unit is repaired and its counter flipped face-up, the convoy is considered consumed and removed from play. For more on combat, see p. 84.

### Capturing Convoys

Supply convoys are non-combat units and so never take part in battle. If one or more convoys are alone in a hex with enemy ground units during the End Phase of a turn, they are automatically captured by the enemy. The enemy can replace the convoy counters with his own counters to indicate the shift in control. Air units cannot capture convoys.

## SUPPLY IN SPACE

Fighter units in space must be in an orbit zone or hex on the System Diagram with a friendly JumpShip, WarShip, DropShip or space station to be considered supplied. Supply lines do not exist in space.

# PLANETARY ASSAULT

## PLANETARY MOVEMENT

In **Planetary Assault**, the following basic movement rules apply only to ground-based units, including naval and VTOL units. Aerospace units such as fighters and DropShips use different rules (see **Aerospace Movement**, p. 81). As in **BattleForce**, each player may move any or all of his units during his Movement Phase.

Each turn of game play represents roughly two days. Though some units may move across the map faster or slower than would be possible at this time scale, we chose to emphasize the overall feel of the game over rigid adherence to unit speeds, time and distance conventions from **BattleTech**.

Stacking limits do not apply in **Planetary Assault**. Any number of units may occupy a single hex.

### MOVEMENT COSTS

Units move according to their Movement Point (MP) allowance. Each unit's MP is listed on the Unit Reference Tables (**Planetary Assault**, p. 75). Each hex costs a certain number of MP to enter, based on its terrain type as shown on the Planetary Terrain Table. Units may move in any desired direction; they have no facing while moving on the main game map.

A unit may always move 1 hex as its only movement for a turn, even if entering the hex costs more than the unit's MP. This rule does not allow a unit to enter prohibited terrain, however.

A ground unit entering a hex occupied by one or more enemy units must end its move in that hex. It can enter the hex, but cannot move through it. Air units (including aerospace and VTOL units) can move through any desired hexes without restriction.

#### PLANETARY TERRAIN TABLE

Terrain Type	MP Cost	Prohibited Units
Plains	1	Naval*
Woods	2 (3)	Naval*
Mountains	3 (4)	Naval*
Desert	2	Naval*
Arctic	2	Naval*
Water	1	BattleMech, Ground Vehicle, Infantry**

Aerospace and VTOL units pay 1 MP per hex regardless of terrain. The MP cost in parentheses applies to ground vehicle units only (see **Unit Reference Tables**, p. 75).

\* Naval units can occupy these hexes as long as there is some water in the hex.

\*\* Ground units can occupy these hexes as long as there is some land in the hex.

### CROSSING WATER HEXES

Water hexes, represented on the map by the color blue, come in a variety of types depending on the amount of water in the hex and how it is arranged relative to the land in the same hex (if any). Ocean hexes, which are filled with water, are off-

limits to ground units. Only naval, aerospace and VTOL units can enter them.

Hexes with some water in them, which represent inlets, lakes or rivers, can be crossed in certain circumstances. Both ground and naval units can occupy these hexes. A ground unit can move from one such hex to another if there is land across an adjacent hexside. Likewise, naval units can move from Water hex to Water hex as long as there is water across an adjacent hexside.

Some hexes contain two distinct areas of land divided by water (such as Hex G18 on the map of Terra). These divisions cannot be crossed during the course of a move. However, if a unit starts its move in such a hex, it can move in either direction to begin its movement, because the ground unit is considered to occupy all of the land in the hex. Players need not indicate which coast, island, or body of water in a hex a unit occupies. The same rule applies in reverse to naval units moving through water, when a hex has two distinct areas of water divided by land (such as Hex G20 on the map of Terra). The example below illustrates this principle.

For hexes containing multiple islands, such as Hawaii, consider all the islands in the hex as a single land mass. Players need not distinguish which units are on which islands. Small islands next to large land masses, such as Ireland, are simply considered part of the larger land mass to which they are adjacent.

Canal hexes can be crossed as though they were land or water, unless specifically forbidden by the scenario rules.

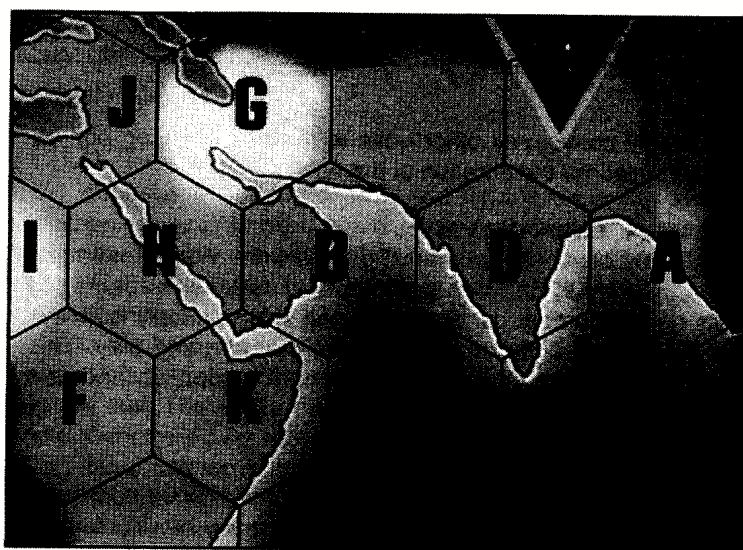

The diagram above illustrates how water can block movement for units moving through eastern Africa and southern Asia. Units A and B are ground units. Unit C is a naval unit.

A naval unit with 2 MP in Hex A cannot move directly to Hex B, because the land in Hex D blocks the movement through it. In order to reach Hex B, the unit would have to first enter Hex C, then Hex D or E, before arriving in Hex B. If the naval unit began its Movement Phase in Hex D, it could spend 1 MP and move directly to Hex A, B, C or E.

A ground unit with 2 MP in Hex F cannot move directly to Hex G, since the water in Hex H blocks the

TECH

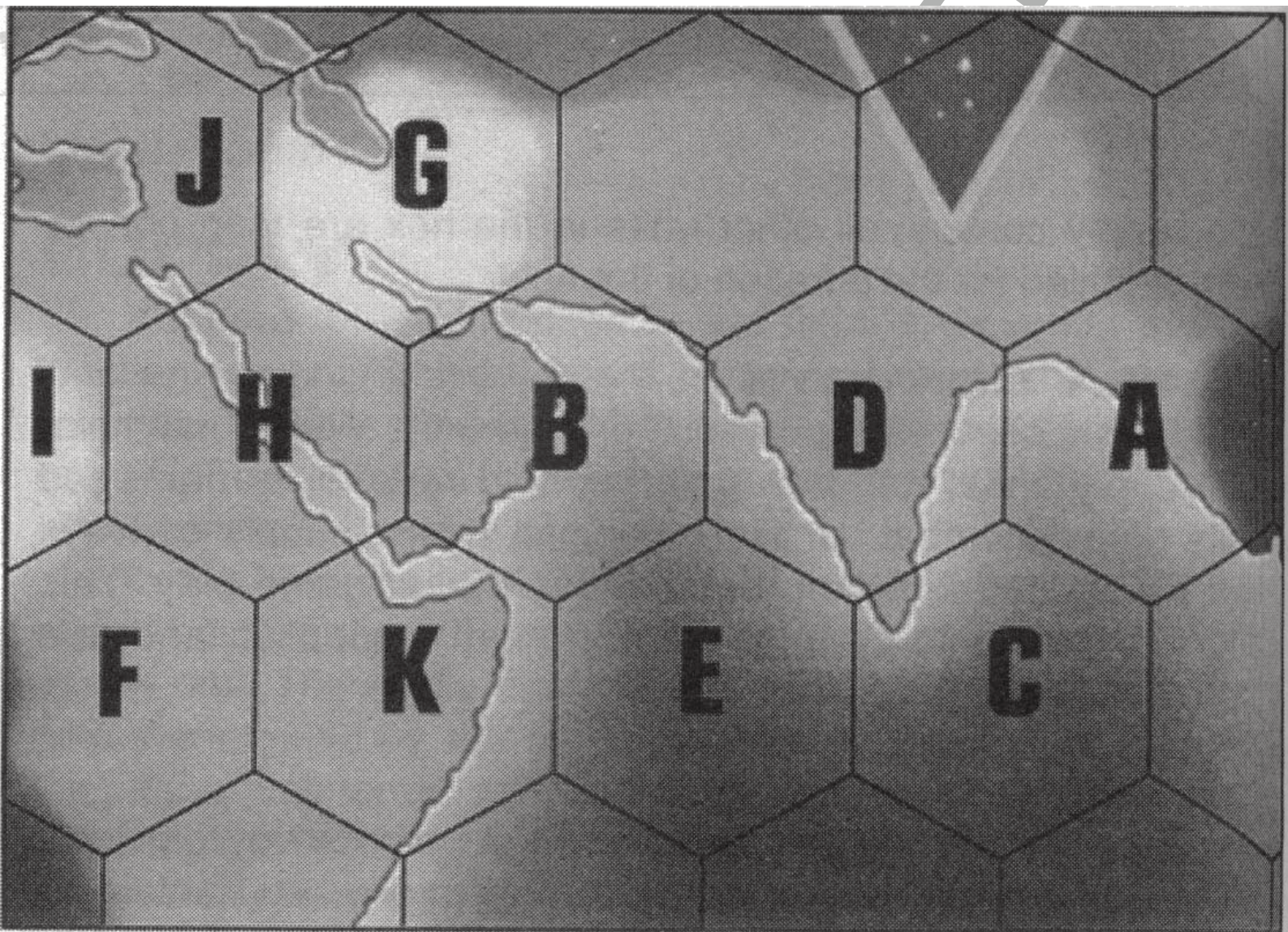

РУССКА

# PLANETARY ASSAULT

*movement through it. In order to reach Hex G, the unit would have to first enter Hex H or I, then move into Hex J, before arriving in Hex G. If the ground unit began its Movement Phase in Hex H, it could spend 1 MP and move directly to Hex F, G, I, J or K.*

## BOARD/DISEMBARK TRANSPORT

Ground units can be transported over short distances by transport vehicles, over long distances by DropShips and over water by naval units. Collectively, these vehicles and vessels are referred to as transports.

Each type of transport unit has a limited carrying capacity, as shown on the Unit Reference Tables (p. 75). This number represents the maximum number of units it can carry at any one time. Transports may not carry other transports, with the exception of naval transports and DropShips; these vessels may carry loaded transport vehicles up to the vessels' Transport Capacity (but may not carry other naval transports or DropShips). Units inside the smaller transports being carried do not count against the larger transport's carrying capacity. No type of transport can carry large space craft such as JumpShips, WarShips and space stations.

During a player's Movement Phase, any ground unit in the same hex as a transport may board that transport instead of making a normal move. The transport may pick up units at the beginning of or during its move. Once the transport unloads one or more of the units it is carrying, its movement for the turn ends unless it is executing a combat drop (see below). Disembarking from a transport does not count as movement for carried units; this means that, unless they are disembarking in the same turn in which they boarded the transport, the units can move immediately after disembarking.

Any units a transport is carrying are destroyed if the transport is destroyed. For this reason, most transport units unload all units they are carrying at the beginning of any combat.

## Movement and Combat Drops

A DropShip unit can unload troops while moving or hovering over the battlefield, dropping them in the enemy's midst. This bold and dangerous tactic, known as a combat drop, is the only way a transport unit can continue to move after unloading carried units. A single DropShip unit may only make one combat drop per turn.

Only BattleMech and battle-armor units can be dropped. Other unit types must disembark normally.

The transport DropShip unit can either stay in the hex and execute the drop during combat or drop the units and continue to move. In the latter case, the controlling player places the counters of the units to be dropped in the target hex and then finishes the DropShip unit's movement. He resolves possible damage to the dropped units at the beginning of his Combat Phase. If the DropShip unit stays in the hex with the dropping units, resolve damage to the dropping units or to the DropShip unit during the Combat Phase.

A combat drop can also be performed over a hex containing no enemy units. Because no combat takes place in such a situation, the player resolves the drop in his Movement Phase instead of in the Combat Phase. Roll 2D6 for each dropping unit. If the result is equal to or greater than the unit's Toughness Rating, roll 2D6 again. If the result of the second die

roll is also equal to or greater than the unit's Toughness Rating, the unit is destroyed.

Units may not move after they have been dropped. For more information on combat drops, see **Combat**, p. 84.

## RECONNAISSANCE

Even with advance intelligence reports, neither side can know the exact identity of enemy units until an accurate reconnaissance (recon) is made of enemy positions. Attacking enemy units before making a recon is a good way to lose troops.

To represent this limited knowledge of the enemy, all unit counters are kept face-down until "reconned" by the other side. By contrast, counters representing supply convoys and settlements (cities, fortresses and bases) are face-up, except in certain circumstances not related to reconnaissance (see **Control**, p. 77).

A unit may only make one recon attempt against one adjacent hex per turn, at the end of the unit's movement. Each recon attempt costs 1 MP per face-down enemy unit that the reconning player wishes to identify in the target hex. This means that units with only 1 MP cannot move if they wish to recon.

To determine if the recon attempt succeeded, roll 2D6 and compare the result to the reconning unit's Defense Rating. If the result is equal to or less than the Defense Rating, the counters for the chosen units are flipped face-up. If the result is higher than the unit's Defense Rating, the reconning unit's counter is flipped face-up.

## AEROSPACE MOVEMENT

In **Planetary Assault**, aerospace units are those that can fly through the atmosphere as well as in space: aerospace fighter and DropShip units.

JumpShips, WarShips and space stations are special cases. These units cannot fly through the atmosphere, and so cannot enter the planetary surface map. Otherwise, they move like fighters and DropShips except as noted below.

## ATMOSPHERIC FLIGHT

Aerospace fighter and DropShip units can move on the planetary surface map. Because planetary terrain restrictions do not apply to these units, they are easier to move than ground or naval units. Aerospace units can move up to their MP rating in hexes each turn.

Unlike other types of units, aerospace units can make a single attack during movement (see **Aerospace Combat**, p. 87).

Aerospace units on the planetary surface map may enter orbit instead of making a normal move. See **Entering Orbit**, p. 82.

## PLANETARY ORBIT

Fighters, DropShips, space stations and WarShips can all enter planetary orbit and fight each other in near space. WarShips can even engage in orbital bombardment, launching attacks from orbit against ground targets.

The map shows ten orbit zones around the planet. Ships in orbit occupy one of these orbit zones, each of which corresponds to a diamond-shaped area on the planetary map (bordered by a dotted line connected to the planetary map by a solid line; see the diagram on p. 82). Only units occupying the same orbit zone may fight one another, and WarShips may only bombard the planetary area that corresponds to the orbit zone they occupy.

# PLANETARY ASSAULT

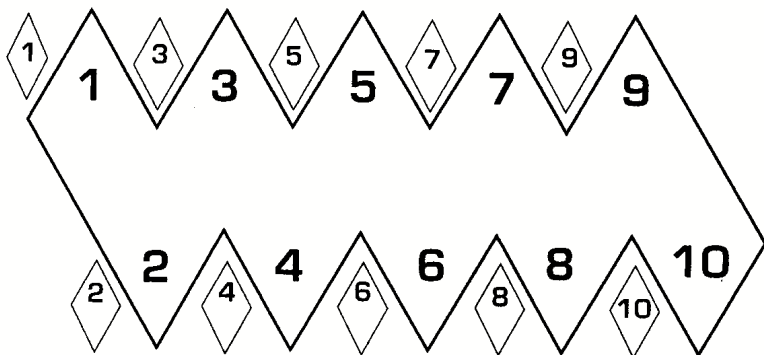

Hexes that contain a border between two or three orbit zones are considered to be beneath all corresponding orbit zones.

## Orbital Movement

Each unit in orbit can move from orbit zone to adjacent orbit zone, making a number of moves up to its MP. The orbit zones are numbered from 1 to 10; Orbit Zone 10 is adjacent to Orbit Zone 1. Units move through these zones in numerical order, switching from 10 to 1 or 1 to 10 when leaving the edge of the map.

Ships carrying fighters can launch or recover them, in the same way that ground units board and disembark from transports on the ground (see p. 81).

A DropShip carrying BattleMech or battle-armor troops may drop them from orbit into any hex in the section of the planet map that corresponds to the orbit zone occupied by the DropShip. This type of combat drop works the same way as other combat drops, except add a +2 modifier to the dice roll results when resolving possible damage from the drop.

## Entering Orbit

Depending on the scenario setup, units may begin play in orbit. Space stations usually start play in orbit, though they are sometimes found in deep space, most often at zenith or nadir points. Other units must enter orbit from either the planetary surface or deep space.

Fighters and DropShips on the planetary surface may enter orbit instead of making normal movements for the turn. To indicate this, simply move the unit from the planetary surface to the corresponding orbital zone.

Fighters, DropShips and WarShips in deep space may enter orbit only if they occupy the hex on the System Diagram that contains the planet at the beginning of the Movement Phase. In this case, instead of moving on the System Diagram, the unit may enter the planetary map. Move the unit counter into the orbit zone desired.

## Leaving Orbit

Instead of making a standard move, an orbiting unit can choose to leave planetary orbit and enter deep space. To indicate this, simply move the unit's counter to the hex on the System Diagram that contains the planet. In the following turn, the unit moves normally on the System Diagram (see **Deep Space Movement**, below).

## Landing

Instead of moving, an orbiting fighter or DropShip unit can choose to attempt a landing. The player must nominate a target hex for the landing, which can be any desired land hex in the planetary surface region corresponding to the orbit zone occupied by the unit at the end of its movement.

The player then rolls 2D6 to see if the atmospheric entry and landing succeeded. The Base Target Number for this roll is 4, modified by the skill of the DropShip crew. The target number is further modified by +2 for each of the following conditions existing in the target hex: it contains an enemy city or fortress, is adjacent to an enemy city or it contains an enemy aerospace unit. Each of these modifiers is cumulative. For example, a hex containing an enemy fortress and two enemy fighter units that is also adjacent to an enemy city would impose a total modifier of +8 to the target number. Not a very good place to land!

If the landing roll result is equal to or greater than the modified target number, or is a 12, the landing is successful. After a successful landing, place the unit in the designated landing hex. On a result of 2, or a result less than the modified target number, the landing fails and the unit stays in the orbit zone. After a failed landing attempt, roll 2D6 again. If the second die roll result is a 2, the unit is destroyed.

A DropShip unit landing in an enemy-occupied hex can also execute a combat drop if it is carrying 'Mech and/or battle-armor units, assuming the landing is successful. Rules for combat drops appear in the **Combat** section under **Combat Drops**, p. 84.

## DEEP SPACE MOVEMENT

Some scenarios require units to approach the battlefield from jump points or other areas of deep space, often as reinforcements. In some scenarios, the game starts with the attackers arriving at jump points. Movement from jump points to the planet takes place on the System Diagram, on the right-hand side of the planetary surface map.

Even though they carry DropShips, JumpShips and WarShips have no Transport Capacity because they do not carry units in the same way as other transports. Unless otherwise specified by the scenario, each JumpShip or WarShip unit can carry up to two DropShip units. The DropShip units embark and disembark from JumpShips and WarShips using the same rules for disembarking as other units (see **Board/Disembark Transport**, p. 81).

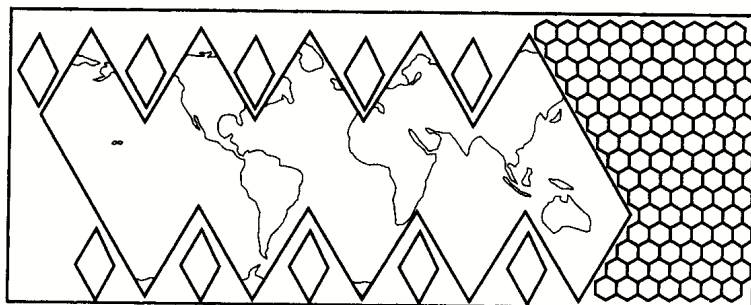

## System Movement

DropShips and WarShips can move 1 or 2 hexes per turn on the System Diagram. Fighter units may only move 1 hex per turn because they do not carry enough fuel to make quick sys-

# PLANETARY ASSAULT



tem transits possible. Other space units (JumpShips and space stations) do not move.

As with orbital movement (p. 82), ships carrying fighters can launch or recover them.

## Entering the System Diagram

Ships enter the System Diagram either by leaving orbit as described above or by jumping in-system on a JumpShip.

The scenario being played will establish the point at which arriving JumpShips should be placed on the map. JumpShips and WarShips entering the system can be placed at the zenith or nadir jump point (marked "Z" and "N", respectively, on the map). If the player desires, he can use a pirate point instead of the standard jump points (marked "P" on the map).

Hyperspace travel is a risky business, and doesn't always succeed. To reflect this, players must roll 2D6 against the target number shown in the desired arrival hex. If the result of the dice roll is less than the target number, the jump is off-target. The ship arrives in the following turn at either the zenith or nadir jump point, whichever is closer to the intended arrival point.

Ships jumping in-system enter the System Diagram at the end of the controlling player's Movement Phase, and cannot move or make attacks for the remainder of the turn. However, they can defend themselves and counterattack per standard rules.

## Leaving the System Diagram

Ships occupying the appropriate planet hex at the start of their controller's Movement Phase can enter orbit in any desired orbit zone.

JumpShips and WarShips with charged jump drives or a charged lithium-fusion battery can leave the System Diagram if they occupy the zenith or nadir jump point at the beginning of their controller's Movement Phase. Such vessels are removed from play, and cannot return unless they recharge their batteries.

Charging jump drives and L-F batteries takes a variable amount of time based on the size of the star in the system. If this data is not provided by the scenario being played, recharging takes  $1D6 + 1$  turns, during which time the charging unit may not move. The unit may engage in combat, but a unit attacked while charging is more vulnerable to damage because its fragile jump sail is deployed. To reflect this, reduce the unit's Toughness Rating by 2 while it is charging. The charging unit may not move while on the battle board, and must be deployed in the controlling player's main box (see **Planetary Combat**, p. 84).

Unless players are using **BattleSpace** statistics for specific ships that state otherwise, assume that only WarShips have L-F batteries. An L-F battery allows a WarShip to make one extra jump before it must be recharged.

# PLANETARY ASSAULT

## PLANETARY COMBAT

After both side's forces have landed on the planet and completed their strategic maneuvering, the two sides clash in combat. Once enemy units meet in a hex, players can quickly work out the results using the battle board and the following movement and combat rules. For more detailed combat resolution, players can translate their units to **BattleForce** scale and play out the combat using **BattleForce** rules (see **Integration**, p. 104).

### THE BATTLE BOARD

Combat in **Planetary Assault** is resolved on the battle board. Units are transferred to the battle board for the duration of the combat, then replaced on the planetary map.

The battle board is divided into twenty-five boxes. Each box represents a position on the field rather than a specific real-world distance. During play, the battle board is placed so that one of the board's long sides faces each player.

Reserve	Reserve	Reserve	Reserve	Reserve
Right	Right	Main	Left	Left
Left	Left	Main	Right	Right
Reserve	Reserve	Reserve	Reserve	Reserve

### TERRAIN

The nine shaded boxes in the center of the battle board represent the terrain of the hex in which the battle is being fought. The other boxes represent outlying terrain, which is determined by the shaded terrain as shown on the Battle Board Terrain Table.

In the case of coastal hexes or other hexes that combine water and land, the battle takes place on land or water depending on the units involved. Combat solely between air and naval units takes place over water. If opposing naval and land units both occupy the hex, the players must fight two separate battles: one on land involving land and air units, and one at sea involving naval and air units. Air units in the hex can only participate in one or the other conflict; the controlling player must assign those units to the battle in which they will take part before either combat is resolved.

### DEPLOYMENT ZONES

The ten boxes on the side of the battle board nearest to each player represent his deployment zone. The five boxes closest to the edge of the battle board (the long side nearest the player) are called the reserve area. The front-and-center box is the player's main box, and serves as the center of each player's battle lines during setup.

### BATTLE BOARD TERRAIN TABLE

<b>Shaded Terrain</b>	<b>Outlying Terrain</b>
Arctic	Arctic
Desert	Desert
Woods	Plains
Mountains	Woods
Plains	Plains
Space	Space
Water	Water
<i>Island Hex</i>	
Primary*	Water
<i>Lake Hex</i>	
Water	Primary*

\*For Island and Lake hexes, the primary terrain feature is whatever non-water terrain is in the hex. For example, if the land in an Island hex is wooded, then the shaded boxes are considered Woods terrain, surrounded by water. If the land surrounding a lake is wooded, then the outlying terrain is Woods.

### SETUP

Any building present in the hex in which combat occurs must be placed first by the building's controlling player anywhere in his deployment zone. Buildings do not count as units for stacking purposes, and friendly units in the same box as a building are assumed to be inside that building.

Which player sets up units first depends on each side's intelligence information. If only one player had face-down units (units that had not been revealed by reconnaissance) on the planetary hex where the battle is taking place before combat began, then the player with no face-down units must set up first. If both players had some face-down units, the attacker sets up his face-up units first, followed by the defender's face-up units. Then the attacker sets up his face-down units, followed by the defender. If neither side had any face-down units, the attacker sets up all his units first. Each side sets up as follows.

Each player must place at least one unit in his main box. Then he places one unit in each of the remaining boxes in his deployment zone. If the player has more than ten units in the battle, he may place one additional unit in each box, beginning with his reserve boxes and then his front-line boxes. If a player has more than twenty units to deploy, he may place a third additional unit in each box, and so on.

Once setup is finished, all unit counters on both sides of the battle board are flipped face-up. Their recon status only matters before battle. During battle, counters are turned face-up or face-down to reflect each unit's damage status.

### COMBAT DROPS

A player whose DropShips are carrying BattleMech and/or battle-armor units to the battle site, or who dropped such units into the battle hex during his Movement Phase (see **Movement and Combat Drops**, p. 81), can place the units anywhere on the battle board. All dropped units must be placed in the same



# PLANETARY ASSAULT

box, and cannot be placed in a box containing enemy units. Dropped units are placed after players have set up all other units. The transport from which they were dropped is then placed anywhere in the controlling player's reserve area.

To determine whether a dropped unit takes damage, follow the rules given in **Movement and Combat Drops**, p. 81.

## COMBAT SEQUENCE

After setup, combat proceeds in a series of Combat Turns.

Beginning with the attacker, each player takes turns executing up to two actions with his units: moving or attacking. Supply convoys can also perform repairs, a special action. Regardless of the number of units on each side, each player may take no more than two actions per Combat Turn. Players may take only one action or no action if they so desire.

Players may take their actions in any order: move and attack, attack and move, two attacks or two moves. A player may split his actions between two different units, or a single unit may execute both. However, the same unit cannot perform two actions of the same type in the same Combat Turn.

## MOVEMENT

One ground unit may move a number of boxes up to its MP. It may move only to one of the four boxes adjacent to it; a unit may not move diagonally. Terrain affects movement on the battle board, just as it does on the planetary surface map (see Planetary Terrain Table, p. 84).

Any number of friendly units may occupy each box into which the unit moves. A unit may not move into or through enemy-occupied boxes. Units that move off their home board edge are out of the battle.

Air units do not pay MP to move because terrain does not affect them. They can move through enemy-occupied boxes, but may not end a move in one.

## Facing

Units have facings on the battle board, but a moving unit need not change its facing to move backward or sideways. Maintain the unit's initial facing as it moves. A player may change a unit's facing, at a cost of 1 MP. Rotate the unit's counter to any facing desired.

## ATTACKS

In a turn, a player may have one of his units attack one adjacent enemy unit. The target unit must be in the box in front of the attacker or in one of the boxes to the attacker's side; units cannot attack to the rear. Artillery and WarShip units may attack a unit up to 3 boxes away in any direction except diagonally. For rules on resolving attacks, see **Attack Resolution**, below.

Units being carried in transports cannot attack or otherwise take part in combat.

## REPAIRS

This special action is only available to supply convoys. To make repairs, the supply convoy must be in the same box as a damaged friendly unit. The controlling player spends an action and removes the supply convoy from play; the damaged unit is then considered repaired and its counter is flipped face-up.

## ATTACK RESOLUTION

When resolving an attack, players first roll to see if the attack hit. Then the attacker makes a second dice roll to see if the attack damaged or destroyed the target unit.

### TO-HIT ROLL

To determine whether an attack hit its target, the attacker rolls 2D6 against a base target number equal to the target unit's Defense Rating. Modify this target number as appropriate for the terrain in the target box, the attacker's skill and position, and friendly support available for both sides. The To-Hit Modifiers Table lists modifiers for various conditions; specific modifiers are explained below.

A die roll result of 2 automatically misses, and a result of 12 automatically hits.

### Quality Rating

If the attacking unit has a Quality Rating other than Regular, apply the appropriate skill modifier to the target number.

### Out of Supply

The supply rules (p. 79) define how to determine whether or not a unit is supplied. If units on one side or the other were supplied on the planetary map, they are also considered supplied on the battle board, regardless of the position of buildings, supply convoys or other units on the board.

An attacking unit out of supply suffers a +2 modifier to the target number. If the target unit is out of supply, modify the target number by -1.

### Damaged

If the attacking unit is damaged (indicated by a face-down counter), modify the target number by +2. If the target is damaged, modify the target number by -2.

### Position

The attacker's position relative to the target affects battle directly because the target unit's facing indicates how it is deployed for combat. If a unit is attacked from the flank or rear, it is unprepared for the attack and therefore makes an easier target.

If the attacker is on the target's flank, modify the target number by -1. If the attacker is behind the target, modify the target number by -2.

Position modifiers only apply to targets that have a facing. Infantry, settlements and supply convoys have no facings, and so these modifiers do not apply to them.

### Harassment

In **Planetary Assault**, each attack is not a single volley of weapons fire, but rather represents a series of skirmishes. If units friendly to the attacking unit are nearby, those units will aid in the attack, either by attacking the target themselves or by restricting the target's mobility and avenues of retreat. Units friendly to the target unit can aid it likewise.

For each enemy unit adjacent to the attacking unit, not counting the target, modify the to-hit number by +1. For each unit friendly to the attacker that is adjacent to the target, not counting the attacker, modify the to-hit number by -1.

# PLANETARY ASSAULT

## Terrain

Terrain in the target's box can offer the target protection from attacks. Modifiers for each type of terrain are listed on the To-Hit Modifiers Table. Remember that the shaded central boxes on the battle board often have different terrain than the outer boxes, as shown on the Battle Board Terrain Table (p. 84).

Air units do not benefit from terrain, though the targets of their attacks do. Infantry units are especially good at hiding in certain types of terrain, and so they gain double the listed terrain modifier. However, they also double the value of negative terrain modifiers, such as those for Arctic or Desert hexes. This penalty reflects the fact that infantry units caught in such open terrain are that much more vulnerable than other, tougher types of units.

## TO-HIT MODIFIERS TABLE

Condition	Modifier
<i>Attacker</i>	
Quality Rating	
Green	+1
Regular	+0
Veteran	-1
Elite	-2
Out of Supply	+2
Damaged	+2
On Target's Flank	-1
On Target's Rear	-2
Harassed (enemy units adjacent to attacker)	+1 per unit
<i>Target</i>	
Damaged	-2
Out of Supply	-1
Harassed (enemy units adjacent to target)	-1 per unit
<i>Target's Terrain*</i>	
Arctic	-1
Base	+1
City	+2
Plains	+0
Desert	-1
Forest/Jungle	+2
Fortress	+3
Mountains	+3
Water	-2

\*Double these modifiers for infantry units, whether the result is good or bad for the unit. Terrain modifiers are not cumulative; use the single highest applicable modifier only.

## DAMAGE ROLL

If the attack succeeds, the attacker must make a 2D6 Damage Roll against the target unit's Toughness Rating to actually damage the target. Add the attacker's Attack Rating and apply other appropriate modifiers shown on the Damage Roll Modifiers Table to the roll result. The types of modifiers

that may be applied are the same as those for the to-hit roll, though the actual numbers may vary. The target number remains the target's Toughness Rating, unmodified.

If the total modified Damage Roll result is equal to or greater than the target number, the target unit is damaged. To indicate this, flip the unit counter face-down. If the target was already damaged, additional damage destroys it. A unit is also destroyed if the total modified Damage Roll result is double or more the unit's Toughness Rating.

An unmodified result of 2 automatically fails to damage the target. An unmodified result of 12 automatically damages the target.

## Out of Supply

If the attacking unit is out of supply, apply a -2 modifier to the Damage Roll. If the target unit is out of supply, modify the Damage Roll by +1.

## Damaged

If the attacking unit is damaged, modify the Damage Roll by -2. If the target is damaged, modify the Damage Roll by +2.

## Position

If the attacker is on the target's flank, modify the Damage Roll by +2. If the attacker is behind the target, modify the Damage Roll by +4.

## Harassment

For each enemy unit adjacent to the attacking unit, not counting the target, modify the Damage Roll by -1. For each unit friendly to the attacker that is adjacent to the target, not counting the attacker, modify the Damage Roll by +1.

## Terrain

BattleMechs have an advantage over other combat units because they can increase the intensity and frequency of their

## DAMAGE ROLL MODIFIERS TABLE

Condition	Modifier
<i>Attacker</i>	
Attack Rating	+Rating
Out of Supply	-2
Damaged	-2
On Target's Flank	+2
On Target's Rear	+4
Harassed (enemy units adjacent to attacker)	-1 per unit
Arctic Terrain*	+1
Desert Terrain*	-1
<i>Target</i>	
Damaged	+2
Out of Supply	+1
Harassed (enemy units adjacent to target)	+1 per unit

\*This modifier applies to BattleMechs only.

# PLANETARY ASSAULT

attacks at will. However, such activity builds up tremendous amounts of waste heat that can endanger the 'Mech. In conditions of extreme heat or cold, a 'Mech must manage its heat differently than usual, which may be an advantage or a disadvantage when inflicting damage.

In Arctic terrain, a 'Mech unit can attack more frequently than normal; apply a +1 modifier to the Damage Roll result. In Desert terrain, a 'Mech unit must attack less frequently to avoid overheating; apply a -1 modifier to the Damage Roll result.



The above diagram illustrates a combat situation on the battle board. The combat is taking place in a Woods hex, and so the predominant terrain (in the shaded boxes) is Woods/Jungle and the outlying terrain is Plains. Unit A is an Inner Sphere assault 'Mech unit. Unit B is a medium front-line Clan 'Mech unit, while Units C and D are light front-line Clan 'Mech units. All have Regular Quality Ratings, are undamaged and are supplied.

Unit A can attack either Unit B or Unit C. It cannot attack Unit D, because Unit D is behind it and units cannot attack to the rear. Because Unit B has a lower Defense Rating than Unit C, the Inner Sphere player decides to attack Unit B. The Base Target Number for the attack is 7, the target's Defense Rating. The target is undamaged and in Plains terrain, so no modifiers for terrain or damage apply to the target number. However, the two other Clan units adjacent to Unit A (Units C and D) are friendly to the target; they apply a +2 harassment modifier, raising the modified Target Number to 9. The Inner Sphere player rolls 2D6 and gets a result of 10—a hit!

Now the Inner Sphere player must roll to see if his attack damaged the target. The Target Number for this roll is the target's Toughness Rating, also 7. The Inner Sphere player rolls 2D6 and gets a result of 6. He then adds the attacking unit's Attack Rating of 4 to the result, and also applies a harassment penalty of -2 (-1 for each 'Mech friendly to the target). The final result is 8 (6 + 4 - 2), high enough to damage the target. Unit B's player flips the unit's counter face-down.

Unit B retaliates by attacking Unit A. The Base To-Hit Number is 4, Unit A's Defense Rating. However, Unit A is standing in Woods/Jungle terrain,

which adds a +2 modifier to the target number. Also, Unit B is damaged, which adds another +2 modifier. The two Clan units adjacent to Unit A further modify the target number by -2. Finally, the attacker's position on Unit A's flank modifies the target number by -1. The final, modified target number is 5 (4 + 2 + 2 - 2 - 1). The Clan player rolls 2D6 and gets a 3; his attack misses.

## VICTORY

In general, combat ends when units from only one side occupy the field. As noncombatants, cities and supply convoys do not count toward determination of victory. If one side's forces consist only of cities and/or supply convoys, that side has lost the battle.

Bases and fortresses must be defeated in combat just like combat units. Once a base or fortress is destroyed, remove its counter from the battle board and return it to the map. These buildings are not literally destroyed, merely defeated, and so the attacking player's forces may occupy them (see **Control**, p. 77).

After battle, the victorious units remain in the battle hex on the planetary map. Units that fled the battlefield are placed as follows: the player on the winning side places his units in the battle hex, while the losing player places all of his fleeing units in any single adjacent hex containing other friendly units. If there are none, the player may place his units in any single adjacent hex desired, provided that the units may legally occupy it.

## DAMAGE

After the battle, all units are returned to the planetary map face-up and fully repaired. Damage has no effect on units once a battle is over.

## AEROSPACE UNITS

Aerospace combat works very much like other types of combat, except that certain special rules apply to attacks by aerospace fighters and DropShips. VTOLs, though technically air units, behave like ground forces in combat and so fight according to the rules given above.

## ATTACKING ON THE MOVE

Aerospace units usually attack on the move, strafing or bombing the target and then returning to base to refuel. This type of attack provides limited contact with the enemy but still delivers firepower to the battle zone.

A fighter or assault DropShip unit can make a single attack at any point during its movement, but not at the end of movement. If the unit ends its move in a hex with enemy units, the enemy units may attack it per standard rules.

To attack while moving, the player controlling the attacking unit must announce his intention to strike a single target in one of the hexes through which the attacking unit moved. Resolve this attack immediately in the same way as a single standard attack on the battle board, with a To-Hit Roll followed by a Damage Roll. If the attack destroys the target, the target cannot fight back. A target that is not destroyed may make a single attack against the aerospace unit. Neither the attacking nor defending unit can be damaged and not destroyed in this type of attack; they are either destroyed (total Damage Roll result of at least twice the target's Toughness Rating) or unscathed.

# PLANETARY ASSAULT

After each unit attacks once, the attacking unit's movement continues.

## COMBAT IN SPACE

Units that occupy the same orbit zone or the same hex on the System Diagram may engage in combat against each other. Because of the vast distances involved, units fight only if they choose to attack or are attacked by enemy units. In space, enemy units may co-exist in the same general area without conflict.

Only one orbital combat takes place in each orbit zone and System Diagram hex containing forces from both sides, though combat need not occur in those hexes. In each zone or hex occupied by forces from both sides, the player in whose Combat Phase the battle takes place announces which of his units are attacking, and nominates a single enemy unit in the hex or zone as the target. If the opposing player has units in the zone or hex in addition to the target, he must announce which of them will join the fight. Combat is then resolved using the battle board in the same way as combat on the planetary map (see **Attack Resolution**, p. 85 of this section).

## Orbital Bombardment

WarShips in orbit can use their massive armaments to attack ground targets, in a devastating form of assault called orbital bombardment. Like other attacks, orbital bombardments are launched during the attacking player's Combat Phase. A WarShip cannot make an orbital bombardment attack and fight another battle in the same turn. Each WarShip can only make one bombardment attack per turn.

To make a bombardment attack from orbit, the player controlling the WarShip nominates a single target unit. The target must occupy a hex in the planetary region corresponding to the orbit zone occupied by the WarShip.

If the target unit occupies a hex with enemy units and will therefore be engaging in combat with them, the bombardment attack is resolved during that combat. In that case, the bombardment counts as a single action for the player controlling the WarShip.

To determine whether the bombardment attack hits the target unit, roll 2D6 against a Base To-Hit number of 10, modified as appropriate for the skill of the WarShip unit. If the roll result is equal to or greater than the modified target number, the attack hits the target. If the roll result is less than the target number, the attack misses. A missed attack against a unit on the planetary map has no effect.

If the attack was aimed at a unit on the battle board, however, a missed bombardment attack will scatter. The base distance of scatter in this case is 1 box. To determine the direction of scatter, roll one die and consult the Bombardment Scatter



Table. The attack lands in the indicated box. If an attack scatters off the battle board, it has no effect.

If one unit is occupying the box where the attack lands, the bombardment hits that unit. If multiple units are occupying the indicated box, the attack hits one of them, chosen randomly.

When a bombardment attack hits a target, the player controlling the WarShip makes a Damage Roll against the target unit per standard rules. Unless attacking a target on the battle board, the target is either destroyed or unscathed.

## BOMBARDMENT SCATTER TABLE

1D6 Roll	Direction
1	Toward opponent
2	To the right
3	Toward attacking player
4	To the left
5-6	+1 box and roll again

# PLANETARY ASSAULT

## PLANETARY ASSAULT SCENARIOS

A scenario is a specific situation played out during a game. The scenario rules tell players which units to use, where to place them on the map and what each player must do in order to win the scenario. This section includes a basic **Planetary Assault** scenario for general use; guidelines for creating other kinds of scenarios can be found in **Advanced Scenarios**, p. 91.

### BASIC SCENARIO

The basic **Planetary Assault** scenario establishes one player as the attacker, whose goal is to land his forces on the planet's surface to capture all of its cities before he suffers so many casualties that victory becomes impossible. The opposing player is the defender, who seeks to destroy the attacker or drive his forces off the planet.

For purposes of default control of hexes, the basic scenario is played on a Minor World.

### FORCES

Each player selects forces up to an agreed-upon point total, concealing the composition of his force from his opponent. A recommended point level for a standard game is 200 points, with which players can purchase a fully-equipped BattleMech regiment. Players may use more points for a larger-scale (and longer) game, or fewer points for a smaller game.

Players may choose whatever forces they wish, within the following restrictions. The attacking player must have enough DropShip units to carry his entire assault force (including aerospace fighters). The defending player must have at least two cities on his world to serve as the attacker's targets. The more cities the defender purchases, the more difficult the attacker will find it to claim them all; however, points spent on cities reduce the amount available for the defender's other forces. Also, a defender with many cities must spread out his forces to protect a larger number of targets, which means fewer defenders per target. As a rule of thumb, three cities work well for a typical 200-point game. Finally, the basic scenario assumes that transport to the target system is available, and so players need not purchase JumpShips.

### Point Values

Point values for the various forces are listed on the Unit Purchase Tables in this section. To find a unit's point value, cross-reference the unit's type with its experience level.

The point value of each unit reflects its movement, attack and defense capabilities. However, the capabilities of battlefield units are not the only factors that affect the overall effectiveness of a fighting force. Terrain, for example, can have a significant impact on effectiveness in combat. Also, if the point totals of both sides are equal but one side outnumbered the other side, the smaller force will be at a disadvantage. Most important, the skill and experience of the controlling player is always a major factor in the effectiveness of a **Planetary Assault** force. Quantifying these factors in any meaningful way is virtually impossible, however, and so they are not represented in the point system.

The point values listed for Regular units are the standard point values for units that do not have an assigned experience level. Players should assume that all such units are Regular.

Some Clan and Inner Sphere unit types listed are followed by a technology code in parentheses: Inner Sphere Standard (IS), Inner Sphere Upgraded (IU), Clan Front-Line (C1) or Clan Second-Line (C2).

### UNIT PURCHASE TABLE: INNER SPHERE

UNIT TYPE	Green (+1)	Regular (+0)	Veteran (-1)	Elite (-2)
<b>BattleMech Units</b>				
Light 'Mech Co (IS)	5	6	7	8
Med 'Mech Co (IS)	7	8	9	10
Hvy 'Mech Co (IS)	10	11	12	13
Assault 'Mech Co (IS)	13	15	16	17
Light 'Mech Co (IU)	5	6	7	8
Med 'Mech Co (IU)	7	8	9	10
Hvy 'Mech Co (IU)	10	12	13	14
Assault 'Mech Co (IU)	13	16	18	19
<b>Ground Vehicle Units</b>				
Light Vehicle Co	4	5	6	7
Med Vehicle Co	7	9	10	11
Hvy Vehicle Co	9	12	14	15
Assault Vehicle Co	13	16	19	21
Supply Convoy	—	4	—	—
Ground Trans Co	5	6	7	8
Artillery Co	6	8	9	11
<b>VTOL Units</b>				
Attack VTOL Co	7	8	9	10
Air Transport Co	5	6	7	8
<b>Naval Units</b>				
Naval Trans Co	6	7	8	9
Submarine Co	9	12	14	15
<b>Infantry Units</b>				
Infantry Bn	5	6	7	8
Battle Armor Co (IS)	7	9	10	11
<b>Aerospace Fighter Units</b>				
Light Fighter Sqd (IS)	9	10	11	12
Med Fighter Sqd (IS)	11	13	14	16
Hvy Fighter Sqd (IS)	14	17	19	20
Light Fighter Sqd (IU)	10	11	12	13
Med Fighter Sqd (IU)	11	14	15	17
Hvy Fighter Sqd (IU)	14	17	20	21
<b>DropShip Groups (3 DropShips per group)</b>				
DropShip Group (Sm Trans)	13	15	16	17
DropShip Group (Med Trans)	15	17	18	19
DropShip Group (Lg Trans)	18	20	22	24
DropShip Group (Assault)	15	17	19	21
<b>JumpShip</b>	—	6	—	—
<b>WarShips</b>				
Small WarShip	26	31	36	40
Large WarShip	30	38	44	48
<b>Space Station</b>	8	9	10	11
<b>Settlements</b>				
Fortress	16	17	19	20
City	—	10	—	—
Base	—	7	—	—

# PLANETARY ASSAULT

## UNIT PURCHASE TABLE: CLAN

UNIT TYPE	Green (+1)	Regular (+0)	Veteran (-1)	Elite (-2)
<b>BattleMech Units</b>				
Light 'Mech Binary (C2)	5	6	7	8
Med 'Mech Binary (C2)	7	8	9	10
Hvy 'Mech Binary (C2)	10	12	13	14
Assault 'Mech Binary (C2)	13	16	18	19
Light 'Mech Trinary (C2)	7	8	9	10
Med 'Mech Trinary (C2)	8	10	11	12
Hvy 'Mech Trinary (C2)	13	15	17	19
Assault 'Mech Trinary (C2)	17	20	23	25
Light 'Mech Binary (C1)	6	7	8	9
Med 'Mech Binary (C1)	8	9	10	11
Hvy 'Mech Binary (C1)	11	13	15	16
Assault 'Mech Binary (C1)	14	17	20	21
Light 'Mech Trinary (C1)	7	9	10	11
Med 'Mech Trinary (C1)	10	12	14	15
Hvy 'Mech Trinary (C1)	14	16	19	21
Assault 'Mech Trinary (C1)	18	22	25	27
Light Supernova Binary (C1)	8	9	10	11
Med Supernova Binary (C1)	9	11	12	14
Hvy Supernova Binary (C1)	13	15	17	19
Assault Supernova Binary (C1)	17	20	23	25
Light Supernova Trinary (C1)	12	14	17	19
Med Supernova Trinary (C1)	15	19	22	25
Hvy Supernova Trinary (C1)	20	25	29	32
Assault Supernova Trinary (C1)	25	31	36	40
<b>Ground Vehicle Units</b>				
Supply Convoy	—	4	—	—
Ground Trans Binary	5	6	7	8
Ground Trans Trinary	7	8	9	10
Artillery Binary	6	8	9	11
Artillery Trinary	8	11	13	15
<b>VTOL Units</b>				
Air Transport Binary	5	6	7	8
Air Transport Trinary	6	7	8	9
<b>Naval Units</b>				
Naval Trans Binary	6	7	8	9
Naval Trans Trinary	8	9	10	11
<b>Infantry Units</b>				
Infantry Binary	5	6	7	8
Infantry Trinary	7	9	10	11
Battle Armor Binary (C1)	9	11	12	13
Battle Armor Trinary (C1)	12	14	16	18
<b>Aerospace Fighter Units</b>				
Light Fighter Star (C2)	10	11	12	13
Med Fighter Star (C2)	11	14	15	17
Hvy Fighter Star (C2)	14	17	20	21
Light Fighter Star (C1)	11	12	14	15
Med Fighter Star (C1)	13	16	18	19
Hvy Fighter Star (C1)	16	20	22	25
<b>DropShip Groups (3 DropShips per group)</b>				
DropShip Group (Sm Trans)	13	15	16	17
DropShip Group (Med Trans)	15	17	18	19
DropShip Group (Lg Trans)	18	20	22	24
DropShip Group (Assault)	15	17	19	21
<b>JumpShip</b>				
	—	6	—	—

UNIT TYPE	Green (+1)	Regular (+0)	Veteran (-1)	Elite (-2)
<b>WarShips</b>				
Small WarShip	26	31	36	40
Large WarShip	30	38	44	48
<b>Space Station</b>				
	8	9	10	11
<b>Settlements</b>				
Fortress	16	17	19	20
City —	10	—	—	—
Base	—	7	—	—

### DEFENDER SETUP

The defender sets up his forces first on the planetary map, beginning with cities and other settlements. Settlements must be placed on hexes containing land and generally should not be clustered too close together, as they will then be too easy to defend. As a rule of thumb, the defending player should place one settlement on each major continent (such as Asia or North America on Terra) before adding additional settlements on any continent. If players want a stricter rule to follow, they can decide that the defender may not place any settlement closer than six hexes to any other settlement.

After all settlements are placed, the defender places his units on the map, face-down in any hexes they are allowed to legally occupy (for example, BattleMech units cannot be deployed in Ocean hexes). DropShip and aerospace fighter units can be deployed on the planetary surface or in any desired orbit zone(s). Defending space stations must be placed in orbit, while defending JumpShips must be placed at the system's zenith or nadir jump point. Defending WarShips may be deployed in orbit or in any desired hexes on the System Diagram.

### ATTACKER SETUP

The attacker sets up after all defending units have been deployed. All attacking units begin play in space, having just arrived in the planet's hex on the System Diagram. Technically, all of the attacking units begin play in that hex, but players will find it easier to stack the units off to one side. Stack the units each DropShip is carrying beneath the DropShip's counter, so that the exact contents of each DropShip are concealed from the defender. Fighter units must be carried by DropShips, though they can launch during the first turn.

### VICTORY CONDITIONS

The game ends when one player has achieved his victory conditions, or when the game reaches a pre-determined time limit of a certain number of turns or hours. Players may set time limits by mutual consent. During the End Phase of each turn, check to see if either player has achieved the victory conditions as described below. Only check for fulfillment of the victory conditions (as well as siege conditions and so on) during the End Phase.

The attacker wins a Decisive victory by controlling all of the defender's cities and either controlling or destroying all of the defender's fortresses (see **Control**, p. 77). Bases need not be controlled or destroyed to claim victory. If the defender controls only a single city or fortress and that settlement is completely surrounded by attacking units during the End Phase for two

# PLANETARY ASSAULT

consecutive turns, the defender must surrender and the attacker wins a Marginal "siege" victory.

The defender wins by destroying enough of the attacker's forces to keep him from claiming victory. If the attacker ever has fewer ground units than the total number of cities and fortresses on the map, the defender wins.

## Victory Points

For a more precise measurement of victory, players can use the following point system. Both players start with 0 victory points. For every enemy unit destroyed, the player adds twice its point value to his total. For each of his own units destroyed, the player deducts the unit's point value from his total.

Players may score additional points for achieving victory conditions. In a basic scenario, each city or fortress in a player's possession at the end of the scenario adds points to that player's total. The exact value of each city and fortress varies depending on the total points used to purchase forces and the number of cities and fortresses in play. To find the value of each city or fortress, multiply the total points the defender used to buy forces by 2. Then divide that amount by the total number of cities and fortresses in play (round fractions normally). For example, if the defender spent 200 points buying forces and there are three cities and one fortress in play, each such settlement would be worth 100 points ( $200 \times 2 = 400$ ;  $400 \div 4 = 100$ ).

At the end of the scenario, the side with the highest point total wins. If the difference between the two players' totals is greater than the amount of points used to purchase forces for the winning side, the victory is Decisive. Otherwise, the victory is Marginal. If both players are tied, the game is a Draw.

## BASIC SCENARIO VICTORY TABLE

Action	Victory Points
Each enemy unit destroyed	+ Unit's Point Value x 2
Each friendly unit destroyed	- Unit's Point Value
Each city or fortress controlled	+ (Defender's total points x 2) ÷ number of cities and fortresses in play

## ADVANCED SCENARIOS

This section describes additional scenarios with more complicated setup or victory conditions than the basic scenario. Players can also use the following descriptions as guidelines for creating their own unique **Planetary Assault** missions. Combined with each player's ability to freely choose his own forces, the possibilities for creating different scenarios are virtually endless.

Unless otherwise noted, all of the following scenarios are played in the same way as the basic scenario described above. The players can either choose a scenario or roll on the Scenario Type Table to determine which scenario will be played. The assault scenario is played according to the basic scenario rules; special rules for the other scenario types appear in each one's description.

## SCENARIO TYPE TABLE

1D6	Scenario Type
1-2	Assault
3-4	Raid
5	Extraction
6	Last Stand

## RAID

In most thirty-first-century campaigns, the literal conquest of an entire planet is rarely the objective. The raid scenario represents the most common type of planetary assault. In a raid, the attacker seeks to destroy a single military target, cause as much damage as possible to enemy forces in the process and then leave the planet before losing too many of his own troops. The element of surprise is the attacker's biggest advantage in a raid; if the attacking forces stick around too long, reinforcements will have time to move in from all over the planet and crush them before they can pull out.

For purposes of default control of hexes, the raid scenario is played on a Minor World.

## Attacker

The attacking forces can consist of any desired units, following the basic scenario guidelines. As in the basic scenario, the attacking forces begin play aboard their DropShips.

The attacking forces arrive in-system via JumpShip on the first turn. Attempting a pirate point arrival is in the attacking player's best interest, as it will allow him to maximize the temporary advantage of surprise.

After the defender sets up his forces, but before the start of the first turn, the attacking player secretly selects one of the defender's bases as his raid target, writing down the number of the hex the base occupies and keeping it hidden from his opponent.

## Defender

The defending player has 150 percent as many points as the attacking player with which to purchase forces, but those forces may not include any JumpShips or WarShips. The defending player cannot purchase cities or fortresses; he has bases instead, one of which will serve as the opponent's objective. The defender must have at least one base per 100 points or fraction thereof. Also, the defender may not purchase more than one DropShip unit per 200 points.

The defender deploys first, placing his bases according to the basic scenario guidelines for city placement and then placing his units according to the basic scenario rules, except that fighter and DropShip units must start play on the planet's surface.

## Special Rules

The defending forces outnumber the attackers, but the defenders are unaware of the pending attack. No defending unit may move until the defender detects the approaching enemy forces. In the End Phase of each turn, the defender rolls one die. If the result is equal to or less than the current turn number, the defender has detected the attacking forces. Once this occurs, defending forces may move normally. Any defending

# PLANETARY ASSAULT

units that come under attack may move normally following the attack, even if the detection roll fails.

## Victory Conditions

The scenario ends when all defending units are destroyed, or when all attacking units are either destroyed or have escaped. To escape, an attacking unit must reach the zenith or nadir jump-point hex on the System Diagram. A JumpShip need not be present in the hex. The attacker can choose to have his units escape at any time, even before the target of the raid is destroyed.

The attacker wins by destroying the raid target and then escaping from the planet. The defender wins by protecting the target and destroying attacking units. To determine who won the scenario, add up victory points for each side as shown on the Raid Victory Table and use the standard victory rules.

### RAID VICTORY TABLE

Action	Victory Points
<i>Attacker</i>	
Each defending unit destroyed	+ Unit's Point Value
Each attacking unit destroyed	- Unit's Point Value
Each attacking unit escaped	+ Unit's Point Value
Raid target destroyed	+ Defender's total points
<i>Defender</i>	
Each attacking unit destroyed	+ Unit's Point Value x 3
Each defending unit destroyed	- Unit's Point Value
Raid target not destroyed	+ Attacker's total points

## EXTRACTION

In an extraction scenario, the attacking player attempts to extract a target, such as a secret weapon, an important prisoner or a computer memory core, from the defender's planet. Unlike the raid scenario, the target is well-defended and the attacker does not know its exact location. The attacker must locate the extraction target, defeat its guardians and take it off the planet intact.

For purposes of default control of hexes, the extraction scenario takes place on a Major World.

### Attacker

The attacking forces can consist of any desired units, following the basic scenario guidelines. The attacking forces begin play aboard their DropShips, as in the basic scenario, and arrive in-system via JumpShip on the first turn.

### Defender

The defending player has the same number of points as the attacker for purchasing forces.

The defender deploys first, according to the basic scenario guidelines for unit placement. In addition, the defending player places two objective counters and a headquarters counter on the map, each face-down in any land hex desired. Each of the three counters must be in a different hex. The headquarters counter represents the extraction target; the objective counters are decoys.

## Special Rules

At the start of the game, the attacker does not know which objective counter is the extraction target because they are all face-down. In order to flip over a counter and reveal its identity, one attacking unit must be in the hex with the counter during the End Phase of a turn. Merely entering the hex is not enough; the attacking unit must also survive any combat in the hex before flipping the counter over.

Once the attacker finds the headquarters counter, his forces must transport the item or person to be extracted off the planet on a DropShip. Any attacking ground unit or transport VTOL unit can carry the extraction objective along with it as it moves. The carrying unit need not have Transport Capacity. The objective may move once per turn, just like a unit being transported (see **Board/Disembark Transport**, p. 81). Once the headquarters counter is in a hex with an attacking DropShip, it can be loaded aboard and taken off-planet. The extraction target does not count against the Transport Capacity of the unit carrying it.

The defending player cannot pick up or move the headquarters counter. He also may not attack or destroy the extraction target, as it is too valuable to both sides. Once the extraction target is in a hex with an attacking DropShip in the End Phase of a turn, the scenario ends and the attackers are considered to have achieved their objective.

## Victory Conditions

The scenario ends when all defending units are destroyed, when all attacking units are destroyed or when the extraction target is in the same hex with an attacking DropShip.

The attacker wins by capturing the extraction target with a minimum of casualties. The defender wins by protecting the extraction target and destroying attacking units. To determine who won the scenario, add up victory points for each side as shown on the Extraction Victory Table and use the standard victory rules.

### EXTRACTION VICTORY TABLE

Action	Victory Points
<i>Attacker</i>	
Each attacking unit destroyed	- Unit's Point Value
Extraction target captured	+ Defender's total points x 2
<i>Defender</i>	
Each attacking unit destroyed	+ Unit's Point Value
Each defending unit destroyed	- Unit's Point Value
Extraction target not captured	+ Attacker's total points

## LAST STAND

Throughout the ages, tales have been told of legendary heroes who stood their ground in the face of incredible odds and snatched victory from the jaws of defeat. This type of scenario represents just such a situation.



# PLANETARY ASSAULT

The last-stand scenario assumes that the defender's DropShips were sabotaged in the initial stages of the assault, effectively stranding the defender on the planet with no avenue of escape. Faced with a far superior attacking force, the defenders refuse to surrender. Instead, they stage a desperate delaying action in the hopes that reinforcements will arrive in time to save the planet. The attackers must root out the defending forces and secure the planet's settlements before reinforcements arrive.

For purposes of default control of hexes, the last-stand scenario is played on a Minor World.

## Attacker

The attacking forces can consist of any desired units, following the basic scenario guidelines. The attacker has twice as many points with which to buy forces as the defender; for example, if the defender has 150 points, the attacker has 300. Attacking forces begin play aboard their DropShips, as in the basic scenario, and arrive in-system via JumpShip on the first turn.

## Defender

The defending player has half as many points as the attacker with which to purchase forces. Defending forces are purchased according to the basic scenario guidelines, except that the defender can purchase no DropShips, JumpShips, WarShips or fortresses.

The defender also has a relief force equal in point value to his main force. The relief troops must include enough DropShips to transport the rest of the forces to the planet, just like an attacking force, and may include any types of units desired. The relief force is well trained and highly motivated, and so all of its units increase their Quality Ratings by one in combat to a maximum of Elite. For example, a relief unit purchased as Regular fights like a Veteran unit.

The defender deploys first according to the basic scenario guidelines. In addition, the defending player places two objective counters and a headquarters counter on the map, each face-down in any land hex desired. Each of the three counters must be in a different hex. The headquarters counter represents the defender's secret headquarters bunker; the objective counters are trapped decoys consisting of minefields, automated defenses and local partisans.

The relief force does not start play on the map. In each End Phase, the defending player rolls 1D6. If the result is equal to or less than the current turn number, the relief force will arrive via JumpShip in the following turn. This means those forces automatically arrive in Turn 7 if they have not done so earlier.

## Special Rules

The defender is coordinating his planet-wide defenses from a secret bunker, represented by the headquarters counter. Until the attacker captures the bunker, the defending forces gain the following advantages from their improved communications. The MP allowance of all defending units on the planetary map (not on the battle board or in space) increases by 1, and the defending units are more difficult than normal for the attacker to identify. Apply a +2 modifier to the die roll whenever the attacker attempts to identify a face-down defending unit (see **Reconnaissance**, p. 81).

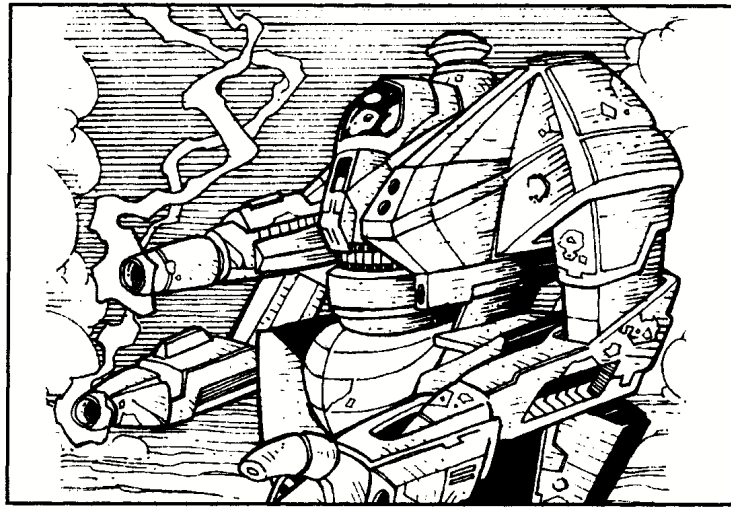

The objective and headquarters counters are too well concealed to be identified by air. If an attacking ground unit enters a hex with a face-down objective or headquarters counter, the attacking player flips the counter over at the end of his Movement Phase. If it is the headquarters counter, nothing else happens. If the attacking unit remains in the hex until the End Phase and no defending units enter the hex, the headquarters is captured. The headquarters can be used by whichever side occupies it, so attackers who capture it gain the benefits described in the preceding paragraph. The defender's forces can recapture the bunker.

If the counter is an objective counter, a trap has been sprung on the attacking force. At the beginning of the attacker's Combat Phase, before any battles are resolved, all attacking ground units in the trap hex suffer a single attack. (Air units and defending units in the hex are unaffected by the trap.) Resolve this as an attack from a Green unit with an Attack Value of 4. No other modifiers apply to the To-Hit or Damage rolls. The target is either destroyed or unscathed. Once the trap attack(s) have been resolved, remove the objective counter from play.

## Victory Conditions

The scenario ends if the attackers destroy all defending units and control all the cities and fortresses on the map before the first relief force unit arrives on the planet's surface. If the first relief force unit makes it to the planet, the scenario continues and the basic scenario victory conditions apply.

If the attackers win before the relief force arrives, the victory is Decisive. Otherwise, to determine who won the scenario, add up victory points for each side as shown on the Last Stand Victory Table and use the standard victory rules.

## LAST STAND VICTORY TABLE

Action	Victory Points
Each enemy unit destroyed	+ Unit's Point Value x 2
Each friendly unit destroyed	- Unit's Point Value
Each city controlled	+ (Attacker's total force purchase points x 2) ÷ number of cities in play

# PLANETARY ASSAULT



## LARGER-SCALE SCENARIOS

The game rules and counters provided with **BattleForce 2** are designed to accommodate a fairly typical planetary assault scenario. The number of forces on each side can range anywhere from a single battalion to three fully supported 'Mech regiments. Players who wish to play larger-scale games may do so, provided they make the adjustment of either adding more counters to the game or playing on a larger scale.

## ADDITIONAL COUNTERS

For a somewhat larger game, players can simply add more counters by purchasing an additional **BattleForce 2** game or borrowing counters from a friend's game.

Note that the counters are numbered sequentially across both players' sets; the Inner Sphere assault 'Mech counters are numbered 1-3, while the Clan assault 'Mech counters are numbered 4-6. This facilitates the exchange of counters from one side to the other.

## LARGE SCALE PLAY

For really big battles, simply adding more counters is not sufficient. Massive campaigns such as the battles of Tukayyid or Luthien, which involved dozens of regiments, cannot be effectively played at the standard **Planetary Assault** scale. Even with enough counters available, the map would be so crowded with pieces that players would find it difficult to actually play the game.

For battles such as these, players can simply increase the game scale one level. Each unit represents a larger formation than in the standard rules, but the units still move and interact in the same way. For example, Inner Sphere BattleMech units are normally deployed in companies. At large scale, they are deployed in battalions. However, the unit is treated exactly the same way for purposes of playing the game.

The Large-Scale Conversion Table lists the standard-scale unit types and their large-scale equivalents.

Large scale must apply to all units in play or none of them. Players cannot apply it only to one side or to a single unit. If a FASA scenario is to be played at large scale, the setup rules will state that requirement.

## LARGE-SCALE CONVERSION TABLE

Standard Scale	Large Scale
Company	Battalion
Battalion	Regiment
Squadron	Wing
Star	Trinary
Binary	Small Cluster (6-10 Stars)
Trinary	Large Cluster (11-15 Stars)
Supernova Binary	Small Nova Cluster (6-10 Novas)
Supernova Trinary	Large Nova Cluster (11-15 Novas)
DropShip Group	DropShip Fleet (9 Vessels)
Space Craft	Space Craft Group (3 Vessels)

# PLANETARY ASSAULT

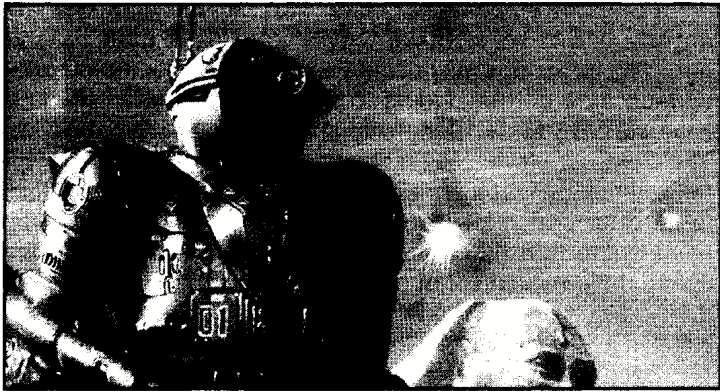

## THE FALL OF TERRA

The following large-scale scenario recreates Operation Odysseus, the epic battle between ComStar, the powerful organization that has controlled interstellar communications for nearly three hundred years, and the radical splinter group of ComStar known as the Word of Blake. The Word of Blake used cunning and subterfuge to stage a bold attack on Terra, homeworld of ComStar and birthplace of humanity.

### SITUATION

*Terra*  
28 February 3058

Ever since the ComStar schism that occurred in the summer of 3052, the Word of Blake had coveted Terra. In late 3057, the collapse of the Federated Commonwealth's Sarna March and the Refusal War between Clans Jade Falcon and Wolf gave them the opportunity they needed. The enemy leadership was distracted and the worlds near Terra were in chaos, and the Word of Blake lost no time in striking.

Though outnumbered at the start of the campaign, the Word of Blake forces on Terra had one major advantage: surprise. No one suspected an assault was imminent, let alone that the first blow would come from within.

### GAME SET-UP

The scenario begins on February 28. Players should note the number of turns played for purposes of determining victory.

This **Planetary Assault** scenario is played on the larger scale. Treat Terra as a Major World for purposes of determining control of hexes.

This scenario does not use bases; instead, base counters represent cities, while city counters represent fortresses. Hilton Head, the ComStar headquarters, is represented by a fortress counter.

Place cities and fortresses as follows. Use base counters to represent the following cities: Moscow, Hex D19; Tokyo, Hex E01; Sydney, Hex L01; Delhi, Hex F21; Sao Paulo, Hex K12.

Use city counters to represent the following fortresses: Cairo Castle Brian (Veteran), Hex F18; Sandhurst Castle Brian (Veteran), Hex D16; Mars War Academy (Veteran), Hex 0802.

Use a fortress counter to represent the following fortress: Hilton Head Castle Brian (Elite), Hex F11.

### DEFENDER

The defenders are ComStar's Terran garrison, comprising the 201st Com Guards division, the Sandhurst training regiment and various ad hoc units.

#### 201st Com Guards Division (The Winged Warriors IV-Beta)

Alpha Battalion: Med 'Mech Bn (IS/Veteran) MM1  
Beta Battalion: Med 'Mech Bn (IU/Veteran) MM2  
Gamma Battalion: Hvy 'Mech Bn (IU/Veteran) MH1  
Delta Battalion: Hvy 'Mech Bn (IS/Veteran) MH2  
Epsilon Battalion: Med Fighter Wing (IU/Veteran) FM1  
Zeta Battalion: Med 'Mech Bn (IU/Regular) MM3  
Support Detachment: Supply Convoy (Regular) GC1

#### Sandhurst Training Regiment

Level III Alpha: Hvy 'Mech Bn (IU/Green) MH3  
Level III Beta: Med 'Mech Bn (IU/Green) MM4  
Level III Gamma: Med 'Mech Bn (IU/Green) MM5

#### Primus's Bodyguard

Light Vehicle Bn (Veteran) GL1

#### Branch of Terran Affairs Security Group

Hvy Vehicle Bn (Veteran) GH1

#### ROM Corps

Med 'Mech Bn (IU/Elite) MM6

#### War Academy Cadets (Mars)

Med 'Mech Bn (IU/Green) MM7

#### Aphros Security Corps (Venus)

Light 'Mech Bn (IU/Regular) ML1

#### Terran Security Fleet

DropShip Fleet (Assault/Veteran) DA1  
DropShip Fleet (Med/Regular) DM1  
Hvy Fighter Wing (IU/Veteran) FH1  
Light Fighter Wing (IU/Veteran) FL1

#### Stations

Brandenburg Station: Space Station (Veteran) SP1  
Brandenburg Wing: Hvy Fighter Wing (IU/Veteran) FH2  
Versailles Station: Space Station (Veteran) SP2  
Versailles Wing: Med Fighter Wing (IU/Elite) FM2

### Deployment

The ComStar player deploys first.

The 201st Division is deployed as follows: Alpha and Beta battalions within two hexes of New York (Hex E11), Gamma Battalion within two hexes of Moscow (Hex D19), Delta Battalion on the Asian mainland within 2 hexes of Shanghai (Hex F24), Epsilon Battalion within 1 hex of Sao Paulo (Hex K12) and Zeta Battalion in Sydney (Hex L02).

The Primus's bodyguard unit is placed in the Florida hex (Hex F10). The Branch of Terran Affairs Security Group is deployed in the Italy/Southern Europe hex (Hex E16). The Sandhurst Training Regiment is deployed in the British Isles hex (Hex D16), and the ROM Corps is placed in Cairo (Hex F18).

The War Academy cadets are deployed in the third-planet hex on the System Diagram (Hex 0802, representing Mars); the Aphros Security Corps are placed on the first-planet hex (Hex 0804, representing Venus).

Brandenburg Station and its fighter wing are placed at the nadir jump point, Versailles Station and its fighter wing at the zenith. The Terran Security Fleet is deployed in Terran orbit. The units can be in the same orbit zone or in different zones of the ComStar player's choice.

ETECH

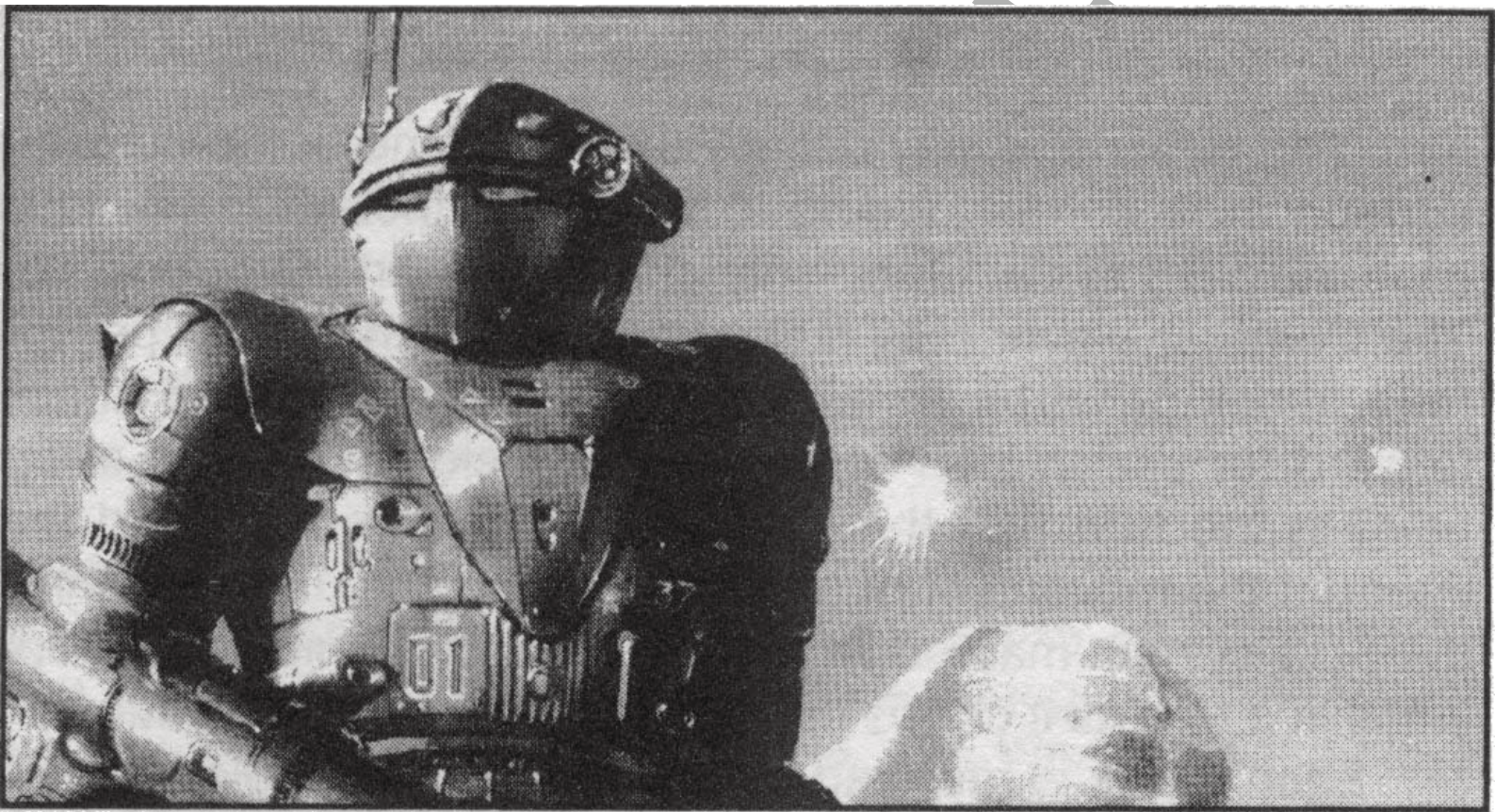

Русская

# PLANETARY ASSAULT

## ATTACKER

The attackers are the Word of Blake-controlled Shadow Lancers.

## Shadow Lancers

1st Battalion: Med 'Mech Bn (IU/Elite) MM13  
2nd Battalion: Hvy 'Mech Bn (IU/Veteran) MH10  
3rd Battalion: Med 'Mech Bn (IU/Veteran) MM14  
Air Lancers: Med Fighter Wing (IU/Veteran) FM4  
Armor Lancers: Med Vehicle Bn (Veteran) GM13  
Hvy Vehicle Bn (Veteran) GH10  
Infantry Lancers: Infantry Rgt (Veteran) IN24  
Support Detachment: Supply Convoy (Regular) GC11

## Deployment

The Word of Blake player deploys second, placing the Lancer units in any desired hexes within 1 hex of the Great Lakes hex (Hex D11). Word of Blake units may begin the scenario in the same hex as ComStar forces.

See **Special Rules**, below, for information on Word of Blake special forces and reinforcements.

## VICTORY CONDITIONS

The scenario ends at any point after Turn 5 if one side controls every city and fortress on Terra and also Mars in the End Phase, or when one side is eliminated. The scenario does not continue past the end of Turn 20. To determine the winner and level of victory, see the Victory Table.

### VICTORY TABLE

#### Action

Com Guards forces eliminated by Turn 5  
All settlements seized by Turn 5  
All settlements seized by Turn 11  
All settlements seized by Turn 20  
At least 1 settlement remains under ComStar control in Turn 20  
At least 3 settlements remain under ComStar control in Turn 20  
More than 5 settlements remain under ComStar control in Turn 20 or all Word of Blake forces eliminated

#### Result

Decisive Word of Blake Victory  
Substantial Word of Blake Victory  
Marginal Word of Blake Victory  
Draw  
Marginal ComStar Victory  
Substantial ComStar Victory  
Decisive ComStar Victory

## SPECIAL RULES

The unique nature of the Terran system, combined with the Word of Blake's sabotage tactics, give this scenario several special rules.

### BASES

As stated in **Game Setup**, base counters in this scenario represent and follow all the standard rules for cities. Supply convoys cannot create new bases.

### SDS SYSTEM

Terra is the only planet in the Inner Sphere that retains a viable surface-to-orbit weapons system modeled on the Reagan Space Defense System. A series of orbiting mirrors allows ground-based batteries to engage any targets in near orbit.

For game purposes, ComStar may use the SDS system to engage one Word of Blake DropShip unit per orbit zone per turn. The target unit may occupy the orbit zone or the planetary surface area corresponding to the zone, though in the latter case the SDS system may only attack a moving DropShip unit. The ComStar player may make up to ten such attacks per turn (one attack per orbit zone); he may not carry unused attacks forward for use in later turns. Such attacks take place at any point in the turn that the ComStar player chooses, and may interrupt the movement of a Word of Blake unit. In this manner, the SDS system may engage an orbiting DropShip unit multiple times in a turn as it circles the planet (once with each battery).

Each attack is resolved per standard combat rules, with an Attack Value of 7 and no to-hit modifiers. Unless it destroys the target DropShip unit outright, the attack has no effect. To destroy the DropShip unit, the modified damage roll result must be double or more the target unit's Toughness Rating.

Ground or space units may not destroy the SDS system; only special forces can disable it (see **Special Forces**).

### SPECIAL FORCES

Special forces played a key role in the Word of Blake's seizing of Terra; they eliminated enemy commanders, sabotaged units and disabled the SDS system. For purposes of this scenario, special forces units may carry out no more than eight operations per turn, each of which must be one of the following. Unused operations are lost. Special forces operations may take place at any point in a turn, unless noted otherwise below.

A disastrous failure or other result that reduces allowed operations by 1 means that the special forces team was captured or destroyed. Each such result reduces by 1 the total number of special forces operations that the Word of Blake player may use in each turn. After 8 such results, the Word of Blake player

may no longer use special forces for the rest of the scenario.

### SDS Attack

In an SDS attack operation, a Word of Blake special forces team attempts to infiltrate and disable one of Terra's Space Defense System installations. The Word of Blake player nominates an orbit zone and rolls 1D6, comparing the result to the SDS Attack Table.

On a successful result, the SDS may no longer be used against targets in that orbit zone.

# PLANETARY ASSAULT

## SDS ATTACK TABLE

1D6	Result
1-2	Disastrous failure; reduce allowed operations by 1
3	Failure
4-6	Success

### Sabotage

A successful act of sabotage can destroy an entire enemy unit or fortress, but the operation is very dangerous and usually costs the special forces team its life. The Word of Blake player nominates a single ComStar unit or a fortress as the target of the operation and rolls 1D6, then compares the result to the Sabotage Table.

On a successful result, a single attack with an Attack Value of 4 strikes the target. The Word of Blake player need not make a to-hit roll. If the operation is executed against a unit or fortress engaged in combat on the battle board, the unit or fortress may be damaged by the attack. Otherwise, the attack has no effect unless the target is destroyed outright, or unless the attack is immediately followed by another successful sabotage operation that damages the target unit or fortress, thereby destroying it.

## SABOTAGE TABLE

1D6	Result
1-3	Disastrous failure; reduce allowed operations by 1
4-5	Success; reduce allowed operations by 1
6	Success

### Headhunter

Perhaps the most reprehensible yet effective of special forces operations, the headhunter mission seeks to eliminate enemy officers through assassination, thereby severely disrupting the chain of command and throwing the target unit into disarray. The Word of Blake player nominates a single ComStar unit as the target of the operation and rolls 1D6, then compares the result to the Headhunter Table.

On a successful result, place an ECM, objective or other unused counter on the target unit to indicate that it is disrupted. A disrupted unit is revealed immediately if it was face-down, and cannot move as long as it remains disrupted. In combat, a disrupted unit can move normally on the battle board, but cannot benefit from harassment modifiers supplied by friendly units and fights with a +1 modifier to all to-hit target numbers.

Disruption counters may be removed by the player controlling the disrupted unit during the End Phase of the turn. If a friendly unit is in the hex with the disrupted unit, the counter is removed automatically. For this purpose, settlements do not count as friendly units. If the unit is alone in the hex, the controlling player must make a 2D6 roll with a result of 8 or better to remove the counter; otherwise the unit remains disrupted.

## HEADHUNTER TABLE

1D6	Result
1-2	Disastrous failure; reduce allowed operations by 1
3	Failure
4-5	Success; reduce allowed operations by 1
6	Success

### MARS AND VENUS

Treat these two worlds as single hexes of Mountain terrain in which ground battles may be fought. Units may land normally, but need not enter orbit or make a landing roll. If the hexes representing Mars and Venus are unoccupied at any time, control of those hexes reverts to ComStar.

### WORD OF BLAKE REINFORCEMENTS

The main Word of Blake invasion force arrives via JumpShip in the End Phase of Turn 1. The Word of Blake player should assign units to DropShips and DropShips to JumpShips before rolling for each JumpShip's arrival. ComStar's hyper-accurate maps of the Terran system greatly reduces the chance of a mis-jump, allowing a more effective use of pirate points. To reflect this, when rolling to see if a jump is successful, apply a -2 modifier to the target number.

#### Invasion Fleet

- 3 JumpShip Groups (Regular) JU2-4
- DropShip Fleet (Med Trans/Veteran) DM3
- DropShip Fleet (Assault/Veteran) DA2
- 2 DropShip Fleets (Lg Trans/Regular) DH3, DH4
- DropShip Fleet (Sm Trans/Regular) DL4

#### 2nd Word of Blake Division (Stern Resistance IV-Mu)

- Hvy 'Mech Bn (IU/Veteran) MH11
- Med 'Mech Bn (IU/Regular) MM15
- Light 'Mech Bn (IU/Regular) ML10
- Light Vehicle Bn (Veteran) GL7
- Hvy Vehicle Bn (Regular) GH11

#### 3rd Word of Blake Division (Pure Thought/Actions IV-Iota)

- Med 'Mech Bn (IU/Elite) MM16
- Assault 'Mech Bn (IU/Veteran) MA4
- Heavy 'Mech Bn (IU/Regular) MH12
- Med Vehicle Bn (Veteran) GM14
- Infantry Rgt (Veteran) IN25

#### 4th Word of Blake Division (Blake's Boldest IV-Chi)

- Med 'Mech Bn (IS/Veteran) MM17
- Hvy Vehicle Bn (Veteran) GH12
- Med Vehicle Bn (Regular) GM15
- Infantry Rgt (Veteran) IN26

#### 5th Word of Blake Division (The Chosen IV-Kappa)

- Med 'Mech Bn (IU/Veteran) MM18
- Hvy 'Mech Bn (IU/Regular) MH13
- Med 'Mech Bn (IU/Regular) MM19
- Med Fighter Wing (IU/Regular) FM5
- Hvy Vehicle Bn (Regular) GH13

#### Operation Odysseus Support Detachment

- Artillery Bn (Veteran) AR6
- Infantry Rgt (Veteran) IN27
- 4 Supply Convoys (Regular) GC12-15

## PLANETARY ASSAULT

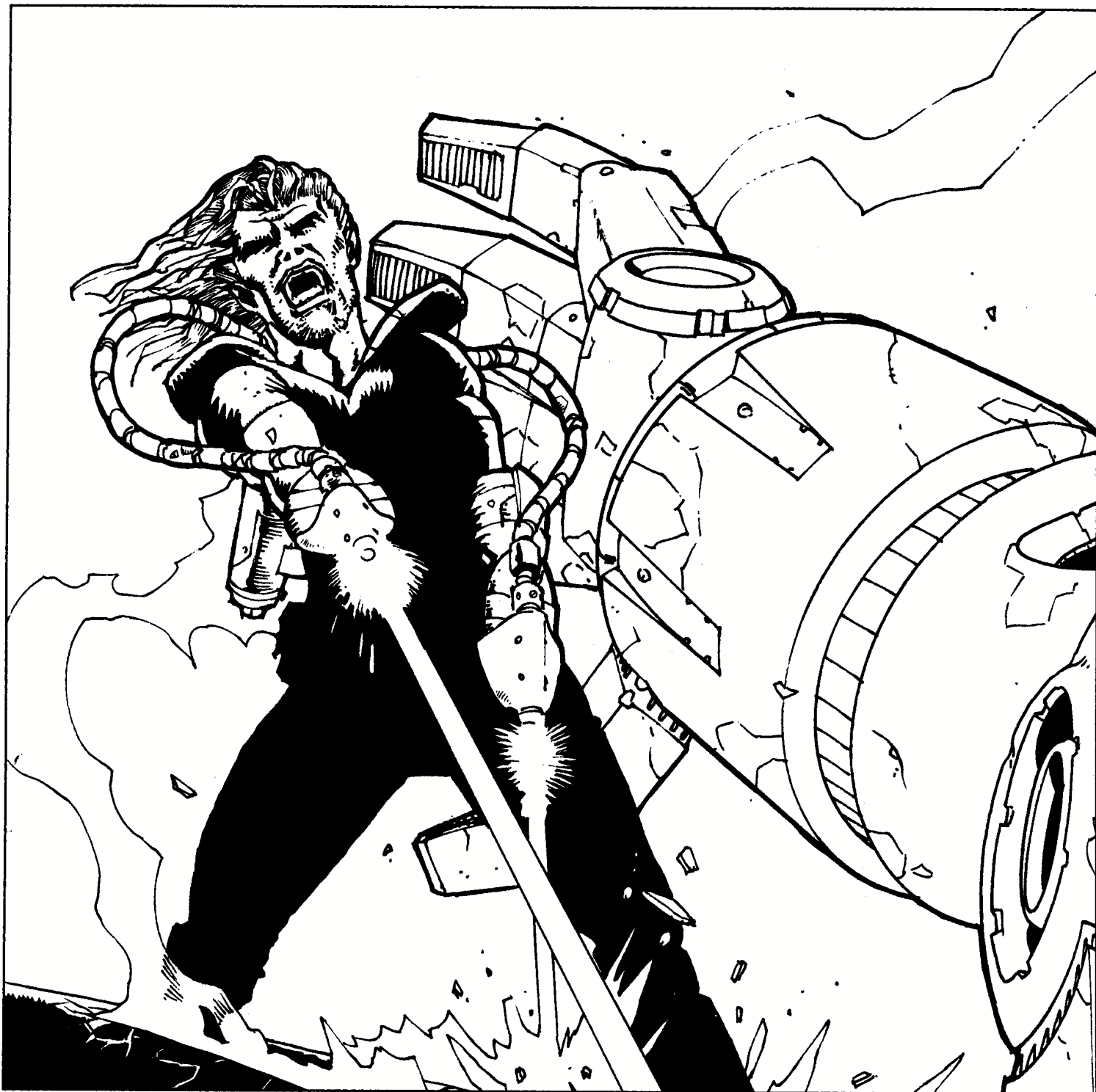

### AFTERMATH

Total surprise allowed the Word of Blake to shatter Com Guards resistance in the first hours of the invasion, with special forces operations devastating the ComStar chain of command. Despite this, ComStar made a valiant attempt at holding off the aggressors; had one or two engagements gone their way, or some of the special forces operations failed, the outcome could have been very different.

The Word of Blake captured major Terran sites by March 2 and had eliminated large-scale resistance by March 5. Hostilities formally ended on March 7, but a low-level guerrilla war continued for a number of months. For Word of Blake Precentor Martial Trent Arian, the victory was Pyrrhic; what should have been a relatively simple coup d'etat turned into a bloody clash that cost thousands of lives and destroyed property worth billions of C-bills.

**BATTLEFORCE 2**





# APPENDICES

## APPENDICES

This section of **BattleForce 2** contains rules for using **BattleForce** and **Planetary Assault** in conjunction with other games in the **BattleTech** line. It includes conversion rules for **BattleTech** and **BattleSpace** units, as well as guidelines for using the map of the Inner Sphere to run multi-planet campaigns.

### APPENDIX I: BATTLETECH CONVERSION

The **BattleForce** statistics for each BattleMech and vehicle derive directly from their **BattleTech** statistics. The **BattleForce Roster** (p. 118) contains pre-generated **BattleForce** statistics for all **BattleTech** forces that existed as of the printing of this game (December 1997). Future **BattleTech** products that feature new units will also provide **BattleForce** conversions for them. The following rules explain how to convert your own 'Mech and vehicle designs into **BattleForce** terms.

Throughout these rules, keep in mind that an individual 'Mech or vehicle is referred to as a unit in **BattleTech** but an element in **BattleForce**.

#### MOVEMENT

In **BattleForce**, an element's MP is equal to its **BattleTech** Walking (Cruising) MP. If a **BattleTech** unit has Jumping MP at least equal to its Walking MP, its movement in **BattleForce** is considered Jumping (marked with a "J" on the record sheet). If the Jumping MP is less than the Walking MP, the unit is not considered a Jumping element in **BattleForce**.

#### ARMOR/STRUCTURE

The following tables determine **BattleForce** Armor and Structure values for BattleMech elements. To find an element's Armor Value, find the 'Mech's total **BattleTech** Armor Factor in the left column; the equivalent **BattleForce** Armor Value appears in the right column. The Structure Value is based on the 'Mech's tonnage and the type of engine it carries. Because an XL engine makes a 'Mech much more vulnerable to critical damage and destruction, 'Mechs carrying such engines have a lower Structure Value than other 'Mechs. To find a 'Mech's Structure Value, read across the table from the 'Mech's tonnage to the appropriate engine type column.

For vehicles, total the internal structure and armor (including turrets or rotors if the vehicle has one) and divide the total by 30 (use standard rounding). The result is the vehicle element's Structure Value.

For infantry units, start with the total damage the infantry unit can take before being destroyed. If the unit is battle-armored, add the number of troopers in the unit times 5. Then divide the total by 30 (use standard rounding). The result is the infantry element's Armor Value.

#### DAMAGE VALUES

A **BattleForce** element's complement of weapons does damage at three ranges: pointblank, medium and long. Determining these values from **BattleTech** statistics consists of three steps, explained in detail below. First, find the base damage done at each range. Then adjust this damage based on the

### BATTLEMECH ARMOR CONVERSION TABLE

BT Armor Factor	BF Armor Value
0-19	0
20-59	1
60-99	2
100-139	3
140-179	4
180-219	5
220-259	6
260-299	7
300+	8

### BATTLEMECH STRUCTURE CONVERSION TABLE

'Mech Tons	Engine Type		
	Standard	Clan XL	Inner Sphere XL
10	1	1	1
15	1	1	1
20	2	1	1
25	2	2	1
30	3	2	1
35	3	2	1
40	3	3	2
45	4	3	2
50	4	3	2
55	5	3	2
60	5	4	2
65	5	4	3
70	5	4	3
75	6	4	3
80	6	5	3
85	7	5	3
90	7	5	3
95	7	5	4
100	8	6	4

heat generated. Finally, divide the modified total for each range by 10 to find the final Damage Value for that range. If the unit can overheat by firing all of its weapons and moving in the most heat-intensive way possible, the element may need to have an Overheat Value as well (see **Overheat Value**, p. 102).

The relevant **BattleTech** statistics appear in the Weapons and Equipment Tables, pp. 104-106 of the **BattleTech Compendium: The Rules of Warfare** or pp. 125-127 of **Maximum Tech**.

#### Base Damage

To find the base damage, first add up all weapon damage that can reach each range (pointblank, medium and long). See the Weapon Conversion Table for the weapons in each range. Each weapon can reach the range listed, as well as each shorter range. For example, a medium laser (listed as a medium-range weapon) can do damage at both medium and pointblank range.

# APPENDICES

## WEAPON CONVERSION TABLE

### INNER SPHERE WEAPONS

#### Pointblank Range

Flamer  
 Flamer (vehicle)  
 Hatchet  
 Machine Gun  
 Pulse Laser (Small)  
 Small Laser  
 Sword (Physical Attacks: Tonnage ÷ 5)

#### Medium Range

AC/10  
 AC/20  
 ER Medium Laser  
 ER Small Laser  
 Large Laser  
 LB 20-X AC  
 Medium Laser  
 MRMs\*\*\*\*  
 Pulse Laser (Large)  
 Pulse Laser (Medium)  
 SRMs  
 Streak SRMs  
 Ultra AC/20

#### Long Range

Artillery\*\*\*  
 AC/2\*\*  
 AC/5\*  
 ER Large Laser  
 ER PPC  
 Gauss Rifle\*  
 LB 2-X AC\*\*  
 LB 5-X AC\*  
 LB 10-X AC  
 Light Gauss Rifle\*  
 LRMs\*\*  
 PPC\*  
 Ultra AC/2\*

Ultra AC/5\*  
 Ultra AC/10

### CLAN WEAPONS

#### Pointblank Range

Flamer  
 Flamer (vehicle)  
 Machine Gun  
 (Physical Attacks: Tonnage ÷ 5)

#### Medium Range

ER Medium Laser  
 ER Small Laser  
 LB 20-X AC  
 Pulse Laser (Medium)  
 Pulse Laser (Small)  
 SRMs  
 Streak SRMs  
 Ultra AC/20

#### Long Range

Artillery\*\*\*  
 ER Large Laser  
 ER PPC  
 Gauss Rifle\*  
 LB 10-X AC  
 LB 2-X AC\*\*  
 LB 5-X AC\*  
 LRMs  
 Pulse Laser (Large)  
 Ultra AC/10  
 Ultra AC/2\*  
 Ultra AC/5

\*3/4 damage at pointblank range

\*\*1/2 damage at pointblank range

\*\*\*1/2 damage at pointblank and medium ranges

\*\*\*\*1/2 damage at medium range

Next, apply any of the following as appropriate to the base damage calculations. The final result is the base damage.

**Range Modifiers:** Weapons with minimum ranges, as well as certain other weapons such as artillery and MRMs, modify their damage for this characteristic. The specific modifier and the range(s) to which it applies are noted with asterisks on the Weapons lists.

**Physical Attacks:** To account for physical attacks, add the 'Mech's tonnage divided by 5 to the pointblank range damage. If the 'Mech has a hatchet or sword, add the damage for that weapon as well. Physical attack damage only applies to BattleMech elements.

**Rear-firing Weapons:** Do not add damage for rear-firing weapons.

**Pulse Lasers/Targeting Computers:** Increase damage for pulse lasers and targeting computer-linked weapons by 10 percent. These bonuses are cumulative; for example, add 20 percent for a pulse laser that is linked to a targeting computer.

**Missiles:** For missile launchers, use the damage inflicted by an average missile hit roll (a result of 7 on the Missile Hits Table; a roll of 9 on the table if the launcher has Artemis IV or the unit has a Narc missile beacon; the equivalent of a result of 12 for Streak launchers). Do not include damage for single-shot (OS) launchers.

**Ultra Autocannons:** Multiply the damage done by 1.5.

**Ammunition:** If an ammo-using weapon does not have enough ammunition to fire for at least ten turns, reduce the overall damage of the weapon by 25 percent.

### Heat

Find the total heat generated by firing all weapons and add to that number the heat for maximum movement (either 2 Heat Points for Running or the Heat Points generated by the unit's maximum jump if the unit has Jumping MP). Then subtract 4 from the total. If the total heat minus 4 is greater than the amount the unit's heat sinks can dissipate (doubling the heat

# APPENDICES

dissipated for double heat sinks), adjust the base damage as follows. Multiply the total base damage by the unit's heat sinks (double the second number if the unit has double heat sinks). Divide the result by the unit's maximum heat output minus 4. Round the result normally. The final result is the heat-modified damage.

The following special cases apply to heat calculations.

**Rear-firing weapons:** Do not include heat for rear-firing weapons.

**Jumping:** Do not include heat generated by jumping if a unit's **BattleTech** statistics show a Jump MP lower than its Walking MP.

**Missiles:** Do not include heat for single-shot (OS) launchers.

**Ultra Autocannon:** Add double heat for Ultra ACs.

## Final Damage Values

Divide the heat-modified damage by 10 (rounding normally) to find the **BattleForce** Damage Value at each range.

## SPECIAL EQUIPMENT AND ABILITIES

The final Damage Values may confer the following special abilities and equipment on an element.

**Indirect Fire:** If at least half of the unit's long-range damage comes from LRMs, give that element the indirect fire (if) ability.

**Artillery:** If more than half of the unit's long-range damage comes from artillery weapons, give it artillery (art). Note the type of artillery: Long Tom (L), Sniper (S), Thumper (T) or Arrow IV (A). If the unit carries several types of artillery, the type used for this purpose is the one that inflicts the most damage.

## OVERHEAT VALUE

If an element can overheat (as determined in the **Heat** step, p. 101), it may have an Overheat Value. Re-figure the damage at each range without factoring in heat, to find the maximum possible damage. If the element's **BattleForce** damage at medium range is higher when heat modifications are not applied, it can overheat in **BattleForce**. An element's Overheat Value is equal to the maximum medium range damage minus the normal (adjusted for heat) medium range Damage Value, to a maximum of 4.

If the unit has no medium range Damage Value, apply this process to pointblank damage instead.

## POINT VALUE

Each element's Point Value in **BattleForce** derives directly from its Battle Value, divided by 100. Battle Values are a point system for rating **BattleTech** units. The rules for generating Battle Values are beyond the scope of this product, but appear in the **Maximum Tech** advanced rulebook.

## CONVERTING BATTLEFORCE TO BATTLETECH

Players can convert damaged **BattleForce** elements back to **BattleTech** terms in order to make repairs or play out segments of the game at **BattleTech** scale. These conversions are useful for campaign play, or when making repairs using the **Scavenging and Repair** rules on page 94 of the **BattleTech Compendium: The Rules of Warfare** or page 56 of **Maximum Tech**.

Elements considered destroyed in **BattleForce** are not necessarily destroyed in **BattleTech**. Therefore, players wishing to play at **BattleTech** scale or make repairs should convert each destroyed as well as each damaged element according to the following rules to determine if the element is destroyed in **BattleTech** terms. To convert an element from **BattleForce** to **BattleTech** terms, players will need a copy of the unit's **BattleTech** record sheet.

Because the conversion rules represent an approximation at best, each conversion results in a loss of detail, and so we recommend that players do not convert units back and forth between **BattleForce** and **BattleTech** more than once. In general, conversions should be handled as follows. Convert a **BattleTech** unit to **BattleForce** and use it to play **BattleForce**. When you want to shift to **BattleTech** scale, convert it back to **BattleTech** terms. Play it in **BattleTech** for as long as you want, but repair it before converting it back to **BattleForce** terms. It is easier to accurately convert a repaired unit back to **BattleForce** terms for a new fight.

## Armor

If a **BattleForce** element has suffered armor damage, that damage will be randomly converted to **BattleTech** terms. For each point of **BattleForce** armor damage the element has suffered, apply 30 points of **BattleTech** damage in 5-point groups (as if it were standard LRM damage). This damage does not harm the element's internal structure or inflict critical hits. Damage that would normally have affected the internal structure transfers per the Damage Transfer Diagram (p. 41, **BTC: RoW**) to the next armor location inward.

## Structure

Structure damage is converted similarly to armor damage, but only after all armor damage has been converted. For each point of **BattleForce** structure damage the element has suffered, apply 20 points of **BattleTech** damage in 5-point groups. This damage affects armor and structure, just like normal **BattleTech** damage. However, it cannot inflict critical hits unless the element was destroyed in **BattleForce** terms (all of its structure boxes crossed off on the record sheet). If the element was destroyed, check for critical hits per standard rules upon conversion. Otherwise, apply critical hits according to the rules below.

## Critical Hits

If a **BattleMech** element suffered **BattleForce** critical hits, convert those hits directly to **BattleTech** terms even if the element was subsequently destroyed in **BattleForce** terms. This does not apply to other types of elements.

Most of the effects of these critical hits are applied at random. To determine the specific slot that suffers a critical hit, roll repeatedly on the **BattleMech** Hit Location Table (p. 39, **BTC: RoW**) until the result indicates a location that contains the appropriate item. Then roll for a critical hit in that location repeatedly until the result indicates a hit on an appropriate slot. Apply the critical hit to that slot only.

**Arm Actuator Hit:** One arm, shoulder or hand actuator is hit at random.

# APPENDICES

**Leg Actuator Hit:** One leg, hip or foot actuator is hit at random.

**Weapon Destroyed:** One critical hit is applied to a weapon, determined at random.

**Engine Hit:** One critical hit is applied to the engine, determined at random.

**Head Blown Off:** The 'Mech has suffered a "head blown off" critical hit.

## CONVERTING BACK TO BATTLEFORCE

Damaged **BattleTech** units can be converted to **BattleForce** terms in the same way as converting custom units. Use the actual amount of armor remaining after damage instead of the unit's original Armor Factor. If the unit suffered any critical damage, convert this damage into **BattleForce** terms, as described below.

### Ammunition

Do not count lost ammunition when calculating how many shots each ammo-using weapon can fire. If a weapon has no ammo, do not count the damage it would normally do when figuring **BattleForce** Damage Values.

### Arm/Shoulder/Hand Actuator

If weapons are mounted in the affected arm, treat the unit as though it has suffered one **BattleForce** arm actuator critical hit for every two damaged actuators.

### Arm Destroyed

Do not count weapons and equipment in the destroyed arm when figuring **BattleForce** Damage Values. Each arm lost also reduces by half the addition to the pointblank Damage Value for physical attacks.

### Engine

Each engine critical hit converts directly to one **BattleForce** engine critical hit.

### Gyro

One gyro hit converts to a **BattleForce** leg actuator critical hit. If the unit's gyro has been destroyed, that unit has zero MP when converted to **BattleForce**.

### Heat Sinks

Do not count destroyed heat sinks when calculating heat modifications for **BattleForce** Damage Values.

### Jump Jet

Because an element only has Jumping MP in **BattleForce** if its **BattleTech** Jumping MP is equal to or greater than its Walking MP, the loss of even a single jump jet is enough to eliminate the unit's **BattleForce** jump capability.

### Leg/Hip/Foot Actuator

Use the unit's modified MP when calculating **BattleForce** MP.

### Leg Destruction

A unit with a destroyed leg has only 1 MP in **BattleForce**. A unit with both legs destroyed has 0 MP.

### Life Support

Reduce the element's Overheat Value by 1 if it has suffered a life support critical hit. If the unit has no Overheat Value, the critical hit has no effect in **BattleForce** terms.

### Sensors

Convert a single sensors critical hit to a **BattleForce** arm actuator critical hit. If the unit suffered two sensors critical hits, it cannot fire weapons. In that case, the only damage it can do is physical attack damage at pointblank range.

### Weapons

If a weapon is destroyed, do not add the damage it can do to the total damage when figuring **BattleForce** Damage Values.

## APPENDIX II: BATTLESPACE CONVERSIONS

The **BattleForce** statistics for each aerospace fighter and DropShip derive directly from their **BattleSpace** statistics. The **BattleForce Roster** (p. 118) contains pre-generated **BattleForce** statistics for all **BattleSpace** fighter and DropShip forces published as of the printing of this game (December 1997). Future **BattleTech** products that contain new **BattleSpace** units will also provide **BattleForce** conversions for them. JumpShips and WarShips are beyond the scope of **BattleForce**, though they are part of the **Planetary Assault** game. The following rules explain how to convert your own fighter and DropShip designs into **BattleForce** terms.

To make the conversion, start with the unit's **BattleSpace** statistics.

### MOVEMENT

A unit's **BattleForce** MP equals its **BattleSpace** Safe Thrust Rating.

### ARMOR AND STRUCTURE

Armor and structure are converted differently for fighters and DropShips, as described below.

#### Fighters

A fighter's **BattleSpace** Armor Value becomes its **BattleForce** Armor Value. In **BattleForce**, fighters have only armor and no structure, similar to infantry elements.

#### DropShips

To find a DropShip's armor and structure, first add up the **BattleSpace** Armor Values on all four hit locations (Fore, Right Side, Left Side and Aft). Divide this total by 3, rounding normally. Then divide the resulting number as equally as possible between **BattleForce** armor and structure, adding any odd points to the Armor Value.

### DAMAGE VALUES

Damage Values for **BattleSpace** units are converted in a manner similar to **BattleTech** forces, except that the final heat-adjusted damage is not divided by 10 because **BattleSpace** fire factors are already equivalent to 1/10th of **BattleTech** damage. Follow the instructions for **BattleTech** conversions except as noted below.

# APPENDICES

## Fighters

First add up the **BattleSpace** fire factors at each range for Nose, Right Wing and Left Wing weapons. The results become the fighter's base **BattleForce** Damage Values.

Next, add up all heat listed for Nose, Right Wing and Left Wing weapons and subtract 4 from the result. Compare this number to the fighter's total heat sinks (double the latter number if the sinks are double heat sinks). If more heat is generated than the sinks can dissipate, reduce the fighter's Damage Values at each range in the same way as for **BattleMech** elements. Fighters may overheat like 'Mechs, and their Overheat Values are calculated the same way.

Remember to make any applicable adjustments for special equipment, in the same way as for **BattleTech** units.

## DropShips

Convert the **BattleSpace** short-, medium- and long-range fire factors to pointblank, medium and long ranges in **BattleForce**. Each DropShip has two sets of Damage Values: in the case of spheroid ships, one is for the right side and one for the left side. (On the record sheet, the second set of numbers goes under the first, where the heat scale is for 'Mechs.) Aerodyne DropShips also have two sets of numbers, but both apply to attacks into the front firing arc.

**For spheroid DropShips:** First, add up the **BattleSpace** fire factors at each range for FR and AR weapons. These numbers become the Right Side base Damage Values. Do the same for FL and AL weapons to find the Left Side base Damage Values. Next, add up all heat listed for FR, AR, FL and AL weapons and subtract 4 from the total. Compare that number to the ship's total Heat Sinks (double the latter number for double heat sinks). If more heat is generated than the sinks can dissipate, reduce the Damage Values at each range.

**For aerodyne DropShips:** First, add up the **BattleSpace** fire factors at each range for Nose, RW and LW weapons. Divide the total by 2. The results become the ship's base Damage Values. Next, add up all heat listed for Nose, RW and LW weapons and subtract 4 from the total. Compare the result to the ship's total Heat Sinks (double the latter number for double heat sinks). If more heat is generated than the sinks can dissipate, reduce the base Damage Values at each range.

Remember to check for indirect fire and artillery capability, as well as other applicable special equipment. Unlike fighters, DropShips have no Overheat Value.

## APPENDIX III: INTEGRATION

This section offers guidelines for using **BattleTech**, **BattleSpace**, **BattleForce** and **Planetary Assault** together as an integrated game system.

### PLANETARY ASSAULT

Rather than using the battle board and basic **Planetary Assault** rules, players may play out a **Planetary Assault** battle at **BattleForce** scale or, for the truly ambitious, at **BattleTech** scale, for greater depth and detail in combat resolution. Space battles can likewise be resolved using **BattleSpace** rules.

First, determine what **BattleForce**, **BattleTech** or **BattleSpace** units are on each side. Then set up the mapsheets for the appropriate game and resolve the combat according to that game's rules. The rules below assume that a

**Planetary Assault** battle is being resolved using **BattleForce** rules, but players can use the same process for **BattleTech** and **BattleSpace**.

Every **Planetary Assault** battle need not be resolved at **BattleForce** or smaller scales. In fact, players will likely find their games more fun if they resolve only the most pivotal battles in this way. For example, players might choose to resolve all combat involving each side's commanding officer's unit using **BattleForce**, while resolving others on the battle board using **Planetary Assault** rules. The choice depends on the players and the time available.

Because each **Planetary Assault** turn represents two days while each **BattleForce** turn represents 30 seconds, any number of **BattleForce** turns can be played within a single **Planetary Assault** turn.

### Forces

All the units in the battle hex must be converted to **BattleForce** terms, meaning that the exact composition of every 'Mech and vehicle company, fighter squadron and so on must be determined. If the players do not have this information immediately available, they may randomly generate appropriate forces.

Convert each **Planetary Assault** unit to **BattleForce** terms by generating all of each unit's elements using the Unit Generation Tables on p. 58. Alternatively, players may use the Unit Generation section from any appropriate **BattleTech Field Manual**. Players should keep track of which **Planetary Assault** unit each **BattleForce** unit came from, so that they can convert the units back to **Planetary Assault** appropriately.

### Setup

Each battle is played on the standard **BattleForce** mapsheets, unless the players have additional **BattleTech** mapsheets available. If so, players may select any appropriate maps to represent the terrain on the planetary map on which the battle is taking place. Players can also use the rules for selecting mapsheets from the **Creating Scenarios** section of any **BattleTech Field Manual** or from **First Strike!** to establish the playing area.

If a settlement is in the battle hex, then players should place buildings of the appropriate type on the map. The placement of the buildings is up to the player who controls the settlement (normally the defender).

### Playing the Game

After establishing terrain and forces, the players play out the battle as a standard **BattleForce** scenario (see p. 52).

### Returning to Planetary Scale

Once the **BattleForce** scenario ends, the surviving units must regroup into **Planetary Assault** units. After the battle is over, damage is irrelevant. The only thing players must keep track of are destroyed elements within the units. Placement of units on the planetary surface map is handled in the same way as returning units to that map from the battle board after a standard **Planetary Assault** battle. Any units on the support map at the end of the scenario are considered to have fled the battlefield.

For units that have weight classes—**BattleMech**, ground vehicle and fighter units—resolve damage as described in the

# APPENDICES

following paragraphs. All other units are considered destroyed if they lose more than 50 percent of their component elements. Units that are not destroyed return to play as if undamaged.

If a unit loses 25 percent or less of its component elements (for example, three or fewer 'Mechs or vehicles in the case of a company), it is considered undamaged in **Planetary Assault** terms. The unit returns to play normally.

Any **Planetary Assault** unit that lost more than 25 percent of its component elements will be destroyed or have its weight class reduced to represent the damage it took. Reference the original weight class of the **Planetary Assault** unit against the percentage of its **BattleForce** elements that were destroyed. The result is the unit's new **Planetary Assault** weight class. On a "destroyed" result, the unit is removed from play.

For example, a **Planetary Assault** Heavy 'Mech company consists of twelve elements at **BattleForce** scale. During the battle, five of these elements are destroyed. This number represents approximately 42 percent of the company's 'Mechs. As indicated on the Planetary Assault Conversion Table, losses of 26 to 50 percent for a Heavy unit reduce the unit's weight class to Medium. If the unit had lost eight elements (67 percent of its total number), its weight class would be reduced to Light. For convenience, the most common unit types are shown on the table.

The reduction of a unit's weight class does not constitute an actual change in the nature of the unit's component elements. Once a **Planetary Assault** unit has been converted to **BattleForce** or **BattleTech** scale, players should keep the record sheets for that unit on hand in case it returns to **BattleForce**- or **BattleTech**-scale combat later in the game. If the unit does return to such combat, use those record sheets, with the damage from the previous battle marked on them, rather than converting the unit all over again. After subsequent battles, compare the unit's losses based on its original size and weight class to determine if its weight class is further reduced by damage.

## BATTLEFORCE

While it is technically possible to resolve combat in a **BattleForce** game using **BattleTech** rules, shifting from one set of rules to the other is incredibly cumbersome in most cases. Therefore, the following rules only cover duels, in which the rest of a battle is suspended while two 'Mechs or two units engage in single combat. This minimizes the complexity of converting units back and forth from **BattleForce** to **BattleTech** terms.

### PLANETARY ASSAULT CONVERSION TABLE

Unit Type	Elements Destroyed			
	0-1	2-3	4	5+
Squadron (6)	0-1	2-3	4	5+
Binary or fighter Star (10)	0-2	3-5	6-7	8+
Company (12)	0-3	4-6	7-9	10+
Trinary (15)	0-3	4-7	8-11	12+
Original Weight Class	Losses			
	0-25%	26-50%	51-75%	76%+
Assault	Assault	Heavy	Medium	Destroyed
Heavy	Heavy	Medium	Light	Destroyed
Medium	Medium	Light	Light	Destroyed
Light	Light	Light	Destroyed	Destroyed

## Invoking BattleTech

If both players agree, they can "invoke" **BattleTech** scale in the End Phase of any turn. One hex on the **BattleForce** map is nominated as the center of the **BattleTech** playing area. All units in that hex, as well as any units within three hexes of it, may be involved in the **BattleTech** game. **BattleForce** play is suspended temporarily while players set up the **BattleTech** map.

At the players' choice, any units in the playing area can be excluded from the **BattleTech** combat if they are not involved in the duel. Players need not convert these units, and must move them out of the dueling area on the **BattleForce** map as soon as possible.

## Game Setup

The **BattleTech** play area consists of two mapsheets. Use any appropriate mapsheets based on the terrain of the area in which the battle will take place. The mapsheets are placed with their long edges joining, as shown below.

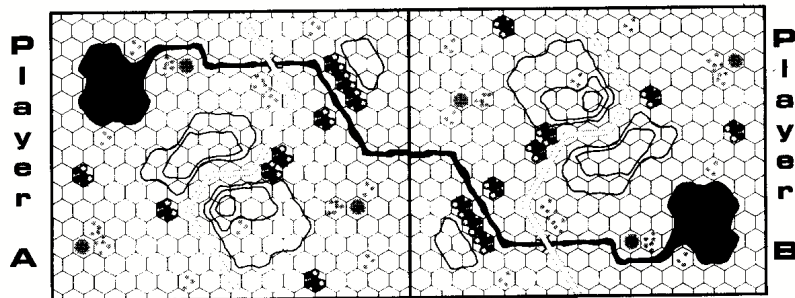

Units involved in the **BattleTech** combat must be converted to **BattleTech** scale using the **BattleTech Conversion** rules (p. 100) if they are damaged. If they are undamaged, simply use the appropriate **BattleTech** record sheets to represent each unit or element.

Each player rolls 2D6. The player who rolled highest chooses one mapsheet as his home mapsheet. He places any of his units that occupied the chosen hex on the **BattleForce** map in any full hexes, with any desired facing. The other player then places any of his units that occupied the chosen **BattleForce** hex on the other **BattleTech** mapsheet.

During the Movement Phase of Turn 1, any units within three hexes of the chosen **BattleForce** hex move onto the **BattleTech** map via the edge of each player's home mapsheet. These edges are marked on the sample map above as "Player A" and "Player B."

## Playing the Game

While the duel is taking place, no units may fire at the **BattleTech**-scale units involved, and no new units may move to within a three-hex radius of the chosen **BattleForce** hex. Likewise, units that leave the

# APPENDICES

**BattleTech** mapsheets cannot re-enter **BattleForce** play until the duel is over.

Each **BattleForce** turn comprises three turns of **BattleTech**. This means that the first three turns of **BattleTech** are played before **BattleForce** play resumes.

After three **BattleTech** turns, **BattleTech** play is suspended while one **BattleForce** turn is played. After the **BattleForce** turn, three more **BattleTech** turns are played. Repeat this cycle until the duel is resolved. The duel ends when all of one player's **BattleTech** units are either destroyed or have left the **BattleTech** map.

## Returning to BattleForce Scale

Once the duel is over, players must convert the surviving **BattleTech** units back to **BattleForce**-scale elements. Then they may resume normal **BattleForce** play.

## USING BATTLETECH FIELD MANUALS

Players can easily generate forces that accurately represent any of the famous (or infamous) units in the **BattleTech** universe using the Unit Rosters in any of the **BattleTech Field Manual** series. The following simple guidelines allow players to pit the elite First Sword of Light against Zeta Battalion of Wolf's Dragoons, or create any other unique confrontation they may desire.

Because these are guidelines rather than hard-and-fast rules, the players must use them according to their best judgment to receive the best results in terms of fair play and enjoyment.

## BattleForce

Because **BattleForce** uses the same battlefield units that **BattleTech** does (just more of them), players can simply use the Unit Generation tables found in a **Field Manual** to create each **BattleForce** BattleMech unit. For vehicles and aerospace fighters, use the table on p. 61 of this book.

## Planetary Assault

To convert a unit from a **Field Manual** into **Planetary Assault** terms, players must know the unit's size, experience level and equipment ratings. Create the appropriate number of company types randomly using the Random Weight-Class Table in the **Field Manual**'s Unit Generation rules. Players can adjust these based on the text of the specific **Field Manual** regarding unit composition. For example, if a regiment is described as including an assault company, then by all means include one even if such a company is not randomly generated.

The experience level of each **Planetary Assault** unit larger than a company is equal to the overall experience level given to the unit in the **Field Manual**. Within larger formations such as battalions and regiments, the experience level may be subject to some variation if players so desire. As a guideline, players may designate one company as the formation's command company. That company has an experience level one higher than the overall level listed in the **Field Manual**. Players should also choose a "rookie company" and lower its experience level by one; such a company is usually Light. In all cases, however, the maximum experience level is Elite and the minimum is Green.

An Inner Sphere unit's Equipment Rating determines whether its elements are considered to have standard or

upgraded technology. Units with Equipment Rating A frequently even contain elements equipped with Clan technology. Among the Clans, a unit's status as front-line or second-line determines its technology. In the case of second-line forces, some units have Inner Sphere standard technology, which represents their limited access to equipment and munitions.

The Technology Conversion Table summarizes the conversion from Equipment Rating or Clan unit status to **Planetary Assault** technology levels. The indicated percentage is the amount of forces of each type within the unit. For example, a typical 'Mech regiment contains ten companies. Such a regiment with Equipment Rating B contains eight companies (80 percent) with Inner Sphere upgraded technology and two companies (20 percent) with Inner Sphere standard technology.

## TECHNOLOGY CONVERSION TABLE

Equipment Rating	Standard	Upgraded/Clan Second-Line	Clan Front-Line
A	—	80%	20%
B	20%	80%	—
C	40%	60%	—
D	60%	40%	—
F	100%	—	—
Clan Front-Line	—	20%	80%
Clan Second-Line	20%	60%	20%

## APPENDIX IV: CAMPAIGNS

If they wish, players may play a campaign: multiple games of **BattleForce** and/or **Planetary Assault** played one after another using a fixed force on each side for the entire campaign. Using the appropriate conversion rules (p. 100, 103), players can also link **BattleTech** and **BattleSpace** games into a **BattleForce** or **Planetary Assault** campaign. In a campaign, each side's commander must dictate his forces' overall strategy in order to outmaneuver his opponent and gain the upper hand. In contrast to the short-term victories achieved in **BattleTech**, a player in a **BattleForce 2** campaign can lose the battle, but win the war.

The easiest way to link **BattleForce** games into a campaign is to use **Planetary Assault** to represent the strategic movement of forces. When **Planetary Assault** units meet in battle, use the **BattleForce** rules to resolve combat as described in **Integration** (p. 105). This type of campaign is described below.

Players can also link **BattleForce** games in a more abstract manner. The exact execution of such a campaign is up to the players to work out.

A typical short campaign might consist of three games: a Meeting Engagement, an Initial Assault and a Final Battle. In the Meeting Engagement, only the Light and Medium units from each side, along with aerospace fighters, are involved. The winner of the Meeting Engagement becomes the attacker in the following two scenarios. In the Initial Assault, both players may use all their forces, though they may wish to keep some in reserve to use as reinforcements in the Final Battle. The winner of the

# APPENDICES

Initial Assault scenario receives the benefit of a +2 modifier to Initiative rolls during the Final Battle scenario, and may also choose the side of the map through which his forces enter play.

For added realism and complexity, players may use any or all of the following options: **Scavenging and Repair**, **Double-Blind Play** and **Interstellar Campaigns**.

## SCAVENGING AND REPAIR

After each battle in a campaign, technicians can repair and re-arm damaged elements before the next battle begins.

If using the **Planetary Assault** game as a campaign framework, players make Repair Rolls in the End Phase of the **Planetary Assault** turn sequence. Otherwise, Repair Rolls are made between **BattleForce** games.

The **BattleForce** Repair Table, p. 108, summarizes the repair process. The base target number for each repair attempt is based on the unit's technical support—not an official designation, but an overall description of the unit's technical abilities and available supplies. Unit descriptions in the **BattleTech Field Manuals** give an overall impression of technical support. If players have no **Field Manual** available, or the book does not indicate technical support for the unit in question, base the unit's technical support on its Experience Level, as shown on the Repair Table.

Apply modifiers to the target number for the repair roll as shown on the table. Modifiers for terrain are based on the **Planetary Assault** hex occupied by the element being repaired. Each MASH element can only aid in the repair of one infantry unit per **Planetary Assault** End Phase. See **Salvage** and **Destroyed Elements** for additional explanations of modifiers for salvage and element destruction.

To make the repair attempt, roll 2D6. If the result is equal to or greater than the modified target number, the repair is successful.

For every point by which the result equals or exceeds the target number, the player may repair his choice of one of the following: 2 Armor Points, 1 Structure Point or one critical hit. For example, if the modified Target Number is 8 and the player rolls a 10, he can make three repairs: one for 8, one for 9 and one for 10. He might choose to repair 4 Armor Points and 1 Structure Point, one critical hit and 2 Structure Points, or any other combination. These results can only be applied to the target elements; the player cannot split them with other elements. Excess repairs that cannot be made to the target element are lost.

A player may make only one repair attempt per damaged element per **Planetary Assault** End Phase. If the attempted repair roll fails, the player may not attempt another repair roll on the same element until the End Phase of the next **Planetary Assault** turn. Players may not carry over unused repair attempts to other elements.

## Destroyed Elements

An element destroyed by the loss of all of its structure is not necessarily literally destroyed. In order to save such a unit, however, its controlling player must repair it immediately after the battle in which it was destroyed. Always make Repair Rolls for destroyed elements before repairing other elements.

Apply a +4 modifier to the target number for repairing a destroyed element. If the Repair Roll fails, the unit is destroyed for good, though it may be used for salvage to aid in the repair of other elements. If the roll succeeds, the element is repaired

as described above, except that the player must apply the first repair to the internal structure.

An element destroyed by having its head blown off, its crew killed or by taking three engine critical hits can be saved in the same way, except that the player must apply the first repair to the critical hit that destroyed the element rather than to its internal structure.

## Salvage

After a typical battle, the ground is littered with destroyed 'Mechs and vehicles that can be scavenged for spare parts. Having salvage available always makes repair attempts easier. Salvage rules do not apply to infantry elements.

Only the side that claimed the battlefield can use salvage after a scenario. This is usually the winner, but not always. For example, if the winning side moved off the edge of the map (as in a chase scenario), then it cannot use salvage because it left behind the destroyed 'Mechs and vehicles.

The player who claims the battlefield takes all salvage, from his own side and his opponent's. Players may not, however, salvage units that were destroyed on the enemy's side of the support map. Opposing destroyed elements may not be repaired. The player should, however, attempt to repair friendly destroyed elements before using them as salvage (see **Destroyed Elements**).

Each destroyed element can be used as salvage to help repair one element of the same type. 'Mech salvage can only be used to repair damaged 'Mech elements, vehicle salvage to repair vehicle elements, and aerospace salvage to repair aerospace elements.

Available salvage applies a modifier to the Repair Roll target number. If the technology base of the salvage matches that of the element to be repaired (Clan for Clan or Inner Sphere for Inner Sphere), the modifier is -3. If the technology base does not match, the modifier is -1.

In addition, if a repair attempt with non-matching salvage is successful, the Damage Values of the repaired unit are altered. These changes are only made once, even if an element is later repaired again with non-matching technology. When Inner Sphere salvage is used to repair a Clan element, reduce all of the element's Damage Values by 1. (A 'Mech element's point-blank Damage Value cannot be reduced below 1 in this way.) When Clan salvage is used to repair an Inner Sphere element, increase all of the repaired element's Damage Values by 1. However, the repair will not add Damage Values to ranges at which the element could do no damage before.

Salvage is expended after a single repair attempt, whether successful or not.

## Technicians

Technicians are the people who perform the repairs on damaged elements. For the purposes of **BattleForce** campaigns, "technicians" refers to all personnel involved in any kind of repair work, including vehicle mechanics, aerospace engineers and even the doctors who "repair" damaged infantry elements.

Unless the players are playing with units they have created, assume that both players have enough technicians to cover their needs. The standard technical support modifier based on each element's experience level, shown on the **BattleForce** Repair Table, represents this coverage.



# APPENDICES

If the unit has a complete description, such as a mercenary unit created using the rules in the **BattleTech Field Manual: Mercenaries**, then specific Technician Skill numbers replace the base target number given on the table.

## Limited Supply

If the players want an additional challenge, each side can be assigned a limited amount of supplies, restricting their ability to repair units after battle. Supply Points represent the amount of supplies available. Each side starts a campaign with a fixed number of Supply Points—an equal amount for both players, with more points for a longer campaign. In a typical campaign lasting for three to five games, the number of Supply Points is equal to the total number of elements on both sides. For example, if Player A has 20 elements and Player B has 18 elements, both sides would start the campaign with 38 Supply Points. This number represents enough supplies to perform many repairs, but if a player exhausts it too early, he will have none left for the final battles.

Each time a player attempts a Repair Roll, he spends 1 Supply Point. He can use additional supplies in order to expedite the repairs; each extra Supply Point spent adds 1 to the result of the Repair Roll. The player must decide on a number of Supply Points to be spent on a particular element before making the Repair Roll.

A salvage element of the appropriate type counts as 1 Supply Point when used to aid repairs as described in **Salvage**.

## DOUBLE-BLIND PLAY

With the addition of a second planetary map and a referee, players can play double-blind campaigns. In a double-blind game, each player has his own map on which he sets up only his own units. Neither player can see enemy units until a unit from his own side detects them.

The referee should keep track of each player's movement on a copy of the planetary map. Players can use a photocopy of the map on p. 73, or the referee can set up a third planetary map with both players' units on it. Only the referee knows where all units are at any given time.

## Unit Detection

The referee must watch each unit's movement carefully. If a unit enters a hex containing an enemy unit, that unit is detected. The moving unit must end its movement if it is a ground unit. An air unit can continue moving after detecting an enemy unit.

Aerospace units in orbit can scan one hex per turn during the End Phase. The controlling player nominates one hex in the area of the planet's surface corresponding to the orbit zone his unit occupies. Any enemy units in the nominated hex are detected.

When a player detects an enemy unit, a counter for that unit is placed face-down on the detecting player's map. The unit can be reconned after that point (see **Reconnaissance**, p. 81). It stays on the detecting player's map as long as he has units in the same hex or in a hex adjacent to it, or has aerospace units in the orbit zone above it. If these conditions are not met, the unit counter is removed from the detecting player's map in the End Phase of the current turn, and the player must detect the enemy unit again later. A newly detected unit is always placed face-down even if an opposing player detected it previously.

## INTERSTELLAR CAMPAIGNS

Players can run massive campaigns spanning dozens of worlds using the map of the Inner Sphere contained in this box. In an interstellar campaign, the strategic movement of troops on JumpShips becomes a major factor, as each JumpShip must spend a week recharging after a jump before it can make another jump.

The following guidelines should get players started on an interstellar campaign. The guidelines are only intended as a rough framework, however. Ambitious players can expand on the basics given below with additional rules from other **BattleTech** products, such as **Maximum Tech** and **MechWarrior, Second Edition**, as well as adding their own personal rules to the mix.

An interstellar game is most realistically played under double-blind conditions, with a referee keeping track of the positions of each player's JumpShips and troops. If both players know where the other player's troops are headed, it is relatively simple to intercept them. In the case of interstellar movement, a player detects enemy JumpShips only if he has units in the planetary system when an enemy JumpShip arrives, or if he moves one of his own JumpShips into a system occupied by an enemy JumpShip or WarShip. Enemy units on the planetary surface cannot be detected by ships at a jump point, though arriving JumpShips are detected by units on the surface.

Throughout these guidelines, the term "JumpShip" is used to describe any jump-capable craft, including WarShips. If a particular rule only applies to one or the other class of vessel, the rules will specify which.

## Strategic Turns

The interstellar campaign is played in a series of strategic turns, each of which represents a week of real time. During each strategic turn, three **Planetary Assault** turns take place. The strategic turn sequence is summarized below.

### Strategic Turn Sequence

1. JumpShip Movement
2. Planetary Assault Turn 1
3. Planetary Assault Turn 2
4. Planetary Assault Turn 3
5. Strategic End Phase

### JumpShip Movement and Recharging

A JumpShip can move up to thirty light years in a single hyperspace jump, as shown on the Inner Sphere map. Measure the JumpShip movement distance on the Inner Sphere map.

A JumpShip with a charged jump drive can make a single jump of up to thirty light years in any direction. After a jump, a JumpShip must recharge its jump drive using a solar collector called a jump sail. This process takes a variable amount of time—about a week on average. For purposes of these rules, recharging always takes one strategic turn. This means that each JumpShip can move once per strategic turn.

A JumpShip equipped with a lithium-fusion (LF) battery can store the battery's energy for an additional jump, allowing such vessels to move twice in a single JumpShip Movement Phase. Alternatively, a player can save this additional jump for later in that same turn to allow the JumpShip to leave the System

# APPENDICES

Diagram in case a quick retreat is required. Extra jumps cannot be saved from one turn to another. LF batteries take the same amount of time to charge as a jump drive, and so an LF-equipped JumpShip can move twice every strategic turn.

If the specific model of a vessel or its **BattleSpace** statistics are not available, assume that all WarShips are equipped with LF batteries and that standard JumpShips are not.

Only inhabited star systems are marked on the Inner Sphere map. Unmarked systems exist as well, which can be useful places to recharge jump drives away from an enemy's eye. Because these systems are not well charted, however, a JumpShip risks a mis-jump each time it moves into one of these systems.

Players can assume that enough unmarked systems exist to enable them to jump to any desired point on the map. To jump to an unmarked system, mark the ship's position on the map with a pencil mark or a pin. Then roll 2D6. On a result of 2, the ship has mis-jumped and the player must roll 2D6 again. On a second result of 2, the ship is lost and all units aboard it are destroyed. On any other result for the second roll, the ship has suffered drive damage and cannot move in the following strategic turn while repairs are made.

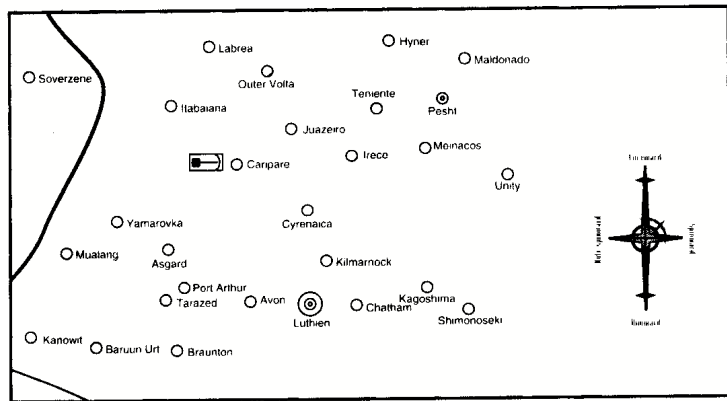

*The JumpShip in the diagram starts the interstellar turn in the Caripare system. It can reach the Itabaiana, Outer Volta, Juazeiro or Cyrenaica systems in a single jump. To reach Asgard, the ship would have to make two jumps—one into an unmarked system and a second to the Asgard system. Completing this move would take two strategic turns, unless the ship has a lithium-fusion battery. Jumping into an unmarked system requires a 2D6 roll to see if the ship mis-jumps or the drive fails.*

**Note:** Due to a typographical error, some of the planet "dots" shown in this section of space do not appear on the Inner Sphere map. The correct positions of these planets appear in the diagram.

## Strategic End Phase

During the End Phase, players may deal with supplies if they wish to include them in their campaign. Otherwise, play continues until one player achieves victory for the campaign. The players set specific victory conditions by mutual consent;

## BATTLEFORCE REPAIR TABLE

Unit Technical Support*	Base Target Number
Excellent (Elite)	7
Good (Veteran)	8
Average (Regular)	9
Poor (Green)	11
None	12
Condition	Modifier
Element has been destroyed	+4
Salvage available:	
Same technology	-3
Different technology**	-1
Working conditions:	
Friendly base	-1
Friendly city or fortress	-2
Arctic, Mountain or Ocean terrain	+2
MASH element available (Infantry only)	-2

\*If a unit has a specific Technician Skill, use that number as the base target number.

\*\*A successful repair changes the element's Damage Values; see **Salvage**, p. 107.

Salvage modifiers do not apply to infantry repairs.

generally, victory involves seizing a certain number of the enemy's planets.

See **Limited Supply**, p. 108, for rules on how to use supplies in **BattleForce** campaigns. In an interstellar campaign, each planet controlled by the players produces a certain number of Supply Points. The number of planets involved on both sides should be equal at the start of the campaign.

The players determine the exact number of Supply Points generated by each planet; these points are generated in the End Phase of every strategic turn. As a guideline, most planets provide a number of Supply Points equal to the total number of **Planetary Assault** units with which the side that controls it started the game, times 10. Provincial and district capital worlds (marked with two concentric circles on the map, such as Benjamin) generate twice as many Supply Points. Successor State capitals (marked with three concentric circles on the map, such as Luthien) generate three times as many Supply Points.

Supply Points generated by each planet can be used by forces on that planet or forces elsewhere. However, in order for forces elsewhere to use them, the supplies that the points represent must be moved via JumpShip. To do this, the moving player notes how many points are "loaded" onto a JumpShip from the planet's system. When that JumpShip arrives in the system occupied by the units for which the supplies are intended, simply add the points carried to the target system's total points.

This supply system is intentionally abstract. Supplies represented by these points need not be transported to the surface of the planet via DropShips, nor do they take up any space on the ships transporting them. If a JumpShip carrying supplies suffers a mis-jump, those Supply Points are lost.

## TECHNICAL READOUT

The following section contains a general description of the workings of a BattleMech, a list of the most common BattleMech equipment and weapons, and a sampling of the many machines of war that exist in the **BattleTech** universe. While this information has no bearing on the **BattleForce** game, it does provide useful background on the elements and units used in the game. The 'Mechs, fighters, vehicles and so on listed represent only a fraction of the forces available; for complete information, see **Technical Readouts 3025, 3050, 3055, 3057 and 3058.**

### THE BATTLEMECH

—From a promotional pamphlet distributed by Skobel Mechworks of Terra

#### THE FIRST

In 2439, the introduction of a lethal new weapon revolutionized modern warfare forever. That weapon was the first BattleMech—the MCK-5S *Mackie*. Though the *Mackie* would be considered primitive by today's standards, the machine represented the most advanced battlefield technology of its day. Now, six hundred years later, Skobel MechWorks is proud to commemorate the birth of the *Mackie*, the ancestor of all modern BattleMechs, with this free pamphlet.

#### THE MODERN BATTLEMECH

The modern BattleMech is perhaps the most complex machine ever produced. Each 'Mech contains thousands of different components, far too many to explain here. But exploring the systems and the capabilities of BattleMechs is a great way to start getting to know these marvelous machines.

#### Skeleton

Every BattleMech contains a "skeleton" made up of several dozen "bones." Each "bone" is a honeycombed, foamed-aluminum core wrapped with stressed silicon-carbide monofilament and protected by a rigid, titanium-steel shell. Each of these artificial "bones" has attachment points for the myomer "muscles" and servos that drive the BattleMech. This skeletal construction helps make BattleMechs less vulnerable and easier to repair than vehicles supported by stressed-skin shells.

#### Muscles

Two different systems are used to drive BattleMechs and control their movements. Small, electrically driven actuators move a 'Mech's light weapons and sensor arrays. Bundles of polyacetylene fibers called myomers control a 'Mech's limbs and main weapons. Myomers contract when exposed to electrical current, much like human muscles. And if a BattleMech's myomers are damaged in battle, technicians can replace the fiber bundles with new ones or "transplant" myomers from other parts of the 'Mech's skeleton. Transplanted myomer bundles cannot restore full function to a damaged limb, but they do provide limited mobility and strength.

#### Armor and Weapons

Two separate layers of armor provide modern BattleMechs with protection against energy and projectile weapons. Usually, aligned-crystal steel is used for an outer layer of armor. The aligned-crystal steel has excellent heat-conducting properties, and so it provides excellent protection against lasers and particle-beam weapons. An inner layer of boron nitride impregnated with diamond monofilament stops high-explosive armor-piercing (HEAP) rounds and fast neutrons. This second layer of armor also prevents any armor fragments from damaging the BattleMech's internal systems.

BattleMechs usually carry charged-particle-beam weapons or lasers as their primary armaments, because energy weapons can be powered virtually indefinitely by a 'Mech's onboard fusion reactor and do not require ammunition reloads. In addition to energy weapons, many BattleMechs carry launching racks for short- or long-range non-nuclear missiles. Still other 'Mechs mount rapid-fire autocannons or machine guns for use against infantry, aircraft and other BattleMechs.

#### Power

BattleMechs require a large, constant power supply for movement and combat. The fusion reactor, which produces enormous amounts of electricity from ordinary water, is the most efficient system for providing this power. And because the fusion reaction created by a BattleMech's power plant does not release neutrons, the power plant can operate indefinitely without becoming radioactive.

The fusion plant produces electricity by a process known as magnetohydrodynamics. In this process, magnetic fields are used to channel plasma from the fusion reaction into a loop. This plasma is electrically conductive, and so the loop functions as a powerful generating coil, producing both electricity and waste heat. Every BattleMech carries radiators called heat sinks to help dissipate this waste heat. Heat sinks are especially important, because excessively high internal temperatures can disrupt the magnetic containment fields around a BattleMech's reactor. And if a power plant's magnetic "jar" is disrupted, an uncontrolled fusion reaction may occur, releasing neutrons and exposing the BattleMech's internal systems and its pilot to damaging and lethal radiation.

#### Movement

BattleMechs can attain walking or running speeds ranging from 40 to 100 kilometers per hour in open terrain. Dense forests, swamps, and steep slopes will slow a 'Mech, but very few terrain features can stop one. In addition, many 'Mechs can jump over obstacles by superheating air with their fusion reactors and jetting it out through so-called jump jets. Jump-capable BattleMechs operating on worlds without atmospheres often carry small quantities of mercury to use as reaction mass for their jets. And all BattleMechs can move underwater when crossing rivers or small lakes.

Spaceborne BattleMechs can make assault landings from low orbit. Special reaction jets housed in their feet allow them to soft-land from altitudes of up to 320 kilometers. During re-entry, breakaway ablative shields protect a BattleMech's vulnerable sensors and weapons.

# TECHNICAL READOUT

## Weapons and Heat-Dissipation Strategies

Because a BattleMech's systems are pushed to their limits during combat, 'Mechs engaged in combat generate large amounts of waste heat rapidly. We've already discussed how excessive internal temperatures can disrupt a fusion reactor's magnetic containment shields. But excessive heat can also impair or permanently damage a 'Mech's electronics and computer systems, slowing the BattleMech's movement and reducing the accuracy of its weapons.

Heat sinks are one way of controlling the heat build-up in a 'Mech. But the heat pouring out of these radiators can produce strong infrared (IR) signatures, which can make a 'Mech easy to target. To solve this problem, MechWarriors have found other ways to control heat build-up. Often, MechWarriors will position their machines in shallow lakes or rivers. Through the processes of conduction and convection, the running water helps dissipate the 'Mech's internal heat, allowing a higher rate of activity. On temperate or cold worlds, the atmosphere itself can help dissipate waste heat in the same manner. On the other hand, the high outside temperatures of a desert or jungle environment can exacerbate a BattleMech's heating problems.

Perhaps the most common way MechWarriors control heat-build-up is by regulating the movement and firing rates of their machines manually or by reprogramming the machine's movement control computer and its secondary systems. These computers can be used to limit the 'Mech's rate of activity and the resulting heat build-up. For example, when a 'Mech is sent to a high-temperature world, its activity-rate setting may be lowered. The 'Mech will move more slowly and fire less often than it would on a temperate planet. When a 'Mech is sent to fight in an arctic climate, the setting is raised, allowing faster movement and a higher rate of fire. Reprogramming is usually carried out while the BattleMech force is en route to its assignment aboard DropShips. The process takes approximately two weeks.

Because BattleMechs are always adjusted for the expected external temperature of their combat environments, sudden increases in outside temperature can have a devastating impact on a 'Mech's ability to dissipate waste heat. Tacticians have developed a series of battle tactics to take advantage of this 'Mech characteristic. For example, commanders regularly set forests on fire while enemy BattleMechs are advancing through them. The superheated air roaring around the 'Mechs can overload the machine's cooling systems or drastically reduce their efficiency, thus hampering the machines' combat capabilities.

## CONCLUSION

The BattleMech has come a long way since the *Mackie*, and undoubtedly will evolve in directions we can only guess at today. Skobel is proud to have played a part in the development of these technological wonders and looks forward to playing a significant role in the continuing saga of the BattleMech.

## EQUIPMENT

This section briefly describes the main armaments and other pieces of vital equipment used by Inner Sphere and Clan forces. **BattleTech** statistics for heat produced, Damage Value, range and tonnage appear in the Weapons and Equipment Tables, pages 104–106 of the **BattleTech Compendium: The**

**Rules of Warfare**, and also in the Master Tables on pages 125–27 of **Maximum Tech**. **BattleTech** rules for using these weapons and equipment appear on pages 112–22 of the **BattleTech Compendium: The Rules of Warfare**.

The equipment is listed below in alphabetical order.

## ARROW IV MISSILE ARTILLERY SYSTEM

The Arrow IV is a stand-alone missile system designed to deliver long-range salvos as a supplement to conventional artillery pieces such as the Long Tom, Thumper and Sniper. The main advantage of the Arrow IV is its relatively light weight compared to other artillery, but its munitions are very expensive.

The Arrow system uses two basic types of missiles. More common and relatively less expensive are standard area-saturation missiles, which attack an area rather than a specific target, inflicting massive explosive damage on any object within a 45-meter blast radius. The second type, a homing missile, homes in on a target designated by a spotting unit on the battlefield that carries target acquisition gear (TAG). The homing missile causes very little collateral damage.

Clan Arrow IV systems can also fire Thunder munitions.

## ARTILLERY WEAPONS

Generally mounted in vehicles and sometimes in BattleMechs, these extremely large projectile weapons enable units to launch shells at targets several kilometers away. The most commonly used artillery weapons are the Long Tom, Sniper and Thumper, in addition to the Arrow IV missile artillery system described above.

## AUTOCANNON (AC)

An autocannon is a rapid-fire, auto-loading weapon that fires high-speed streams of high-explosive, armor-piercing shells. Light autocannons range from 30 to 90mm; heavy autocannons may be 80 to 120mm or larger. Autocannons are also available in advanced LB-X models that fire cluster munitions—acting like an anti-BattleMech shotgun—and Ultra models that can fire at double the normal rate.

## BEAGLE ACTIVE PROBE

Capable of detecting and identifying even shutdown and camouflaged units at distances much greater than standard-issue electronic warfare (EW) suites, the active probe makes a valuable addition to any recon unit.

## C<sup>3</sup> COMPUTER

Only Inner Sphere units can use the Command/Control/Communications (C<sup>3</sup>) computer system. Intended for installation in command or reconnaissance 'Mechs or vehicles, the C<sup>3</sup> system is designed to help unit commanders coordinate activities on the lance and company levels.

## EXTRA-LIGHT (XL) ENGINE

Advances in fusion power-plant shielding have allowed engineers to retro-fit standard engines with new and lighter shielding materials, greatly reducing overall engine weight, but at the cost of compactness. The Clan version of the XL engine is much less bulky than those developed so far in the Inner Sphere.

# TECHNICAL READOUT

## FLAMER

Though not especially potent weapons, flamers can be quite effective if used as intended. The horrific damage done by flamers can crush the morale of unarmored infantry units. Flamers can also damage units hidden in trenches and field-works, as well as damaging or overheating enemy 'Mechs.

## GAUSS RIFLE

The Gauss rifle uses a series of magnets to propel a projectile through the rifle barrel toward a target. Though it requires a great deal of power to operate, this weapon generates very little heat and can achieve twice the muzzle velocity of any conventional weapon. Gauss rifles are also available in a light variant that sacrifices hefty damage-dealing capability for lighter overall weight and a longer range.

## GUARDIAN ECM SUITE

The Guardian ECM suite is a broad-spectrum jamming and electronic countermeasure device designed to reduce the effectiveness of enemy long-range scanning and surveillance equipment.

## HEAT SINKS

Heat sinks are designed to protect an engine and other components from heat build-up by shedding a certain amount of engine- and weapons-generated heat. Many newer 'Mechs are equipped with advanced double heat sinks, which are bulky and expensive but can dissipate twice as much heat as standard models.

## LASER

Laser is an acronym for "Light Amplification through Stimulated Emission of Radiation." When used as a weapon, a laser damages its target by concentrating extreme heat on a small area. BattleMech lasers come in three sizes: small, medium and large.

Lasers are also available in extended-range (ER) versions that offer longer range, but at a considerably higher cost in heat. The remaining variant, the pulse laser, gives greater accuracy at the cost of higher heat and shorter ranges.

## LONG-RANGE MISSILES (LRM)

Long-range missile racks fire salvos of high-explosive missiles at distant targets. LRMs can be equipped with various special submunitions: flare, fragmentation, incendiary, semi-guided, Swarm, Swarm-I and Thunder.

## MACHINE GUN

Though rarely carried by BattleMechs, a machine gun's high rate of fire makes it an excellent anti-infantry weapon.

## MEDIUM-RANGE MISSILES (MRM)

MRMs evolved to fill the need for cheap, easily produced weapons that the hordes of inexperienced warriors flooding the ranks of the DCMS in the late 3050s could use effectively. Initially, many observers considered MRMs a giant step backward in weapons development. Originally dubbed "dead-fire missiles" or "dummy rockets," MRMs are unguided missile systems. Like machine guns and lasers, these missiles are aimed at a target "over iron sights." Though this configuration makes

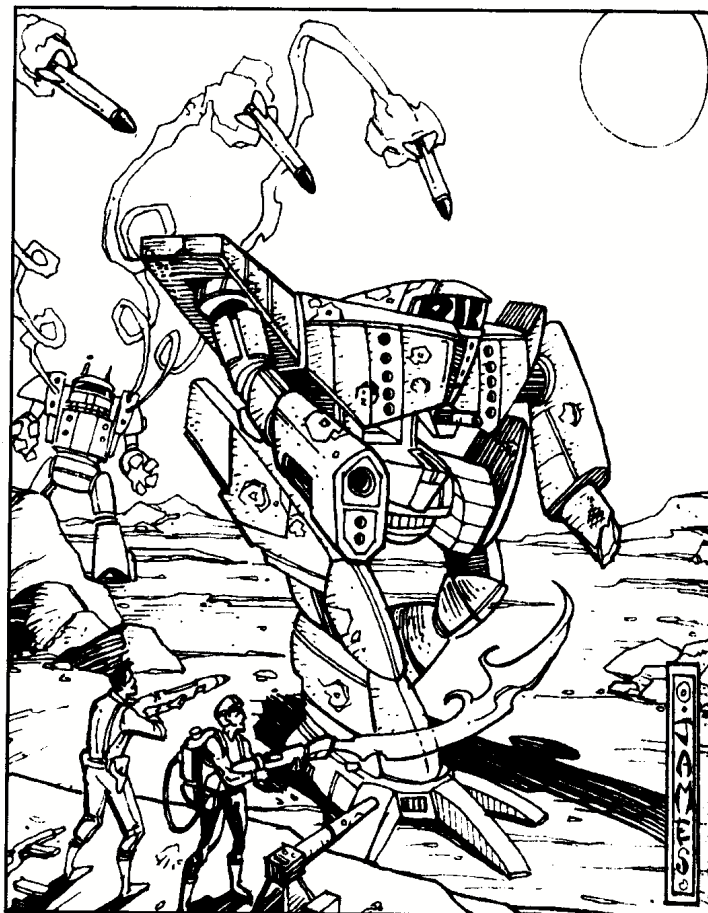

MRMs less accurate than guided missile systems, the lack of targeting systems and steering thrusters dramatically reduces the size of each missile. Consequently, a standard-sized MRM launcher holds far more missiles than a comparably sized LRM rack.

## PARTICLE PROJECTOR CANNON (PPC)

A PPC consists of a magnetic accelerator firing high-energy proton or ion bolts that cause damage through impact and high temperature. PPCs are among the most effective weapons available to BattleMechs. PPCs also come in extended-range (ER) versions, which fire at a longer range but produce considerably higher heat.

## SHORT-RANGE MISSILES (SRM)

SRMs are direct-trajectory missiles with high-explosive or armor-piercing explosive warheads. They are accurate only at ranges of less than 300 meters, but are more powerful than LRMs.

SRMs also come in Streak versions, which contain a device that prevents the missile from launching unless the missile has locked on to a target. Once locked on, the missile automatically hits.

## TARGET ACQUISITION GEAR (TAG)

A spotter uses target acquisition gear to designate a target for an attack by a homing missile fired from an Arrow IV missile artillery system.

# TECHNICAL READOUT

## INNER SPHERE BATTLEMECHS

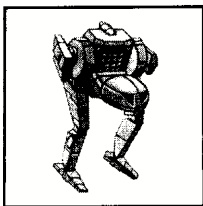

**JR7-K JENNER**  
**Mass:** 35 tons  
**Cruising Speed:** 76 kph  
**Armament:**  
SRM 4  
4 Medium Lasers

### Commentary

A light 'Mech favored by House Kurita, the *Jenner* can be found in most Draconis Combine Mustered Soldiery regiments. Impressive firepower at close range, combined with incredible speed and agility, makes the *Jenner* a perfect reconnaissance and fast-strike scout 'Mech.

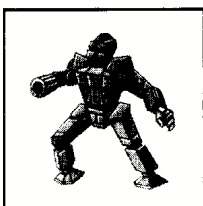

**CNS-D CENTURION**  
**Mass:** 50 tons  
**Cruising Speed:** 65 kph  
**Armament:**  
LB 10-X AC  
LRM 10  
2 Medium Lasers

### Commentary

Popular throughout the armies of the Inner Sphere, the *Centurion* is a reliable design that has seen constant combat for centuries. Thick armor, impressive firepower at multiple ranges and increased speed from the installation of an extra-light engine make the *Centurion* a feared opponent.

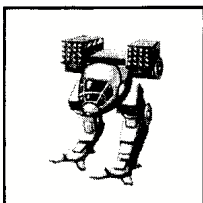

**CPLT-C3 CATAPULT**  
**Mass:** 65 tons  
**Cruising Speed:** 43 kph  
**Armament:**  
Arrow IV System  
4 Medium Lasers

### Commentary

A heavy 'Mech with a long, distinguished record, the *Catapult* is most popular with House Liao troops. Recently upgraded from long-range missile racks to the advanced Arrow IV artillery system, the new *Catapult* is proving deadly as a fire-support 'Mech.

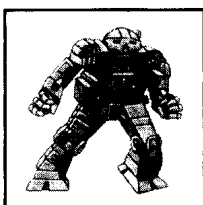

**AS7-K ATLAS**  
**Mass:** 100 tons  
**Cruising Speed:** 32 kph  
**Armament:**  
Gauss Rifle  
LRM 20  
2 ER Large Lasers  
2 Medium Pulse Lasers

### Commentary

Unveiled in the final days of the Star League, the *Atlas* was designed to be the king of the battlefield. Mounting more armor than almost any other design and packing a deadly array of weapons, the *Atlas* regularly lives up to its designers' expectations.

## CLAN OMNIMECHS

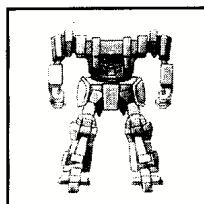

**DASHER**  
**Mass:** 20 tons  
**Cruising Speed:** 108 kph  
**Armament (Primary Configuration):**  
2 ER Medium Lasers  
SRM 6  
SRM 4  
Anti-Missile System  
Streak SRM 4

### Commentary

The *Dasher*—known as the *Fire Moth* among the Clans—is one of the fastest 'Mech designs ever produced. Its incredible bursts of speed give Clan forces a level of tactical mobility that Inner Sphere forces simply cannot match.

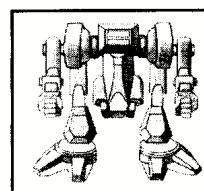

**BLACK HAWK**  
**Mass:** 50 tons  
**Cruising Speed:** 54 kph  
**Armament (Primary Configuration):**  
12 ER Medium Lasers

### Commentary

The *Black Hawk*—known as the *Nova* among the Clans—is a mainstay of most Clan militaries. The primary configuration, with its complement of twelve extended-range medium lasers, can deliver a devastating barrage of firepower that is almost unmatched by any other design.

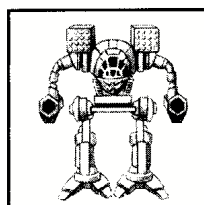

**MAD CAT**  
**Mass:** 75 tons  
**Cruising Speed:** 54 kph  
**Armament (Primary Configuration):**  
2 ER Large Lasers  
2 ER Medium Lasers  
2 LRM 20s  
1 Medium Pulse Laser  
2 Machine Guns

### Commentary

The *Mad Cat*—called the *Timber Wolf* among the Clans—is the flagship OmniMech of almost every Clan, especially Clan Wolf. Powerful, fast and well protected, many consider it the pinnacle of 'Mech designs. Very few MechWarriors walk away victorious from a fight with this ferocious OmniMech.

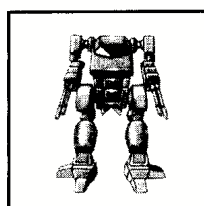

**MASAKARI**  
**Mass:** 85 tons  
**Cruising Speed:** 43 kph  
**Armament (Primary Configuration):**  
4 ER PPCs  
LRM 10

### Commentary

The *Masakari*—dubbed the *Warhawk* among the Clans—is a mobile weapons platform. The primary configuration, which

# TECHNICAL READOUT

mounts four exceptionally powerful extended-range PPCs, provides this 'Mech with enough firepower to cripple most enemy units well before they are within range to return fire.

## VEHICLES

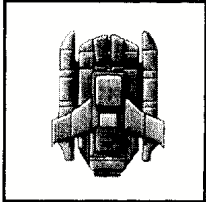

**HARASSER MISSILE PLATFORM**  
**Mass: 25 tons**  
**Cruising Speed: 108 kph**  
**Armament:**  
2 SRM 6s

### Commentary

Fast and agile, yet packing a bite, the Harasser epitomizes the light vehicle. With its ability to strike fast and hard and then fade away, the Harasser is usually used to pin down or flank enemy formations. The fact that the Harasser is a hover vehicle only enhances its usefulness.

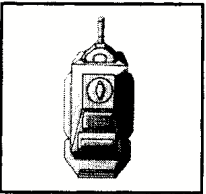

**HETZER WHEELED ASSAULT GUN**  
**Mass: 40 tons**  
**Cruising Speed: 43 kph**  
**Armament:**  
AC/20

### Commentary

An unusual design, the Hetzer lacks prestige among most militaries because of its slow speed, relatively light armor and lack of gun turrets. However, its massive Type 20 autocannon can be deadly to the unwary.

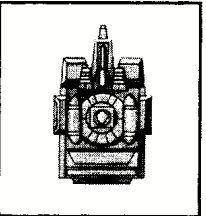

**PATTON TANK**  
**Mass: 65 tons**  
**Cruising Speed: 43 kph**  
**Armament:**  
AC/10  
LRM 5  
Small Laser  
Flamer

### Commentary

The Patton—along with its sister vehicle, the Rommel—can be found in almost every Inner Sphere vehicle unit. Patterned after the standard tank that has been in use for centuries, the Patton is a solid design that will always deliver consistent performance on the field of battle.

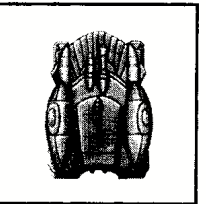

**DEMOLISHER HEAVY TANK**  
**Mass: 80 tons**  
**Cruising Speed: 32 kph**  
**Armament:**  
2 AC/20s

### Commentary

Building on the philosophy that if one is good, two must be better, the Demolisher takes the Hetzer design one step further by mounting two massive Type 20 autocannons. However, the

much heavier Demolisher mounts vastly superior armor protection for its crew than the lighter Hetzer.

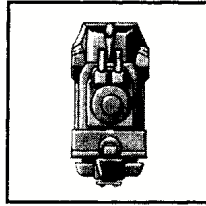

**ARMORED PERSONNEL CARRIERS**  
**Mass: 10 tons**  
**Cruising Speed: various**  
**Armament:**  
2 Machine Guns

### Commentary

Armored personnel carriers (APCs) come in hover, tracked and wheeled configurations, allowing for easy transport of infantry regardless of the terrain or weather conditions. However, these units are woefully underarmed and armored, and should never be deployed as combat vehicles.

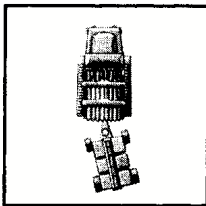

**J-27 ORDNANCE TRANSPORT**  
**Mass: 10 tons**  
**Cruising Speed: 54 kph**  
**Armament:**  
Machine Gun

### Commentary

The J-27 is one of the more popular vehicles for transporting live ordnance to the battlefield. However, its slow speed and light armor make it a deathtrap in a battle. In fact, House Kurita is known for assigning convicted criminals the job of crewing J-27s.

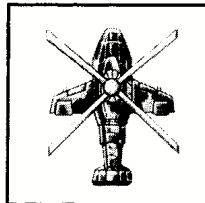

**WARRIOR HB ATTACK HELICOPTER**  
**Mass: 20 tons**  
**Cruising Speed: 108 kph**  
**Armament:**  
LRM 5  
2 Streak SRM 2s

### Commentary

The Warrior helicopter is the premier VTOL in service with the militaries of the Inner Sphere. Fast, agile, adaptable, solidly built and cheap to produce, the Warrior can be seen in reconnaissance roles on almost every Inner Sphere world.

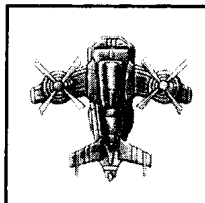

**KARNOV UR TRANSPORT**  
**Mass: 30 tons**  
**Cruising Speed: 108 kph**  
**Armament:**  
2 Machine Guns

### Commentary

With more than six tons of cargo space, the Karnov is an essential transport vehicle for any military. Its tilt-wing VTOL capability enables the Karnov to insert a full motorized infantry platoon into almost any combat situation quickly and efficiently, providing infantry with a mobility that they normally lack.

# TECHNICAL READOUT



## NEPTUNE SUBMARINE

**Mass:** 100 tons  
**Cruising Speed:** 32 kph  
**Armament:**

LRM 20  
2 SRM 6s  
Large Laser

### Commentary

Though relatively rare in the Inner Sphere, the submarine still reigns supreme in its native element. The Neptune, one of the only new designs to appear in the past several centuries, is fielded almost exclusively by Davion forces in defense of their naval assets.

## INFANTRY



### STANDARD INFANTRY

**Armament:**  
One of the following weapons: Rifle, Machine Gun, Flamer, Laser or SRM

### Commentary

Standard Inner Sphere infantry units generally lack top-notch equipment and training, but make up for those deficiencies in sheer numbers. Deployed in foot, motorized or jump configurations and armed with one of several types of weapons, infantry are best deployed as defensive troops.

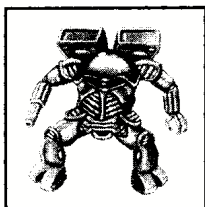

### ELEMENTAL BATTLE ARMOR

**Armament:**  
SRM 2  
One of the following weapons: Flamer, Machine Gun, Small Laser

### Commentary

Genetically bred to be super-soldiers, the huge Elemental warriors of the Clans wear armored suits built with the Clans' superior technology that automatically gives them an edge over their Inner Sphere counterparts. These giants can bring down 'Mechs by themselves if the MechWarrior is unwary.

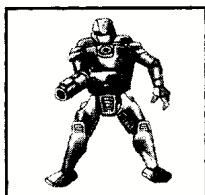

### INNER SPHERE BATTLE ARMOR

**Armament:**  
One of the following weapons: Flamer, Machine Gun, Small Laser

### Commentary

Acquired Clan technology, in conjunction with brilliant innovations by numerous military research facilities around the Inner Sphere, has allowed Inner Sphere armies to field a growing number of powered battle-armor suits for infantry troops. However, even though they provide vastly superior protection for infantry, all battle armor currently fielded by the Inner Sphere is inferior to the Clan equivalent.

## ARTILLERY

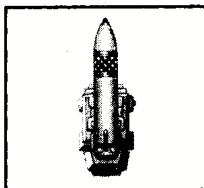

### ARTILLERY

**Armament:**  
One of the following: Arrow IV Missile System, Long Tom, Thumper, Sniper

### Commentary

Artillery assets come in numerous incarnations. From static pieces to self-contained mobile units to towed field guns, artillery is used in most Inner Sphere militaries. Though the Clans historically have not used this valuable fighting tool, the lessons they have learned from the Inner Sphere about its effectiveness have begun to change their views.

## INNER SPHERE AEROSPACE FIGHTERS

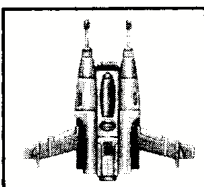

### SPR-H5 SPARROWHAWK

**Mass:** 30 tons  
**Armament:**  
2 Medium Lasers  
2 Small Lasers

### Commentary

One of the more famous light aerospace fighters in military service, the *Sparrowhawk* has made a name for itself among aerospace fighter pilots. Heavily armored for so light a craft, it can survive combat that brings down many heavier fighters.

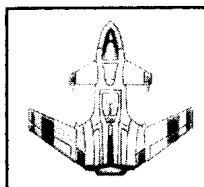

### F-90 STINGRAY

**Mass:** 60 tons  
**Armament:**  
2 Medium Lasers  
2 Large Lasers  
PPC

### Commentary

Most popular in House Marik forces, the *Stingray* is a holdover from a long-forgotten era, before aerospace fighter craft could fly in the atmosphere of a planet. That the *Stingray* is still employed by most House militaries after so many centuries is a testament to its capabilities.

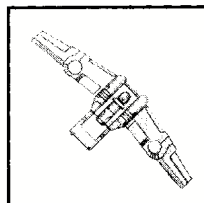

### CHP-W5 CHIPPEWA

**Mass:** 90 tons  
**Armament:**  
2 LRM 15s  
4 Large Lasers  
2 Small Lasers  
2 Medium Lasers  
SRM 6

### Commentary

Developed as a heavy fighter with long- and short-range combat capabilities, the *Chippewa* was constructed during the Star League era. The *Chippewa's* flying-wing design gives it greater surface control area than most fighters, a distinct advantage when operating in atmospheric conditions.



# TECHNICAL READOUT

## CLAN AEROSPACE FIGHTERS

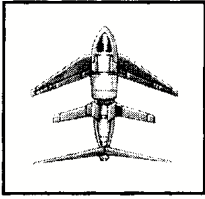

**VANDAL**  
**Mass: 30 tons**  
**Armament (Primary Configuration):**  
2 ER Small Lasers

### Commentary

Though highly maneuverable, this Clan OmniFighter is one of the least versatile aerospace craft available to Clan forces. Clan commanders therefore tend to deploy it only for high-speed strikes, when getting in and out as fast as possible is the goal.

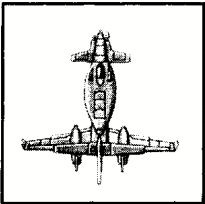

**VISIGOTH**  
**Mass: 60 tons**  
**Armament (Primary Configuration):**  
LB 10-X AC  
5 ER Medium Lasers  
2 Streak SRM 4s  
Small Pulse Laser

### Commentary

Eclipsed in popularity among the Clans only by the *Jagatai*, the *Visigoth* is an old design that has withstood the tests of time and combat. Originally fielded by Clan Jade Falcon, its versatility and speed, along with a rugged frame that can stand up to massive damage, quickly made it a favorite in every Clan.

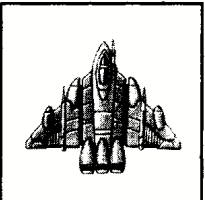

**KIRGHIZ**  
**Mass: 100 tons**  
**Armament (Primary Configuration):**  
LB 10-X AC  
2 Gauss Rifles  
2 Streak SRM 6s  
2 ER Large Lasers  
ER Small Laser

### Commentary

One of the deadliest aerospace fighters ever to see service, the *Kirghiz* is a terror in the skies. Though less maneuverable than most craft, it mounts excellent armor protection, and has a colossal 56.5 tons of pod space in which to mount weapons. This staggering array of weapons even rivals some DropShips in firepower.

## DROPSHIPS

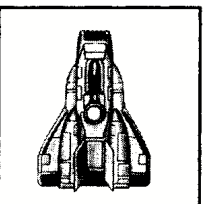

**LEOPARD (UPGRADED VERSION)**  
**Mass: 1,800 tons**  
**Armament:**  
2 ER PPCs  
3 LRM 20s  
5 ER Large Lasers  
7 Medium Pulse Lasers

### Commentary

The ideal raider, the *Leopard* class DropShip has served the Inner Sphere since the dawn of the Star League. Able to transport a lance of 'Mechs and a lance of aerospace fighters, this classic design has recently seen an upgrading of its systems in an effort to match Clan advancements.

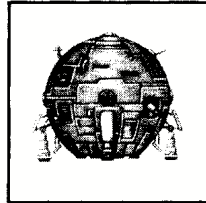

**UNION (UPGRADED VERSION)**  
**Mass: 3,500 tons**  
**Armament:**  
3 ER PPCs  
6 LRM 20s  
3 Gauss Rifles  
5 ER Large Lasers  
12 Medium Lasers

### Commentary

The *Union* is regarded as the yardstick against which all other DropShips are judged. Well-armed and armored, this spheroid craft can deliver a company of BattleMechs together with their MechWarriors, technical support crews and aerospace support into the hottest landing zone.

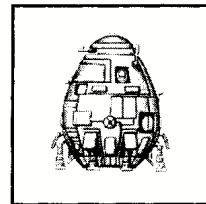

**OVERLORD (UPGRADED VERSION)**  
**Mass: 9,700 tons**  
**Armament:**  
4 ER PPCs  
6 Gauss Rifles  
3 LRM 20s  
6 ER Large Lasers  
6 Medium Lasers  
4 Medium Pulse Lasers

### Commentary

The *Overlord* is the largest 'Mech carrier in service with the Inner Sphere. The standard version carries an entire 'Mech battalion, complete with aerospace support, making it one of the sights most feared by ground forces. The Clan variant is the only DropShip that carries a larger 'Mech complement than its Inner Sphere counterpart.

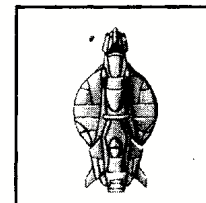

**AVENGER (UPGRADED VERSION)**  
**Mass: 1,400 tons**  
**Armament:**  
2 ER PPCs  
AC/20  
3 Gauss Rifles  
4 LRM 20s  
3 ER Large Lasers  
8 Medium Pulse Lasers

### Commentary

Well-armed and armored, the *Avenger* rivals the *Union* for firepower. The vessel's small size and considerable speed enable it to outmaneuver most opposing craft, providing *Avenger* crews with a decisive edge in almost all combat situations.

# TECHNICAL READOUT

## WARSHIPS

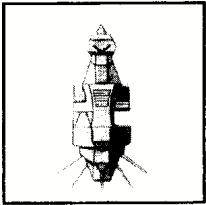

### WHIRLWIND (DESTROYER)

**Mass: 520,000 tons**

**Armament:**

- 2 ER Small Lasers
- 4 Large Lasers
- 4 Large Pulse Lasers
- 4 LRM 20s
- 6 Streak SRM 6s
- 4 Naval AC/25s
- 3 Naval AC/35s
- 12 Naval Laser 45s
- 2 Light Naval PPCs
- 3 Light Naval Gauss Cannons

### Commentary

An upgraded version of the old *Davion* class destroyer, the *Whirlwind* is a WarShip that has not seen much favor among the Clans. Though well armored for a ship of its size, its anti-aerospace fighter weapons are subpar in the view of most Clan commanders.

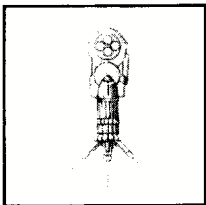

### TEXAS (BATTLESHIP)

**Mass: 1,560,000 tons**

**Armament:**

- 2 Naval AC/40s
- 48 Naval Laser 45s
- 16 Heavy Naval PPCs
- 4 Killer Whale Missile Launchers
- 8 Maelstrom AR-10 Missile Launchers

### Commentary

Constructed following the development of Valiant Lamellar ferro-carbide armor during the Star League era, this ship was built to withstand more punishment than any other vessel ever constructed. Mounting the equivalent of more than 4,500 tons of conventional armor, the *Texas* can take assaults brutal enough to destroy other vessels.

## JUMPSHIP

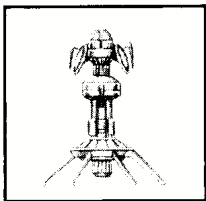

### INVADER

**Mass: 152,000 tons**

**Armament:**

- 2 PPCs or 2 Large Lasers

### Commentary

The *Invader* class JumpShip is the most common JumpShip in the Inner Sphere and the Clan occupation zones. First launched in 2631, this versatile vessel has met with surprising success and is popular with both military units and commercial users.

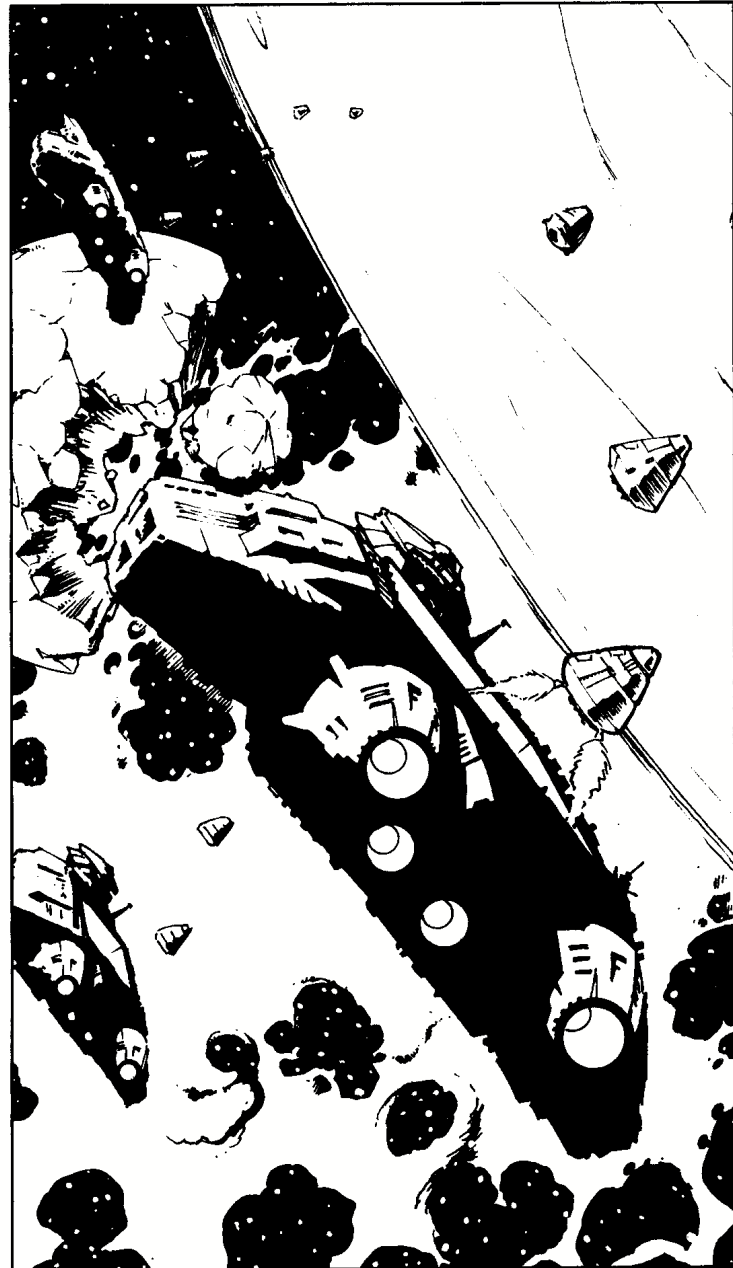

## SPACE STATION

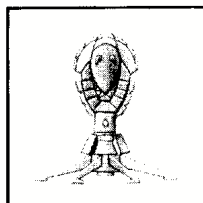

### OLYMPUS RECHARGE STATION

**Mass: 1,000,000 tons**

**Armament:**

None

### Commentary

The *Olympus* class recharge station is the largest and most common station still in service. The *Olympus* weighs a little more than one million tons and measures 1,500 meters in diameter. Each of the station's eight energy-collection banks can quick-charge a JumpShip's Kearny-Fuchida hyperdrive.

# BATTLEFORCE 2

## BATTLEFORCE ROSTER

The following roster includes all vehicles, BattleMechs, infantry, aerospace fighters and DropShips published by FASA as of December 1997. Variants of vehicles are listed in parentheses after the name of the vehicle; the Clan names of 'Mechs appear in parentheses after the 'Mech.

The point value of each unit reflects its movement, attack and defense capabilities. However, the capabilities of battlefield units are not the only factors that affect the overall effectiveness of a fighting force. Terrain, for example, can have a significant impact on effectiveness in combat. If the point totals of both sides are equal but one side outnumbers the other side, the smaller force will be at a disadvantage. Most important, the skill and experience of the controlling player is always a major factor in the effectiveness of a **BattleForce** or **Planetary Assault** force. Quantifying these factors in any meaningful way is virtually impossible, and so they are not represented in the point system.

### ROSTER KEY

**Name:** Element Name

**MP:** Movement Points

**Damage:** Damage Value

**PB:** Pointblank

**M:** Medium

**L:** Long

**Overheat:** Overheat Value

**Class:** Weight Class or Element Type

**Armor/Structure:** Armor and Structure

**Point Value:** Point Value of Unit

**Specials:** Special Equipment/Abilities

### INNER SPHERE VEHICLE TABLE

Name	MP	Damage PB/M/L	Over- heat	Class	Armor/ Structure	Point Value	Specials
AC/2 Carrier	3t	1/1/1	—	H	—/2	3	
Alacorn Mk VI Heavy Tank	3t	3/5/5	—	A	—/9	14	
APC (Hover)	10h	—/—/—	—	L	—/1	0.5	tran1
APC (Tracked)	6t	—/—/—	—	L	—/2	1	tran1
APC (Wheeled)	6w	—/—/—	—	L	—/2	1	tran1
Arrow IV Piece	1w	1/2/2	—	AR	—/1	2	artA, mof
Badger A	6t	1/1/—	—	L	—/3	2	tran4
Badger B	6t	1/1/—	—	L	—/3	2	tran4
Badger C	6t	—/1/1	—	L	—/3	2	tran4, if
Badger D	6t	2/2/—	—	L	—/3	3	tran4
Badger E	6t	3/—/—	—	L	—/3	2	tran4
Badger Tracked Transport	6t	2/2/—	—	L	—/3	3	tran4
Bandit A	9h	1/1/1	—	M	—/7	5	tran4
Bandit B	9h	1/1/—	—	M	—/7	4	tran4
Bandit C	9h	2/2/—	—	M	—/7	4	tran4
Bandit D	9h	—/1/1	—	M	—/7	5	tran4, if
Bandit E	9h	1/1/1	—	M	—/7	5	tran4, if
Bandit F	9h	1/1/—	—	M	—/7	5	tran4
Bandit G	9h	3/2/—	—	M	—/7	5	tran4
Bandit Hovercraft	9h	2/2/—	—	M	—/7	6	tran4
Beagle	12h	1/1/—	—	L	—/2	2	
Behemoth Heavy Tank	2t	6/6/1	—	A	—/9	7	if
Behemoth (Flamer Variant)	2t	4/3/1	—	A	—/9	7	if
Blizzard Hover Transport	9h	—/—/—	—	L	—/2	2	tran6
Brutus Assault Tank	3t	4/4/1	—	H	—/6	8	if
Bulldog Medium Tank	4t	2/2/—	—	H	—/4	4	
Bulldog (AC/2 Variant)	4t	2/2/—	—	H	—/4	3	
Bulldog (LRM Variant)	4t	2/2/1	—	H	—/4	5	if
Burke	2t	3/4/4	—	H	—/5	6	
Cavalry Attack Helicopter	10v	1/1/—	—	L	—/2	6	
Cavalry (SRM Variant)	10v	2/2/—	—	L	—/2	7	

# BATTLEFORCE ROSTER

Name	MP	Damage PB/M/L	Over- heat	Class	Armor/ Structure	Point Value	Specials
Centipede Scout Car	8h	1/1/—	—	L	—/2	2	prb
Challenger X MBT	3t	5/5/3	—	A	—/10	12	
Chaparral	4t	3/3/2	—	A	—/4	5	artA
Chevalier Light Tank	6w	1/1/1	—	L	—/4	4	
Condor Heavy Hover Tank	8h	2/2/1	—	M	—/4	4	
Condor (Davion Variant)	8h	1/1/1	—	M	—/4	4	
Condor (Liao Variant)	8h	2/2/—	—	M	—/5	5	
Coolant Truck 135-K	4w	—/—/—	—	L	—/4	1	cool
Cyrano	12v	1/1/—	—	L	—/1	8	prb
Demolisher Heavy Tank	3t	4/4/—	—	A	—/7	6	
Demon	4w	3/3/2	—	H	—/6	8	
Drillson Heavy Hover Tank	9h	2/2/1	—	M	—/5	7	if
Drillson (SRM Variant)	9h	2/2/—	—	M	—/5	7	
Engineering Vehicle	6t	—/—/—	—	M	—/2	0.5	eng
Ferret Light Scout VTOL	15v	—/—/—	—	L	—/1	0.5	tran1
Ferret (Armor Variant)	15v	—/—/—	—	L	—/1	1	
Ferret (Cargo Transport)	15v	—/—/—	—	L	—/1	0.5	tran2
Flatbed Truck	5w	—/—/—	—	L	—/1	0.5	tran6
Fulcrum Heavy Hovertank	10h	2/2/1	—	M	—/6	8	ecm, tag, if
Fury	4t	1/2/2	—	A	—/9	7	
Gabriel	15h	1/1/—	—	L	—/1	2	
Galleon Light Tank GAL-100	6t	1/1/—	—	L	—/2	2	
Galleon GAL-200	6t	1/1/—	—	L	—/3	2	
Galleon Light Tank	7t	2/2/—	—	L	—/4	4	prb
Gladius Medium Hover Tank	8h	1/1/—	—	M	—/4	4	
Goblin Medium Tank	4t	1/1/—	—	M	—/5	3	tran1
Goblin (LRM Variant)	4t	1/1/1	—	M	—/5	4	tran1, if
Goblin (SRM Variant)	4t	2/2/—	—	M	—/5	4	tran1
Goblin Infantry Support Vehicle	4t	2/2/—	—	M	—/7	4	tran3
Harasser Missile Platform	10h	2/2/—	—	L	—/2	3	
Harasser (Laser Variant)	10h	1/1/—	—	L	—/2	2	
Harasser (LRM Variant)	10h	—/1/1	—	L	—/2	3	if
Heavy Hover APC	8h	—/—/—	—	L	—/2	1	tran6
Heavy LRM Carrier	2t	2/5/5	—	A	—/3	8	
Heavy Tracked APC	5t	—/—/—	—	L	—/3	1	tran6
Heavy Wheeled APC	6w	—/—/—	—	L	—/3	1	tran6
Hetzer Wheeled Assault Gun	4w	2/2/—	—	M	—/4	4	
Hover APC	10h	—/—/—	—	L	—/1	0.5	tran1
Hunter Light Support Tank	5t	1/1/1	—	L	—/4	4	if
Hunter Light Support Tank (3058)	4t	1/2/2	—	L	—/3	5	if
J. Edgar Light Hover Tank	11h	1/1/—	—	L	—/4	3	
J. Edgar (Flamer Variant)	11h	1/1/—	—	L	—/4	2	
J. Edgar (Machine Gun Variant)	11h	1/1/—	—	L	—/4	3	
J-27 Ordnance Transport & Trailer	5w	—/—/—	—	L	—/1	0.5	tran11
Kanga	8h	1/2/1	—	M	—/3	7	if
Karnov UR Transport	11v	—/—/—	—	L	—/1	0.5	tran6
Karnov UR Transport (3058)	10v	—/—/—	—	L	—/1	1	tran7
Kestrel VTOL	12v	—/—/—	—	L	—/1	1	tran3
Lightning	11h	1/1/—	—	L	—/3	3	
Light SRM Carrier	4t	3/3/—	—	M	—/3	4	
Long Tom Piece	1w	1/2/2	—	AR	—/1	2	artL, mof
LRM Carrier	3t	1/3/3	—	H	—/2	7	if
LRM Carrier (3058)	2t	2/5/5	—	H	—/3	7	if, c3s
Magi	5t	2/2/—	—	H	—/7	4	
Manticore Heavy Tank	4t	2/3/2	—	H	—/7	6	
Manticore Heavy Tank (3058)	4t	3/3/1	—	H	—/7	6	if
Marksman	4t	1/1/1	—	H	—/6	4	artS

# BATTLEFORCE ROSTER

Name	MP	Damage PB/M/L	Over- heat	Class	Armor/ Structure	Point Value	Specials
MASH Truck	5w	1/—/—	—	L	—/2	1	mash
Maultier Hover APC	9h	—/—/—	—	L	—/2	1	tran3
Maxim Heavy Hover Transport	8h	2/2/1	—	M	—/4	5	if, tran3
Maxim Heavy Hover Transport (3058)	8h	2/2/1	—	M	—/4	5	tran3, tag, if
Maxim (Anti-Personnel)	8h	3/1/1	—	M	—/4	5	tran3, tag, if
Maxim (Fire Support)	8h	1/2/2	—	M	—/4	6	tran3, if
Mobile Headquarters	6w	1/1/—	—	L	—/3	3	hq
Mobile Long Tom (w/2 Ammo, 2 Support)	2t	2/1/2	—	A	—/8	5	artL
Monitor Naval Vessel	3n	3/3/—	—	H	—/6	6	tran1
Myrmidon Medium Tank	4t	2/2/1	—	M	—/5	5	
Neptune Submarine (underwater)	3s	1/1/—	—	A	—/9	6	
Neptune (LRM Variant) (underwater)	3s	—/—/—	—	A	—/9	7	
Neptune (SRM Variant) (underwater)	3s	—/—/—	—	A	—/9	7	
Nightshade	14v	1/1/—	—	L	—/2	4	ecm
Ontos Heavy Tank	3t	4/5/1	—	A	—/6	6	if
Ontos (LRM Variant)	3t	2/3/3	—	A	—/7	9	if
Ontos Heavy Tank (3058)	3t	6/7/1	—	A	—/7	8	if
Packrat LRPV PKR-T5	7w	1/1/—	—	L	—/2	2	tran1
Padilla Heavy Artillery Tank	5t	2/2/2	—	H	—/4	6	artA, tag
Partisan Heavy Tank	3t	2/2/2	—	A	—/5	8	
Partisan (AC/2 Variant)	3t	1/1/1	—	A	—/5	3	
Partisan (LRM Variant)	3t	2/3/3	—	A	—/5	8	if
Partisan Air Defense Tank	3t	2/2/2	—	A	—/7	6	c3s
Partisan (Company Command)	3t	2/2/2	—	A	—/7	6	c3m, c3m
Partisan (Lance Command)	3t	1/2/2	—	A	—/7	5	c3s
Patton Tank	4t	2/1/—	—	H	—/9	5	
Pegasus Scout Hovertank	8h	2/2/—	—	L	—/4	4	
Pegasus Scout Hovertank (3058)	9h	2/2/—	—	L	—/3	5	ecm, prb, tag
Peregrine Attack VTOL	12v	2/1/—	—	L	—/1	5	
Pike Support Vehicle	3t	1/1/1	—	H	—/6	3	
Pilum Heavy Tank	4w	3/5/2	—	H	—/7	6	if
Pinto Attack VTOL	10v	2/2/—	—	L	—/3	10	prb, tran1
Plainsman Medium Hovertank	9h	2/2/—	—	L	—/3	4	
Prowler Explorer Vehicle	4t	2/2/1	—	M	—/5	4	prb, tran4
Po Heavy Tank	4t	1/1/—	—	H	—/7	4	
Puma	3t	4/5/3	—	A	—/8	10	if
Regulator Hovertank	9h	1/2/2	—	M	—/4	10	
Rhino	3t	2/3/2	—	A	—/10	9	
Ripper	12v	1/1/—	—	L	—/1	5	tran1
Rommel Tank	4t	2/2/—	—	H	—/7	6	
Rotunda	9w	1/1/—	—	L	—/2	3	
Saladin Assault Hover Tank	8h	2/2/—	—	L	—/2	5	
Saracen Medium Hover Tank	8h	1/1/1	—	L	—/4	4	if
Savannah Master Hovercraft	13h	1/1/—	—	L	—/1	2	
Schreck PPC Carrier	3t	2/3/3	—	A	—/5	7	
Scimitar Medium Hover Tank	8h	1/1/1	—	L	—/4	3	
Scorpion Light Tank	4t	1/1/1	—	L	—/3	2	
Scorpion (SRM Variant)	4t	2/2/—	—	L	—/3	2	
Sea Skimmer Hydrofoil	12n	1/1/—	—	L	—/2	2	
Sea Skimmer (SRM 2 Variant)	12n	1/1/—	—	L	—/2	3	
Schiltron A	3w	8/4/—	—	A	—/7	10	c3m, ecm
Schiltron B	3w	4/5/5	—	A	—/7	11	c3m, ecm, if

# BATTLEFORCE ROSTER

Name	MP	Damage PB/M/L	Over- heat	Class	Armor/ Structure	Point Value	Specials
Schiltron C	3w	3/3/—	—	A	—/7	7	c3m, ecm
Schiltron	3w	4/3/4	—	A	—/7	8	c3m, ecm, artA
Skulker Wheeled Scout Tank	7w	1/1/—	—	L	—/3	2	
Sniper Piece	2w	1/1/1	—	AR	—/1	1	artS, mof
Sprint Scout Helicopter	13v	—/—/—	—	L	—/1	1	prb, tag
Sprint (C <sup>3</sup> Variant)	13v	—/—/—	—	L	—/1	1	prb, c3s
Sprint (Laser Variant)	13v	1/1/—	—	L	—/1	4	prb
Sprint (Troop Transport)	13v	—/—/—	—	L	—/1	0.5	tran2
SRM Carrier	3t	6/6/—	—	H	—/2	7	
SRM Carrier (3058)	3t	7/7/—	—	H	—/3	6	
Striker Light Tank	5w	1/1/1	—	L	—/4	3	if
Striker (LRM Variant)	5w	—/1/1	—	L	—/4	4	if
Striker Light Tank (3058)	5w	1/2/1	—	L	—/5	4	if
Striker (Narc Variant)	5w	1/2/1	—	L	—/5	4	if
SturmFeur Heavy Tank	3t	1/2/2	—	A	—/12	8	if
Swift Wind Scout Car	10w	—/—/—	—	L	—/1	0.5	
Swift Wind (ICE Variant)	10w	—/—/—	—	L	—/1	0.5	
Thor	5w	1/1/1	—	M	—/5	3	artT
Thumper Piece	1w	—/1/1	—	AR	—/1	0.5	artT, mof
Tokugawa Heavy Tank	4w	3/3/1	—	H	—/7	6	
Tracked APC	6t	—/—/—	—	L	—/2	1	tran1
Typhoon Urban Assault Vehicle	3w	5/5/—	—	H	—/8	7	prb
Vedette Medium Tank	5t	1/1/1	—	M	—/4	2	
Vedette (AC/2 Variant)	5t	1/—/—	—	M	—/4	2	
Vedette (Liao Variant)	5t	1/1/—	—	M	—/4	2	
Vedette Medium Tank (3058)	5t	1/1/1	—	M	—/5	3	
Vedette (NETC Variant)	5t	1/1/1	—	M	—/4	3	
Von Luckner							
Heavy Tank VNL-K65N	3t	4/4/—	—	H	—/7	7	
Warrior H-7 Attack Helicopter	10v	1/1/—	—	L	—/1	4	
Warrior H-7A	10v	1/1/1	—	L	—/1	4	
Warrior H-7C	10v	1/1/1	—	L	—/1	7	if
Warrior H-8 Attack Helicopter	10v	1/1/—	—	L	—/2	5	
Wheeled APC	6w	—/—/—	—	L	—/2	1	tran1
Yellow Jacket Gunship	6v	1/2/2	—	L	—/2	11	
Zephyr	9h	3/2/—	—	M	—/5	6	tag, ecm
Zhukov Heavy Tank	3t	3/3/—	—	H	—/7	5	

## INNER SPHERE BATTLEMECH TABLE

Name	MP	Damage PB/M/L	Over- heat	Class	Armor/ Structure	Point Value	Specials
Akuma AKU-1X	3	6/4/1	2	A	7/7	15	
Albatross ALB-3U	4	5/4/2	1	A	5/4	13	
Annihilator ANH-1A	2	7/5/—	1	A	5/8	12	
Annihilator ANH-2A	2	7/5/3	2	A	5/8	13	
Anvil ANV-3M	5	4/3/—	—	H	4/5	12	ecm
Apollo APL-1M	4	3/2/2	—	M	5/5	10	if
Archer ARC-2K	4	2/2/1	2	H	4/5	10	if
Archer ARC-2R	4	2/2/2	1	H	5/5	11	if
Archer ARC-2S	4	2/2/1	2	H	5/5	10	if
Archer ARC-2W	4	2/2/1	3	H	4/5	9	if
Archer ARC-4M	4	4/4/3	—	H	5/5	15	if
Archer ARC-5R	4	3/3/3	1	H	5/5	13	if
Archer ARC-5S	4	5/5/2	—	H	5/3	11	if
Archer ARC-5W	4	4/4/3	—	H	5/3	11	if
Assassin ASN-101	7	2/1/—	—	M	2/3	6	
Assassin ASN-21	7J	2/1/—	—	M	2/3	6	
Assassin ASN-23	7J	2/1/—	—	M	2/3	6	

# BATTLEFORCE ROSTER

Name	MP	Damage PB/M/L	Over- heat	Class	Armor/ Structure	Point Value	Specials
Atlas AS7-D	3	6/5/1	—	A	8/8	16	if
Atlas AS7-K	3	4/3/3	1	A	8/4	17	
Atlas AS7-S	3	6/5/1	—	A	8/8	17	
Avatar AV1-O	4	5/4/3	—	H	5/3	10	omni, if
Avatar AV1-OA	4J	4/3/1	1	H	5/3	12	omni
Avatar AV1-OB	4	3/4/4	—	H	5/3	12	omni, if
Avatar AV1-OC	4	3/3/3	—	H	5/3	11	omni, c3m
Awesome AWS-8Q	3	4/3/3	—	A	6/6	14	
Awesome AWS-8R	3	4/2/1	—	A	6/6	13	if
Awesome AWS-8T	3	4/3/1	—	A	6/6	13	if
Awesome AWS-8V	3	4/3/2	—	A	6/6	13	
Awesome AWS-9M	4	5/3/2	1	A	6/3	14	
Axman AXM-1N	4J	5/3/—	1	H	4/3	12	
Axman AXM-2N	4J	4/3/1	1	H	4/3	12	if
Bandersnatch BNDR-01A	4	6/5/3	—	H	4/3	12	
Banshee BNC-3E	4	3/2/2	—	A	6/7	12	
Banshee BNC-3M	4	3/2/1	1	A	6/7	13	
Banshee BNC-3Q	4	4/2/—	—	A	6/7	12	
Banshee BNC-3S	3	4/3/1	3	A	6/7	13	
Banshee BNC-5S	4	5/3/2	2	A	6/4	16	
Battle Hawk BH-K305	5J	3/2/—	—	L	2/1	7	
BattleMaster BLR-1D	4	5/3/1	—	A	6/7	13	
BattleMaster BLR-1G	4	4/3/1	1	A	6/7	12	
BattleMaster BLR-1S	4	4/3/1	—	A	6/7	12	if
BattleMaster BLR-3M	4	6/5/1	—	A	6/7	15	
BattleMaster BLR-3S	4	5/4/1	1	A	6/3	12	if
Berserker BRZ-A3	4	6/3/1	—	A	7/4	17	ecm
Black Hawk-KU BHKU-O	5J	6/5/—	1	H	5/2	15	omni
Black Hawk-KU BHKU-OA	5J	3/2/2	—	H	5/2	15	omni
Black Hawk-KU BHKU-OB	5J	3/2/1	—	H	5/2	12	omni
Black Hawk-KU BHKU-OC	5J	3/2/2	—	H	5/2	15	omni
Black Hawk-KU BHKU-OD	5J	3/2/2	—	H	5/2	14	omni
Black Knight BL-6-KNT	4	3/2/1	3	H	5/6	12	prb
Black Knight BL-7-KNT	4	3/2/1	3	H	4/6	11	
Black Knight BL-9-KNT	4	5/3/1	3	H	5/3	12	
Black Watch BKW-7R	3J	4/3/2	—	A	6/7	19	c3s
Blackjack BJ-1	4J	2/2/—	—	M	3/4	8	
Blackjack BJ-1DB	4J	3/2/—	1	M	3/4	9	
Blackjack BJ-1DC	4	3/2/—	—	M	3/4	7	
Blackjack BJ-2	4J	3/2/1	1	M	3/4	11	
Blackjack BJ-3	4J	3/3/1	1	M	3/4	11	
Blackjack BJ2-O	4J	5/4/2	—	M	4/2	12	omni
Blackjack BJ2-OA	4J	4/3/3	—	M	4/2	12	omni, if
Blackjack BJ2-OB	4J	3/2/2	—	M	4/2	13	omni, c3s
Blackjack BJ2-OC	4J	4/3/2	—	M	4/2	12	omni
Blackjack BJ2-OD	4J	4/3/1	2	M	4/2	13	omni
Blackjack BJ2-OE	4J	3/3/2	—	M	4/2	11	omni
Bombardier BMB-10D	4	3/2/2	1	H	5/5	10	if
Bombardier BMB-12D	5	3/2/2	—	H	5/3	13	if
Buccaneer BCN-3R	6	4/3/1	1	M	4/2	11	
Bushwacker BSW-X1	5	4/2/1	—	M	4/2	11	
Caesar CES-3R	4	5/4/3	—	H	4/3	14	
Cataphract CTF-1X	4	4/3/1	—	H	4/5	11	
Cataphract CTF-2X	4	4/3/—	—	H	5/5	10	
Cataphract CTF-3D	4J	4/3/2	—	H	4/3	13	
Cataphract CTF-3L	4	5/3/1	—	H	4/3	13	
Catapult CPLT-A1	4J	2/2/2	—	H	5/5	12	if

# BATTLEFORCE ROSTER

Name	MP	Damage PB/M/L	Over- heat	Class	Armor/ Structure	Point Value	Specials
Catapult CPLT-C1	4J	3/2/1	1	H	4/5	12	if
Catapult CPLT-C3	4J	3/2/1	1	H	4/5	10	artA
Catapult CPLT-C4	4J	2/2/2	—	H	4/5	11	if
Catapult CPLT-K2	4	4/3/2	—	H	4/5	11	
Centurion CN9-A	4	3/2/1	—	M	3/4	8	if
Centurion CN9-AH	4	3/3/1	—	M	3/4	7	if
Centurion CN9-AL	4	3/2/1	—	M	4/4	9	if
Centurion CN9-D	6	3/2/2	—	M	3/2	9	
Centurion CN9-D3	6	3/2/2	—	M	3/2	10	
Centurion CN9-YLW	4	5/3/—	—	M	3/4	8	
Cerberus MR-5M	4	6/5/2	2	A	6/4	16	
Cerberus MR-V2	4	7/6/3	—	A	5/4	18	
Cestus CTS-6Y	4	5/4/2	—	H	5/3	15	
Cestus CTS-6Z	4	4/4/2	1	H	5/3	13	
Chameleon CLN-7V	6J	2/1/—	1	M	3/4	8	
Chameleon CLN-7W	6J	3/2/1	—	M	4/4	11	
Chameleon CLN-7Z	6J	2/2/1	—	M	4/4	13	
Champion CHP-1N	5	4/3/1	—	H	4/5	9	
Champion CHP-2N	5	4/2/—	1	H	3/5	8	
Champion CHP-3N	5	4/3/1	2	H	3/2	11	
Charger CGR-1A1	5	3/—/—	—	A	4/6	8	
Charger CGR-1A5	4	4/3/—	—	A	6/6	11	
Charger CGR-1A9	4J	4/3/1	—	A	4/6	13	if
Charger CGR-1L	5	3/2/—	—	A	2/6	8	
Charger CGR-3K	5J	5/4/2	—	A	4/3	15	if
Charger CGR-SB	3	5/3/—	1	A	6/6	13	
Cicada CDA-2A	8	2/1/—	—	M	2/3	6	
Cicada CDA-2B	8	2/1/—	—	M	1/3	5	
Cicada CDA-3C	7	2/1/1	—	M	2/3	7	
Cicada CDA-3M	8	3/2/1	—	M	2/2	7	
Clint CLNT-1-2R	6	2/2/—	—	M	2/3	6	
Clint CLNT-2-3T	6J	2/2/1	—	M	2/3	7	
Clint CLNT-2-3U	6J	3/2/1	—	M	2/3	9	
Clint CLNT-2-4T	6	2/1/—	—	M	2/3	5	
Commando COM-2D	6	2/2/—	—	L	2/2	4	
Commando COM-3A	6	2/1/—	—	L	1/2	4	
Commando COM-5S	6	2/2/—	—	L	1/2	5	
Crab CRB-20	5	3/2/—	—	M	4/4	9	
Crab CRB-27	5	3/2/—	—	M	4/4	10	
Crockett CRK-5003-0	3J	3/2/—	2	A	7/7	13	
Crockett CRK-5003-1	3J	5/4/2	—	A	7/7	16	
Crusader CRD-3D	4	3/2/1	2	H	5/5	10	if
Crusader CRD-3K	4	3/3/1	—	H	5/5	10	if
Crusader CRD-3L	4J	3/2/1	1	H	5/5	10	if
Crusader CRD-3R	4	2/2/1	2	H	5/5	9	if
Crusader CRD-4D	4	3/2/1	1	H	5/5	10	if
Crusader CRD-4K	4	3/2/1	2	H	5/5	9	if
Crusader CRD-5M	4J	4/3/1	—	H	5/3	13	if
Crusader CRD-5S	4	4/3/1	1	H	5/5	11	
Cyclops CP-10-Q	4	4/3/1	—	A	7/7	12	if
Cyclops CP-10-Z	4	4/3/—	1	A	4/7	10	
Cyclops CP-11-A	4	5/4/2	—	A	4/7	13	
Cyclops CP-11-C	4	5/3/2	—	A	5/7	14	c3m
Daikyu DAI-01	5	4/3/3	—	H	5/3	13	
Daimyo DMO-1K	5	3/3/1	—	M	3/3	9	
Dart DRT-3S	9	1/—/—	—	L	1/2	4	
Dervish DV-6M	5J	2/1/1	2	M	3/5	9	if



# BATTLEFORCE ROSTER

Name	MP	Damage PB/M/L	Over- heat	Class	Armor/ Structure	Point Value	Specials
Dervish DV-7D	5J	4/3/1	—	M	4/5	13	if
Devastator DVS-2	3	7/6/4	1	A	7/4	21	
Devastator DVS-3	3	6/5/5	—	A	8/4	22	
Dragon DRG-1C	5	3/2/1	—	H	5/5	10	if
Dragon DRG-1N	5	2/2/1	—	H	4/5	10	if
Dragon DRG-5N	5	3/2/1	—	H	4/5	11	if
Dragon Fire DGR-3F	4	6/5/3	—	H	6/3	16	ecm
Emperor EMP-6A	3J	6/4/2	1	A	7/3	16	
Enfield END-6Q	5	4/3/1	—	M	4/2	11	
Enforcer ENF-4R	4J	3/2/—	—	M	4/4	9	
Enforcer ENF-5D	5J	2/1/1	1	M	4/2	10	
Excalibur EXC-B2	5	3/3/3	—	H	3/3	14	if
Excalibur EXC-C1	5	4/4/3	—	H	3/3	14	if
Exterminator EXT-4A	5J	3/2/—	1	H	4/5	11	
Exterminator EXT-4D	6J	4/3/1	—	H	4/3	12	
Falcon FLC-4N	6J	2/1/—	—	L	2/3	5	
Falcon FLC-4P	6	2/2/—	—	L	2/3	6	
Falcon Hawk FNHK-9K	5	3/2/1	—	L	3/1	9	
Falcon Hawk FNHK-9K1A	5	3/2/1	—	L	3/1	9	
Falconer FLC-8R	5J	4/3/2	2	H	5/3	19	
Fireball ALM-7D	11	1/—/—	—	L	2/1	3	
Firefly FFL-4A	5	2/1/—	1	L	2/3	6	
Firefly FFL-4B	5	2/2/—	—	L	3/3	7	
Firestarter FS9-H	6J	2/1/—	—	L	2/3	5	
Firestarter FS9-M	6J	3/1/—	—	L	3/3	7	
Firestarter FS9-O	6J	3/1/—	—	M	3/2	10	omni, prb
Firestarter FS9-OA	6J	2/1/1	—	M	3/2	9	omni
Firestarter FS9-OB	6J	4/2/—	—	M	3/2	10	omni, c3s, tag
Firestarter FS9-OC	6J	2/1/1	—	M	3/2	9	omni, c3s, if
Firestarter FS9-OD	6J	3/2/1	—	M	3/2	12	omni, c3s, ecm
Firestarter FS9-OE	6J	4/3/—	—	M	3/2	9	omni
Firestarter FS9-OF	6J	3/2/1	1	M	3/2	12	omni
Firestarter FS9-S	6J	1/1/—	—	L	2/3	6	prb
Firestarter FS9-S1	6J	1/1/—	—	L	2/3	6	ecm
Flashman FLS-7K	4	4/3/—	1	H	5/6	12	
Flashman FLS-8K	5	5/4/—	—	H	5/3	14	
Flea FLE-15	6	2/1/—	—	L	1/2	4	
Flea FLE-17	6	2/1/—	—	L	2/2	4	
Flea FLE-4	6	2/1/—	—	L	1/2	4	
Gallowglas GAL-1GLS	4	5/4/1	—	H	5/5	15	
Gallowglas GAL-2GLS	4	5/4/2	—	H	5/5	17	
Goliath GOL-1H	4	3/2/2	—	A	6/6	12	if
Goliath GOL-3M	4	3/2/2	—	A	6/3	13	if
Grand Crusader GRN-D-01	3	3/3/2	4	A	6/3	12	if
Grand Crusader GRN-D-02	3	3/4/2	2	A	6/3	12	if
Grand Dragon DRG-1G	5	2/2/1	1	H	4/5	10	
Grand Dragon DRG-5K	6	3/2/2	—	H	4/2	12	
Grand Titan T-IT-N10M	4	5/4/1	3	A	7/4	14	
Grasshopper GHR-5H	4J	4/3/—	—	H	5/5	13	
Grasshopper GHR-5J	4J	4/2/1	—	H	5/5	12	
Griffin GRF-1DS	5J	3/2/1	—	M	4/2	12	if
Griffin GRF-1N	5J	2/1/1	1	M	4/5	10	
Griffin GRF-1S	5J	3/2/—	—	M	4/5	11	
Griffin GRF-3M	5J	3/2/2	—	M	4/2	14	if
Grim Reaper GRM-R-PR29	5	3/3/2	—	M	5/2	11	if
Guillotine GLT-3N	4J	5/4/—	—	H	5/5	13	
Guillotine GLT-4L	4J	5/3/—	1	H	5/5	12	

# BATTLEFORCE ROSTER

Name	MP	Damage PB/M/L	Over- heat	Class	Armor/ Structure	Point Value	Specials
Guillotine GLT-5M	4J	4/3/1	1	H	5/5	13	
Gunslinger GUN-1ERD	3	6/5/3	—	A	6/3	22	ecm
Hammer HMR-3M	5	3/2/1	—	L	2/3	6	if
Hammer HMR-3S	5	2/1/1	—	L	2/3	5	if
Hatamoto-Chi HTM-27T	4	3/2/1	2	A	6/6	13	
Hatamoto-Hi HTM-27U	4	3/3/1	2	A	6/6	13	
Hatamoto-Kaze HTM-27V	4	3/2/2	1	A	6/6	13	
Hatamoto-Ku HTM-27W	4	3/2/2	1	A	6/6	13	
Hatamoto-Mizo HTM-27Y	4	3/2/2	1	A	6/6	13	
Hatchetman HCT-3F	4J	4/2/—	—	M	3/4	8	
Hatchetman HCT-5S	4J	3/2/1	1	M	4/2	8	
Hercules HRC-LS-9000	5	4/3/2	—	H	5/3	14	
Hermes HER-1A	9	2/1/—	—	L	1/3	5	
Hermes HER-1S	9	2/1/—	—	L	2/3	6	
Hermes HER-3S	9	2/1/—	—	L	1/3	5	prb
Hermes HER-3S1	9	2/1/—	—	L	1/3	6	ecm
Hermes HER-3S2	9	1/1/—	—	L	1/3	5	ecm, tag
Hermes II HER-2M	6	2/1/1	—	M	3/3	7	
Hermes II HER-2S	6	2/1/1	—	M	3/3	7	
Hermes II HER-5S	6	2/1/1	—	M	3/3	7	
Hermes III HER-4K	6	2/1/—	1	M	3/3	7	
Highlander HGN-732	3J	4/3/2	2	A	7/7	18	if
Highlander HGN-733	3J	4/3/1	1	A	7/7	14	if
Hitman HM-1	7	2/2/—	—	L	2/1	7	ecm, prb, tag
Hollander BZK-F3	5	2/2/2	—	L	2/3	9	
Hollander BZK-G1	5	3/2/1	—	L	3/3	8	
Hoplite HOP-4B	4	2/2/2	—	M	5/5	10	
Hoplite HOP-4C	4	2/1/—	—	M	5/5	8	
Hoplite HOP-4D	4	2/1/1	—	M	5/5	9	
Hornet HNT-151	5J	1/1/—	—	L	2/2	4	
Hornet HNT-171	5	1/1/—	—	L	2/2	5	
Hunchback HBK-4G	4	4/3/—	—	M	4/4	9	
Hunchback HBK-4H	4	4/3/—	—	M	4/4	9	
Hunchback HBK-4J	4	3/2/1	2	M	4/4	9	if
Hunchback HBK-4N	4	3/3/1	—	M	4/4	8	if
Hunchback HBK-4P	4	5/4/—	—	M	4/4	10	
Hunchback HBK-4SP	4	5/4/—	—	M	4/4	9	
Hunchback HBK-5M	4	4/3/—	—	M	4/4	9	
Hunchback HBK-5N	4	4/3/—	—	M	4/4	9	
Huron Warrior HUR-WO-R4L	5	3/2/2	1	M	4/2	11	
Huron Warrior HUR-WO-R4M	5	3/2/2	1	M	4/2	12	
Hussar HSR-200-D	9	1/1/1	—	L	1/3	6	
Hussar HSR-300-D	9	1/1/—	—	L	1/3	5	
Hussar HSR-400-D	8	2/1/1	—	L	1/1	5	
Imp IMP-2E	3	5/4/4	1	A	7/8	16	
Imp IMP-3E	3	4/3/2	3	A	7/4	14	
Jackal JA-KL-1532	7	1/1/1	—	L	2/1	7	
JagerMech JM6-A	4	2/2/1	1	H	3/5	8	if
JagerMech JM6-DD	4	4/3/2	—	H	3/3	7	
JagerMech JM6-S	4	3/2/1	—	H	2/5	7	
Javelin JVN-10F	6J	2/2/—	—	L	2/3	7	
Javelin JVN-10N	6J	2/2/—	—	L	2/3	5	
Javelin JVN-10P	6J	2/2/—	—	L	2/3	5	
Jenner JR7-D	7	3/2/—	1	L	2/3	7	
Jenner JR7-F	7	3/2/—	—	L	3/3	8	
Jenner JR7-K	7	3/2/—	1	L	2/3	7	
Katana CRK-5003-2	3J	5/3/1	1	A	5/7	13	

# BATTLEFORCE ROSTER

Name	MP	Damage PB/ML	Over- heat	Class	Armor/ Structure	Point Value	Specials
King Crab KGC-000	3	4/3/—	1	A	7/8	15	
King Crab KGC-0000	3	4/3/—	1	A	7/8	14	
King Crab KGC-001	3	4/4/3	1	A	7/4	17	
Kintaro KTO-18	5	3/2/—	2	M	4/5	9	
Kintaro KTO-19	5	3/2/—	1	M	4/5	9	
Kintaro KTO-20	5	4/3/—	1	M	4/5	11	
Komodo KIM-2	5J	5/5/—	—	M	3/2	14	ecm, tag
Komodo KIM-2A	5J	4/3/1	—	M	3/2	13	ecm, tag
Lancelot LNC25-01	6	4/3/1	—	H	4/2	12	
Lancelot LNC25-02	4	3/2/1	1	H	4/5	10	
Lineholder KW1-LH2	5	3/2/—	1	M	4/5	10	
Lineholder KW1-LH3	5	2/2/1	1	M	4/5	9	
Locust LCT-1E	8	2/1/—	—	L	2/2	5	
Locust LCT-1L	8	1/1/—	—	L	2/2	4	
Locust LCT-1M	8	1/1/1	—	L	—/2	4	if
Locust LCT-1S	8	1/1/—	—	L	1/2	4	
Locust LCT-1V	8	1/1/—	—	L	2/2	4	
Locust LCT-3D	8	1/1/1	—	L	1/2	4	if
Locust LCT-3M	8	2/1/—	—	L	1/2	5	
Locust LCT-3S	8	2/1/—	—	L	1/2	5	
Locust LCT-3V	8	2/1/—	—	L	1/2	4	
Longbow LGB-7Q	3	4/4/3	—	A	6/7	14	if
Longbow LGB-7V	3	5/5/3	—	A	6/3	14	if
Longbow LGB-OW	4	3/3/3	—	A	4/7	10	if
Lynx LNX-9C	5J	5/4/1	—	M	5/2	15	
Lynx LNX-9Q	5J	4/3/1	1	M	5/2	15	
Lynx LNX-9R	5J	4/3/1	1	M	5/2	15	
Mackie MSK-6S	3	4/3/1	—	A	5/8	12	
Maelstrom MTR-5K	5	5/3/2	—	H	6/3	15	tag
Marauder MAD-3D	4	3/2/1	2	H	5/6	11	
Marauder MAD-3L	4	3/3/1	—	H	5/6	11	
Marauder MAD-3M	4	4/3/—	—	H	5/6	11	
Marauder MAD-3R	4	3/2/2	2	H	5/6	11	
Marauder MAD-5D	4J	4/3/1	2	H	6/3	15	
Marauder MAD-5M	4J	6/4/1	—	H	5/3	14	
Marauder MAD-5S	4	5/4/3	1	H	5/3	15	
Marauder II MAD-4A	3J	5/3/2	1	A	8/8	18	
Marauder II MAD-5A	3J	5/3/2	1	A	8/4	17	
Marshal MHL-X1	4J	4/2/—	—	M	4/5	10	
Mauler MAL-1R	3	3/3/3	1	A	5/3	11	
Mercury MCY-97	8	1/1/—	—	L	1/2	4	prb
Mercury MCY-98	8	2/1/—	—	L	2/2	5	
Mercury MCY-99	8	2/1/—	—	L	1/2	5	
Merlin MLN-1A	4J	3/2/1	—	H	4/5	10	
Merlin MLN-1B	4J	3/2/1	—	H	4/5	11	
Mongoose MON-66	8	2/2/—	—	L	2/2	6	prb
Mongoose MON-67	8	2/2/—	—	L	2/2	6	
Naginata NG-C3A	3	5/5/5	—	A	6/7	17	c3m, if
Nexus NXS1-A	7	3/2/—	—	L	1/2	6	
Night Hawk NTK-2Q	6	3/2/1	—	L	3/1	9	
Nightsky NGS-4S	6J	5/2/—	—	M	4/2	10	
Nightstar NSR-9FC	4	6/5/3	—	A	7/4	16	
Nightstar NSR-9J	3	7/5/4	—	A	7/4	21	
No-Dachi NDA-1K	5	4/2/1	2	H	5/3	12	
O-Bakemono OBK-M10	4	4/2/3	1	A	6/3	10	artA
Orion ON1-K	4	3/2/1	2	H	6/6	11	if
Orion ON1-M	4	5/4/3	—	H	6/3	12	if

# BATTLEFORCE ROSTER

Name	MP	Damage PB/M/L	Over- heat	Class	Armor/ Structure	Point Value	Specials
Orion ON1-V	4	3/2/1	—	H	5/6	9	if
Orion ON1-VA	4	5/3/—	—	H	6/6	11	
Ostroc OSR-2C	5	3/2/—	1	H	4/5	10	
Ostroc OSR-2D	5	4/3/2	—	H	4/5	9	
Ostroc OSR-2L	5	3/2/—	1	H	4/5	10	
Ostroc OSR-2M	5J	3/1/—	1	H	4/5	10	
Ostroc OSR-3C	5	2/2/—	—	H	4/5	10	
Ostscout OTT-7J	8J	1/1/—	—	L	2/3	5	
Ostscout OTT-7K	8J	1/—/—	—	L	2/3	4	tag
Ostsol OTL-4D	5	3/2/—	1	H	4/5	10	
Ostsol OTL-4F	5	2/2/2	—	H	4/5	10	
Ostsol OTL-5M	5	5/3/—	—	H	4/2	11	
Owens OW-1	8	2/1/1	—	L	3/1	7	omni, tag, c3s, prb, if
Owens OW-1A	8	2/1/—	—	L	3/1	6	omni, tag, c3s, prb
Owens OW-1B	8	3/1/—	—	L	3/1	6	omni, tag, c3s, prb
Owens OW-1C	8	3/2/—	—	L	3/1	7	omni, tag, c3s, prb
Owens OW-1D	8	2/1/—	—	L	3/1	5	omni, tag, c3s, prb
Panther PNT-9R	4J	2/2/1	—	L	3/3	7	
Panther PNT-10K	4J	2/1/1	1	L	3/3	7	
Penetrator PTR-4D	4J	4/3/1	3	H	5/6	14	
Perseus P1	4	5/4/2	3	H	6/3	13	omni, if
Perseus P1A	4	5/6/3	—	H	6/3	14	omni, if, ecm, tag
Perseus P1B	4	5/4/2	—	H	6/3	14	omni
Perseus P1C	4	6/5/2	—	H	6/3	15	omni
Phoenix Hawk PXH-1	6J	2/1/—	1	M	3/4	8	
Phoenix Hawk PXH-1D	6J	2/1/—	1	M	3/4	9	
Phoenix Hawk PXH-1K	6	3/2/—	—	M	4/4	9	
Phoenix Hawk PXH-3D	6J	3/2/1	1	M	3/2	12	
Phoenix Hawk PXH-3K	6J	3/2/1	1	M	4/2	12	
Phoenix Hawk PXH-3M	6J	2/2/1	1	M	3/2	11	
Phoenix Hawk PXH-3S	6J	3/2/—	—	M	4/2	10	
Pillager PLG-3Z	3J	7/6/3	—	A	8/4	26	
Quickdraw QKD-4G	5J	3/2/1	—	H	3/5	10	if
Quickdraw QKD-4H	5J	3/2/—	1	H	3/5	10	
Quickdraw QKD-5A	5J	4/3/—	—	H	3/5	11	
Quickdraw QKD-5K	5J	3/2/1	—	H	4/5	12	if
Quickdraw QKD-5M	5J	3/2/1	—	H	4/5	11	if
Raijin RJN101-A	6J	3/2/1	2	M	3/2	11	
Rakshasa MDG-1A	5	4/4/2	1	H	5/3	14	if
Raptor RTX1-O	7	3/2/1	—	L	1/1	7	omni, if
Raptor RTX1-OA	7	3/2/—	—	L	1/1	7	omni
Raptor RTX1-OB	7	3/2/—	—	L	1/1	5	omni
Raptor RTX1-OC	7	4/3/—	—	L	1/1	8	omni
Raptor RTX1-OD	7	3/1/—	—	L	1/1	4	omni, c3s, prb, tag
Raptor RTX1-OE	7	3/1/—	—	L	1/1	5	omni
Raven RVN-3L	6	3/2/—	—	L	2/1	6	prb, tag, ecm
Rifleman RFL-3C	4	4/3/—	—	H	3/5	9	
Rifleman RFL-3N	4	2/2/—	2	H	3/5	8	
Rifleman RFL-4D	4	2/2/1	2	H	3/5	9	
Rifleman RFL-5D	4	4/3/1	2	H	4/2	11	
Rifleman RFL-5M	4	5/4/1	—	H	3/2	10	
Salamander PPR-5S	4	4/4/3	1	A	6/3	14	if
Scarabus SCB-9A	10	3/1/—	—	L	2/1	7	ecm, tag
Scorpion SCP-10	6	2/1/1	1	M	3/5	8	
Scorpion SCP-1N	6	2/2/1	—	M	3/5	8	
Sentinel STN-3K	6	2/1/1	—	M	2/3	5	
Sentinel STN-3L	6	2/1/1	—	M	2/3	6	

# BATTLEFORCE ROSTER

Name	MP	Damage PB/M/L	Over- heat	Class	Armor/ Structure	Point Value	Specials
Sentinel STN-3M	6	2/1/1	—	M	2/3	7	
Shadow Hawk SHD-2D	5	3/2/1	—	M	2/5	8	
Shadow Hawk SHD-2D2	5	3/3/1	—	M	3/5	9	
Shadow Hawk SHD-2H	5	2/2/1	—	M	4/5	9	
Shadow Hawk SHD-2K	5	2/1/1	—	M	4/5	10	
Shadow Hawk SHD-5M	5J	3/3/2	—	M	4/2	13	if
Shogun SHG-2E	3J	3/2/1	2	A	6/7	15	
Shogun SHG-2F	3J	3/2/1	2	A	6/7	15	if
Shootist ST-8A	4	6/4/1	—	H	5/5	13	
Snake SNK-1V	5J	3/2/1	—	M	3/2	9	
Spartan SPT-N2	5	5/3/1	1	A	6/3	13	tag
Spartan SPT-NF	5	5/3/1	1	A	6/3	13	
Spector SPR-5F	7J	3/2/—	—	L	3/1	11	ecm
Spider SDR-5D	8J	1/1/—	—	L	1/3	4	
Spider SDR-5K	8	1/1/—	—	L	1/3	4	
Spider SDR-5V	8J	2/1/—	—	L	1/3	5	
Spider SDR-7M	8J	2/1/—	—	L	1/3	5	
Stalker STK-3F	3	4/3/1	3	A	5/7	12	if
Stalker STK-3H	3	4/4/1	1	A	5/7	12	if
Stalker STK-4N	3	5/4/—	2	A	5/7	12	
Stalker STK-5M	3	7/6/2	—	A	6/7	13	if
Stalker STK-5S	3	3/3/—	4	A	5/3	10	
Starslayer STY-3C	5J	4/3/—	—	M	4/5	13	
Starslayer STY-3D	5J	3/2/1	1	M	4/5	14	
Stealth STH-1D	7J	3/2/—	—	M	4/2	11	prb
Stinger STG-3G	6J	1/1/—	—	L	2/2	4	
Stinger STG-3R	6J	1/1/—	—	L	1/2	3	
Stinger STG-5M	6J	1/2/—	—	L	1/2	4	
Strider SR1-O	6	3/2/—	—	M	3/3	7	omni, prb
Strider SR1-OA	6	1/—/—	—	M	3/3	6	omni, c3s, tag, prb
Strider SR1-OB	6	1/1/1	—	M	3/3	8	omni, if
Strider SR1-OC	6	2/1/—	—	M	3/3	8	omni, c3s
Strider SR1-OD	6	3/2/—	—	M	3/3	7	omni, c3s, tag
Strider SR1-OE	6	4/3/—	—	M	3/3	9	omni
Striker STC-2C	4	4/3/1	—	A	5/6	12	
Striker STC-2D	4	4/3/1	1	A	6/6	13	
Sunder SD1-O	4	7/5/—	1	A	7/3	14	omni
Sunder SD1-OA	4	6/5/3	—	A	7/3	17	omni
Sunder SD1-OB	4	5/4/2	—	A	7/3	14	omni, c3m, c3m
Sunder SD1-OC	4	8/5/—	—	A	7/3	15	omni, c3s
Talon TLN-5W	8	3/2/1	—	L	3/1	10	
Tarantula ZPH-1A	8J	2/1/—	—	L	2/1	6	
Tempest TMP-3M	4J	5/4/1	1	H	5/3	16	
Thorn THE-N	6	2/1/—	—	L	2/2	5	
Thorn THE-S	6	2/1/—	—	L	2/2	4	
Thug THG-10E	4	3/3/2	—	A	6/6	12	
Thug THG-11E	4	5/4/2	—	A	6/6	15	
Thunder THR-1L	5	6/4/—	—	H	5/3	12	
Thunder Hawk TDK-7KMA	3	3/3/3	3	A	8/4	16	artA
Thunder Hawk TDK-7X	3	6/5/3	2	A	8/4	20	
Thunder Hawk TKD-7Y	3	7/6/5	—	A	8/4	20	
Thunderbolt TDR-5S	4	3/2/1	1	H	5/5	10	if
Thunderbolt TDR-5SE	4J	3/2/—	1	H	5/5	12	
Thunderbolt TDR-5SS	4	4/3/1	—	H	5/5	11	
Thunderbolt TDR-7M	4	5/4/2	—	H	5/5	13	if
Thunderbolt TDR-9S	4	5/3/1	—	H	5/5	13	
Thunderbolt TDR-9SE	4J	4/3/1	—	H	5/5	14	if

# BATTLEFORCE ROSTER

Name	MP	Damage PB/M/L	Over- heat	Class	Armor/ Structure	Point Value	Specials
Toyama TYM-1A	4	4/4/3	1	H	5/3	14	ecm
Trebuchet TBT-5J	5J	3/2/1	—	H	3/4	10	if
Trebuchet TBT-5N	5	2/2/1	1	M	3/4	9	if
Trebuchet TBT-5S	5	4/3/—	—	M	3/4	8	
Trebuchet TBT-7K	5	2/2/2	—	M	3/4	8	
Trebuchet TBT-7M	5J	3/3/2	—	M	3/2	12	if
UrbanMech UM-R60	2J	2/1/—	—	L	2/3	5	
UrbanMech UM-R60L	2J	2/2/—	—	L	2/2	4	
UrbanMech UM-R63	2J	2/1/1	—	L	2/3	5	
Valkyrie VLK-QA	5J	1/1/1	—	L	2/3	6	if
Valkyrie VLK-QD	5J	2/1/1	—	L	3/3	7	if
Valkyrie VLK-QF	5J	1/1/1	—	L	2/3	6	if
Venom SDR-9K	8J	2/2/—	1	L	2/1	6	
Victor VTR-9A	4J	4/2/—	2	A	3/6	10	
Victor VTR-9A1	4J	5/3/—	1	A	4/6	11	
Victor VTR-9B	4J	5/3/—	1	A	5/6	12	
Victor VTR-9K	4J	5/3/2	—	A	5/6	16	
Victor VTR-9S	4J	5/3/—	1	A	4/6	11	
Vindicator VND-1AA	5J	2/2/1	—	M	2/4	8	
Vindicator VND-1R	4J	3/2/1	—	M	4/4	9	
Vindicator VND-3L	4J	2/2/1	—	M	4/4	11	
Vulcan VL-2T	6J	2/1/—	—	M	2/3	5	
Vulcan VL-5T	6J	2/1/—	1	M	3/3	7	
Vulcan VT-5M	6J	3/2/—	—	M	2/3	8	
Vulcan VT-5S	6J	2/1/1	—	M	2/2	7	
War Dog WR-DG-02FC	4	5/4/2	—	H	5/3	15	ecm
Warhammer WHM-6D	4	3/2/2	1	H	5/5	12	
Warhammer WHM-6K	4	3/3/1	1	H	4/5	10	
Warhammer WHM-6L	4	3/2/1	2	H	4/5	9	
Warhammer WHM-6R	4	3/2/1	2	H	4/5	10	
Warhammer WHM-7M	4	5/4/2	—	H	4/5	13	
Warhammer WHM-7S	4	5/4/2	—	H	4/5	12	
Wasp WSP-1A	6J	1/1/—	—	L	1/2	3	
Wasp WSP-1D	6J	2/1/—	—	L	1/2	3	
Wasp WSP-1K	6J	1/1/—	—	L	1/2	3	
Wasp WSP-1L	6J	1/1/—	—	L	1/2	3	
Wasp WSP-1S	6J	2/1/—	—	L	1/2	3	
Wasp WSP-1W	6J	2/—/—	—	L	1/2	3	
Wasp WSP-3M	6J	1/1/—	—	L	1/2	3	
Wasp WSP-3W	6J	2/—/—	—	L	1/2	3	
Watchman WTC-4M	5J	2/1/—	1	M	3/3	9	
Whitworth WTH-1	4J	2/2/1	1	M	3/3	8	if
Whitworth WTH-1S	4J	3/3/—	—	M	3/3	8	
Whitworth WTH-2	4J	2/2/1	—	M	3/3	8	if
Wolf Trap WFT-1	6	3/3/2	—	M	3/2	8	
Wolfhound WLF-1	6	2/2/—	—	L	3/3	7	
Wolfhound WLF-2	6	3/2/1	—	L	3/3	9	
Wolverine WVR-6K	5	3/2/—	1	M	5/5	10	
Wolverine WVR-6M	5J	3/2/—	—	M	4/5	11	
Wolverine WVR-6R	5J	3/2/1	—	M	4/5	10	
Wolverine WVR-7D	5J	3/2/1	—	M	4/2	11	
Wolverine WVR-7K	5J	5/3/—	—	M	5/2	12	
Wolverine WVR-7M	5J	3/3/1	1	M	4/2	13	
Wraith TR1	7J	3/2/—	—	M	4/2	11	
Wyvern WVE-5N	4J	2/1/—	1	M	4/4	9	
Wyvern WVE-6N	4J	2/1/—	1	M	3/4	8	
Wyvern WVE-9N	4J	3/3/1	—	M	3/4	10	if

# BATTLEFORCE ROSTER

Name	MP	Damage PB/M/L	Over- heat	Class	Armor/ Structure	Point Value	Specials
Zeus ZEU-6S	4	4/2/1	—	A	5/6	11	if
Zeus ZEU-6T	4	3/2/1	1	A	5/6	12	
Zeus ZEU-9S	4	4/3/2	—	A	5/6	14	

## CLAN BATTLEMECH TABLE

Name	MP	Damage PB/M/L	Over- heat	Class	Armor/ Structure	Point Value	Specials
Baboon (Howler)	7	1/1/1	—	L	1/2	6	if
Battle Cobra A	6	3/3/2	—	M	3/3	12	omni
Battle Cobra B	6	5/4/—	1	M	3/3	14	omni
Battle Cobra Prime	6	3/2/2	2	M	3/3	12	omni
Behemoth (Stone Rhino)	3J	6/5/5	1	A	7/8	26	
Black Hawk A (Nova)	5J	4/3/2	1	M	4/3	23	omni
Black Hawk B (Nova)	5J	4/2/2	—	M	4/3	15	omni
Black Hawk C (Nova)	5J	3/2/1	—	M	4/3	15	omni
Black Hawk D (Nova)	5J	3/2/2	—	M	4/3	14	omni, if
Black Hawk Prime (Nova)	5J	6/5/—	3	M	4/3	24	omni
Black Hawk S (Nova)	5J	6/5/—	—	M	4/3	21	omni, prb
Black Lanner A	7	4/3/1	—	M	4/3	18	omni, ecm, tag, prb
Black Lanner B	7	6/4/4	—	M	4/3	16	omni, if
Black Lanner C	7	5/4/—	1	M	4/3	19	omni
Black Lanner D	7	6/4/—	—	M	4/3	14	omni, prb
Black Lanner Prime	7	4/3/1	1	M	4/3	17	omni, ecm
Cauldron-Born A	5	4/4/1	4	H	5/4	19	omni
Cauldron-Born B	5	4/3/2	4	H	5/4	20	omni, tag, prb
Cauldron-Born C	5	5/4/2	—	H	5/4	17	omni
Cauldron-Born Prime	5	4/4/3	—	H	5/4	18	omni
Cougar A	5	5/4/3	—	L	3/2	14	omni, if
Cougar B	5	4/4/3	—	L	3/2	16	omni
Cougar C	5	4/4/1	1	L	3/2	14	omni
Cougar D	5	4/3/2	1	L	3/2	11	omni
Cougar Prime	5	3/3/3	—	L	3/2	12	omni
Crossbow A	5	5/4/1	—	H	5/5	16	omni, if
Crossbow B	5	6/5/—	—	H	5/5	15	omni
Crossbow Prime	5	5/3/3	—	H	5/5	17	omni, if
Daishi A (Dire Wolf)	3	9/7/5	—	A	8/6	27	omni
Daishi B (Dire Wolf)	3	6/5/3	2	A	8/6	21	omni
Daishi Prime (Dire Wolf)	3	7/6/4	3	A	8/6	23	omni
Daishi S (Dire Wolf)	3J	11/8/1	—	A	8/6	29	omni
Daishi Widowmaker (Dire Wolf)	3	8/6/4	3	A	8/6	25	omni
Dasher A (Fire Moth)	10	1/1/—	—	L	1/1	6	omni, tag, prb
Dasher B (Fire Moth)	10	2/2/—	—	L	1/1	8	omni, ecm
Dasher C (Fire Moth)	10	1/1/1	—	L	1/1/1	6	omni, if
Dasher D (Fire Moth)	10	3/3/—	1	L	1/1	14	omni
Dasher Prime (Fire Moth)	10	3/3/—	—	L	1/1	10	omni
Dragonfly A (Viper)	8J	3/3/—	2	M	3/3	18	omni
Dragonfly B (Viper)	8J	2/2/1	—	M	3/3	16	omni
Dragonfly C (Viper)	8J	3/1/—	—	M	3/3	12	omni, prb
Dragonfly D (Viper)	8J	4/3/—	—	M	3/3	17	omni
Dragonfly Prime (Viper)	8J	3/2/—	—	M	3/3	15	omni
Fenris A (Ice Ferret)	8	2/2/—	—	M	4/3	12	omni
Fenris B (Ice Ferret)	8	4/3/1	—	M	4/3	13	omni
Fenris C (Ice Ferret)	8	3/2/1	—	M	4/3	11	omni, if
Fenris D (Ice Ferret)	8	4/3/—	—	M	4/3	15	omni
Fenris Prime (Ice Ferret)	8	3/2/2	—	M	4/3	15	omni, prb
Fire Falcon A	8	2/1/1	—	L	2/2	7	omni, if
Fire Falcon B	8	2/2/2	—	L	2/2	13	omni

# BATTLEFORCE ROSTER

Name	MP	Damage PB/M/L	Over- heat	Class	Armor/ Structure	Point Value	Specials
Fire Falcon C	8	4/3/—	—	L	2/2	9	omni, prb
Fire Falcon D	8	2/2/—	—	L	2/2	7	omni, tag
Fire Falcon Prime	8	5/4/—	1	L	2/2	13	omni
Galahad (Glass Spider)	4	3/3/3	—	H	5/5	16	
Gallowglas WD	5	5/4/2	—	H	5/5	20	
Gladiator A (Executioner)	4J	6/5/3	1	A	6/5	28	omni
Gladiator B (Executioner)	4J	6/4/2	—	A	6/5	28	omni
Gladiator C (Executioner)	4J	7/5/2	—	A	6/5	25	omni, if
Gladiator D (Executioner)	4J	8/6/1	1	A	6/5	24	omni
Gladiator Prime (Executioner)	4J	5/4/4	—	A	6/5	26	omni
Goshawk (Vapor Eagle)	6J	5/4/1	1	M	4/3	22	
Grendel A	7J	4/3/2	—	M	4/3	20	omni, if
Grendel B	7J	4/3/1	—	M	4/3	18	omni
Grendel C	7J	3/2/1	—	M	4/3	15	omni
Grendel D	7J	3/2/1	2	M	4/3	20	omni
Grendel Prime	7J	4/3/1	2	M	4/3	21	omni
Griffin IIC	6J	3/2/2	1	M	3/3	15	if
Grizzly	4J	5/4/3	—	M	5/5	22	
Hankyu A	8	4/3/—	—	L	2/2	11	omni
Hankyu B	8	2/2/—	—	L	2/2	11	omni
Hankyu C	8	4/3/—	2	L	2/2	16	omni, prb
Hankyu Prime	8	3/2/1	—	L	2/2	13	omni, tag, ecm, prb
Hellhound (Conjurer)	6J	3/3/1	—	M	4/4	17	
Hunchback IIC	4J	4/4/—	2	M	2/3	15	
Jenner IIC	9	3/2/—	—	L	2/2	10	
Kingfisher A	4	7/5/3	—	A	7/7	20	omni
Kingfisher B	4	7/5/1	2	A	7/7	20	omni
Kingfisher C	4	8/6/3	—	A	7/7	24	omni
Kingfisher D	4	6/5/5	—	A	7/7	20	omni
Kingfisher Prime	4	7/6/3	—	A	7/7	21	omni
Kodiak	4	7/6/1	4	A	7/6	24	
Koshi A (Mist Lynx)	7	1/—/—	—	L	2/2	6	omni, tag, prb
Koshi B (Mist Lynx)	7	4/4/—	—	L	2/2	11	omni, prb
Koshi C (Mist Lynx)	7	2/2/1	—	L	2/2	14	omni, ecm, prb
Koshi D (Mist Lynx)	7	2/2/—	—	L	2/2	9	omni, prb
Koshi Prime (Mist Lynx)	7	2/1/1	—	L	2/2	9	omni, if, prb
Kraken	3	4/2/2	—	A	8/6	17	
Linebacker A	6	4/3/2	2	H	5/4	19	omni
Linebacker B	6	5/4/2	—	H	5/4	18	omni
Linebacker C	6	5/4/2	—	H	5/4	18	omni
Linebacker D	6	8/6/—	—	H	5/4	19	omni
Linebacker Prime	6	5/3/3	1	H	5/4	20	omni
Locust IIC	8	5/5/—	—	L	2/2	10	
Loki A (Hellbringer)	5	5/3/3	2	H	3/4	17	omni, prb
Loki B (Hellbringer)	5	5/4/2	—	H	3/4	15	omni
Loki Prime (Hellbringer)	5	5/4/2	3	H	3/4	22	omni, prb, ecm
Mad Cat A (Timber Wolf)	5	7/6/3	1	H	6/4	25	omni
Mad Cat B (Timber Wolf)	5	5/4/3	—	H	6/4	20	omni
Mad Cat C (Timber Wolf)	5	5/4/3	1	H	6/4	22	omni
Mad Cat D (Timber Wolf)	5	6/5/2	1	H	6/4	25	omni
Mad Cat Prime (Timber Wolf)	5	6/4/3	2	H	6/4	23	omni
Mad Cat Pryde (Timber Wolf)	5	5/4/3	2	H	6/4	26	omni
Mad Cat S (Timber Wolf)	5J	7/5/1	1	H	6/4	22	omni
Man O' War A (Gargoyle)	5	5/4/3	2	A	5/5	22	omni
Man O' War B (Gargoyle)	5	4/3/2	—	A	5/5	16	omni
Man O' War C (Gargoyle)	5	6/5/—	1	A	5/5	20	omni
Man O' War Prime (Gargoyle)	5	4/3/1	—	A	5/5	13	omni
Marauder IIC	4	7/6/3	2	A	6/7	22	



# BATTLEFORCE ROSTER

Name	MP	Damage PB/M/L	Over- heat	Class	Armor/ Structure	Point Value	Specials
Masakari A (Warhawk)	4	7/5/4	—	A	6/5	22	omni
Masakari B (Warhawk)	4	7/6/2	—	A	6/5	21	omni
Masakari C (Warhawk)	4	7/5/5	1	A	6/5	25	omni
Masakari Prime (Warhawk)	4	6/5/5	2	A	6/5	26	omni
Naga A	5	4/3/3	—	A	4/5	13	omni, artA
Naga B	5	4/3/3	2	A	4/5	14	omni, artA
Naga C	5	5/4/4	—	A	4/5	13	omni, artA
Naga D	5	5/3/3	1	A	4/5	13	omni, artA
Naga Prime	5	5/4/4	—	A	4/5	13	omni, artA
Night Gyr A	4J	7/5/1	.	H	6/4	25	omni
Night Gyr B	4J	4/3/3	—	H	6/4	21	omni
Night Gyr C	4J	5/4/3	1	H	6/4	24	omni
Night Gyr D	4J	5/4/4	3	H	6/4	27	omni, if
Night Gyr Prime	4J	7/6/4	1	H	6/4	28	omni
Nobori-nin A (Huntsman)	5J	4/3/3	—	M	4/3	19	omni
Nobori-nin B (Huntsman)	5J	4/3/2	1	M	4/3	20	omni
Nobori-nin C (Huntsman)	5J	4/4/2	1	M	4/3	19	omni
Nobori-nin Prime (Huntsman)	5J	4/3/1	2	M	4/3	19	omni, if, tag, prb
Peregrine (Horned Owl)	6J	3/3/1	—	L	2/3	14	
Phantom A	9	4/3/1	—	M	3/3	13	omni, if
Phantom B	9	3/2/—	—	M	3/3	10	omni, prb
Phantom C	9	6/5/—	—	M	3/3	14	omni
Phantom D	9	4/3/—	—	M	3/3	14	omni
Phantom Prime	9	2/2/—	—	M	3/3	10	omni, ecm, tag, prb
Phoenix Hawk IIC	5J	5/3/3	—	A	5/5	20	
Piranha	9	5/2/—	—	L	2/1	8	
Pouncer A	6	5/4/2	1	M	3/3	19	omni, if
Pouncer B	6	3/3/2	1	M	3/3	16	omni
Pouncer C	6	5/4/2	—	M	3/3	16	omni
Pouncer D	6	5/4/—	2	M	3/3	22	omni
Pouncer Prime	6	4/3/3	1	M	3/3	22	omni
Puma A (Adder)	6	4/3/2	—	L	3/2	13	omni, if
Puma B (Adder)	6	3/3/1	—	L	3/2	12	omni
Puma C (Adder)	6	4/3/2	—	L	3/2	13	omni, if
Puma D (Adder)	6	3/3/2	—	L	3/2	11	omni
Puma Prime (Adder)	6	3/2/2	1	L	3/2	16	omni
Rifleman IIC	3J	6/5/4	—	H	5/5	21	prb
Ryoken A (Stormcrow)	6	6/5/1	2	M	5/3	19	omni, if
Ryoken B (Stormcrow)	6	5/4/—	2	M	5/3	18	omni
Ryoken C (Stormcrow)	6	5/4/2	—	M	5/3	17	omni
Ryoken D (Stormcrow)	6	5/4/3	—	M	5/3	17	omni, if
Ryoken Prime (Stormcrow)	6	5/4/2	—	M	5/3	19	omni
Shadow Cat A	6J	4/3/2	—	M	3/3	20	omni, prb
Shadow Cat B	6J	4/4/2	—	M	3/3	21	omni, ecm, prb
Shadow Cat Prime	6J	3/3/2	—	M	3/3	21	omni, prb
Shadow Hawk IIC	6J	4/3/—	1	M	4/4	16	
Supernova	3J	6/4/4	2	A	6/7	25	
Thor A (Summoner)	5J	5/4/3	—	H	5/4	21	omni
Thor B (Summoner)	5J	6/5/3	—	H	5/4	22	omni, if
Thor C (Summoner)	5J	5/4/1	1	H	5/4	22	omni
Thor D (Summoner)	5J	6/4/2	—	H	5/4	27	omni
Thor M (Summoner)	5J	6/4/3	—	H	5/4	23	omni
Thor Prime (Summoner)	5J	5/3/3	—	H	5/4	23	omni
Thresher	5J	6/5/1	—	H	4/5	20	
Turkina A	3J	7/5/5	—	A	7/5	28	omni
Turkina B	3J	8/6/4	2	A	7/5	30	omni
Turkina C	3J	8/5/2	2	A	7/5	25	omni, prb

# BATTLEFORCE ROSTER

Name	MP	Damage PB/M/L	Over- heat	Class	Armor/ Structure	Point Value	Specials
Turkina Prime	3J	7/5/5	1	A	7/5	28	omni
Uller A (Kit Fox)	6	3/3/2	—	L	2/2	12	omni
Uller B (Kit Fox)	6	4/4/2	—	L	2/2	10	omni
Uller C (Kit Fox)	6	2/1/1	—	L	2/2	12	omni, ecm, tag, prb
Uller D (Kit Fox)	6	3/3/3	—	L	2/2	11	omni, if
Uller Prime (Kit Fox)	6	3/3/2	—	L	2/2	10	omni
Uller S (Kit Fox)	6J	4/3/1	—	L	2/2	14	omni
Viper (Black Python)	5J	5/4/2	2	H	5/4	24	
Vixen (Incubus)	9	4/3/1	—	L	3/2	14	
Vulture A (Mad Dog)	5	5/4/1	3	H	4/4	15	omni
Vulture B (Mad Dog)	5	4/4/2	3	H	4/4	19	omni
Vulture C (Mad Dog)	5	3/3/3	—	H	4/4	17	omni
Vulture Prime (Mad Dog)	5	4/4/3	2	H	4/4	19	omni
Warhammer IIC	4	7/6/2	2	A	6/6	22	
Wolfhound IIC	6	5/4/1	—	L	3/2	15	ecm

## INNER SPHERE STANDARD INFANTRY TABLE

Platoon	MP	Damage PB/M/L	Over- heat	Class	Armor/ Structure	Point Value	Specials
Foot Laser	1	1/—/—	—	I	1/—	0.25	car3
Foot MG/Flamer	1	1/—/—	—	I	1/—	0.25	car3
Foot Rifle	1	1/—/—	—	I	1/—	0.25	car3
Foot SRM	1	1/1/—	—	I	1/—	0.5	car3
Jump Laser	2J	1/—/—	—	I	1/—	0.5	car4
Jump MG/Flamer	3J	1/—/—	—	I	1/—	0.25	car4
Jump Rifle	3J	1/—/—	—	I	1/—	0.25	car4
Jump SRM	2J	1/1/—	—	I	1/—	0.5	car4
Motor Laser	2	1/—/—	—	I	1/—	0.5	car6
Motor MG/Flamer	3	1/—/—	—	I	1/—	0.25	car6
Motor Rifle	3	1/—/—	—	I	1/—	0.25	car6
Motor SRM	2	1/1/—	—	I	1/—	0.5	car6

## INNER SPHERE BATTLE ARMOR TABLE

Squad	MP	Damage PB/M/L	Over- heat	Class	Armor/ Structure	Point Value	Specials
Standard							
Flamer	3J	1/—/—	—	I	2/—	2	car4
Machine Gun	3J	1/—/—	—	I	2/—	1	car4
Small Laser	3J	1/—/—	—	I	2/—	2	car4
Kage							
Flamer	4J	—/—/—	—	I	2/—	1	car4
Machine Gun	4J	—/—/—	—	I	2/—	1	car4
Small Laser	4J	—/—/—	—	I	2/—	1	car4
TAG	4J	—/—/—	—	I	2/—	1	car4, tag
Kanazuchi	1	4/2/—	—	I	3/—	3	car4
Longinus							
Flamer	3J	2/1/—	—	I	2/—	2	car4
Machine Gun	3J	2/1/—	—	I	2/—	2	car4
Small Laser	3J	2/1/—	—	I	2/—	2	car4
Achileus							
Flamer	3J	1/—/—	—	I	3/—	1	car4
Machine Gun	3J	1/—/—	—	I	3/—	1	car4
Small Laser	3J	1/—/—	—	I	3/—	1	car4
Gray Death Light Scout Armor							
Rifle/Flamer	4J	—/—/—	—	I	1/—	1	car4, prb
Machine Gun	4J	—/—/—	—	I	1/—	1	car4, prb
Small Laser/SRM	4J	—/—/—	—	I	1/—	1	car4, prb
Infiltrator	2	—/—/—	—	I	2/—	1	car4
Sloth	3	2/—/—	—	I	1/—	1	car4

# BATTLEFORCE ROSTER

## CLAN BATTLE ARMOR TABLE

Name	MP	Damage PB/M/L	Over- heat	Class	Armor/ Structure	Point Value	Specials
Elemental							
Flamer	3J	2/1/—	—	I	3/—	2	car5
Machine Gun	3J	2/1/—	—	I	3/—	2	car5
Small Laser	3J	2/1/—	—	I	3/—	3	car5

## INNER SPHERE CONVENTIONAL FIGHTER TABLE

Name	MP	Damage PB/M/L	Over- heat	Class	Armor/ Structure	Point Value	Specials
Boeing Jump Bomber	9	—/—/—	—	L	—/1	1	
Boomerang Spotter Plane	13	—/—/—	—	L	—/1	0.5	
Guardian Fighter	7	1/—/—	—	L	—/1	1	
'MechBuster	5	2/—/—	—	M	—/1	3	
Planetlifter Air Transport	4	—/—/—	—	M	—/1	1	tran20

## INNER SPHERE AEROSPACE FIGHTER TABLE

Name	MP	Damage PB/M/L	Over- heat	Class	Armor/ Structure	Point Value	Specials
Ahab AHB-X	5	3/2/1	1	H	6/—	13	
Ahab AHB-443	5	4/3/2	2	H	6/—	12	
Centurion	10	3/—/—	—	L	3/—	5	
Cheetah F-10	12	3/—/—	—	L	1/—	3	
Cheetah F-11-R	12	1/—/—	—	L	1/—	2	
Cheetah F-11-RR	12	3/—/—	—	L	1/—	4	
Cheetah F-12-S	12	1/—/—	—	L	1/—	3	
Cheetah F-14-S	12	1/—/—	—	L	2/—	4	
Chippewa CHP-W5	5	4/3/1	3	H	3/—	11	
Chippewa CHP-W7	5	7/5/2	1	H	3/—	12	
Chippewa CHP-W10	5	5/3/2	1	H	7/—	13	
Corsair CSR-V12	6	4/2/—	—	M	5/—	8	
Corsair CSR-V12M	6	3/1/—	—	M	6/—	8	
Corsair CSR-V20	6	4/2/—	—	M	5/—	8	
Eagle	6	3/3/—	—	H	6/—	10	
Gotha GTHA-500	5	4/2/1	1	M	6/—	10	
Hammerhead HMR-HD	7	2/—/—	—	H	5/—	8	
Hellcat HCT-213	6	3/2/1	1	M	4/—	9	
Hellcat II HCT-213B	7	2/2/—	—	M	5/—	8	prb
Ironsides IRN-SD1	6	3/1/—	1	M	4/—	10	
Lightning	6	3/1/—	—	M	4/—	8	
Lucifer II LCF-16K	6	5/2/1	1	M	3/—	8	
Lucifer II LCF-16KR	6	6/3/3	—	M	3/—	11	
Lucifer LCF-R15	5	4/2/1	1	M	4/—	9	
Lucifer LCF-R16	5	6/3/3	—	M	5/—	11	
Lucifer LCF-R20	5	4/2/—	—	M	9/—	11	
Rapier RPR-100	6	4/3/1	—	H	5/—	11	
Riever F-100	5	7/1/1	—	H	6/—	12	
Riever F-100A	5	8/—/—	—	H	6/—	12	
Riever F-100B	5	5/3/1	—	H	6/—	10	
Riever F-700	6	5/3/1	—	H	6/—	13	
Riever F-700A	5	7/1/—	—	H	7/—	15	
Rogue RGU-133E	7	3/2/2	—	L	2/—	7	
Rogue RGU-133F	7	3/—/—	2	L	2/—	6	
Rogue RGU-133L	7	3/2/—	—	L	2/—	6	
Sabre	11	3/—/—	—	L	2/—	4	
Samurai SL-25	7	4/—/—	—	M	4/—	7	
Seydlitz SYD Z1	11	1/1/—	—	L	1/—	3	
Seydlitz SYD Z2	11	3/—/—	—	L	1/—	5	
Seydlitz SYD Z2A	11	3/—/—	—	L	2/—	6	

# BATTLEFORCE ROSTER

Name	MP	Damage PB/M/L	Over- heat	Class	Armor/ Structure	Point Value	Specials
Seydlitz SYD Z3	11	1/—/—	—	L	2/—	4	
Seydlitz SYD Z3A	11	1/—/—	—	L	2/—	4	
Seydlitz SYD Z4	11	1/1/1	—	L	2/—	4	
Shilone SL-17	6	4/2/1	—	M	5/—	10	
Shilone SL-17AC	6	3/1/1	—	M	5/—	8	
Shilone SL-17R	6	4/2/1	—	M	5/—	10	
Sholagar SL-21	10	3/—/—	—	L	2/—	5	
Sholagar SL-21L	10	3/—/—	—	L	2/—	5	
Slayer SL-15	6	4/1/—	—	H	6/—	10	
Slayer SL-15A	6	4/1/1	—	H	6/—	10	
Slayer SL-15B	6	3/1/1	—	H	6/—	11	
Slayer SL-15C	6	4/—/—	—	H	6/—	10	
Slayer SL-15R	6	4/1/—	—	H	6/—	11	
Spad SPD-502	7	2/1/—	—	L	3/—	5	
Sparrowhawk SPR-6D	10	3/—/—	—	L	4/—	5	
Sparrowhawk SPR-8H	10	1/—/—	—	L	3/—	4	
Sparrowhawk SPR-H5	10	3/—/—	—	L	3/—	5	
Sparrowhawk SPR-H5K	10	3/—/—	—	L	3/—	4	
Stingray F-90	6	2/2/—	1	M	5/—	9	
Stingray F-90S	6	3/3/—	—	M	4/—	8	
Stingray F-92	6	3/3/3	—	M	5/—	11	
Stingray F-94	6	2/2/2	1	M	5/—	9	
Stuka STU-D6	5	6/5/2	1	H	6/—	16	
Stuka STU-K5	5	5/4/1	1	H	6/—	13	
Stuka STU-K10	5	5/4/1	1	H	6/—	13	
Stuka STU-K15	5	5/3/1	2	H	5/—	12	
Swift SW-606	13	1/—/—	—	L	1/—	2	
Thrush TR-7	12	3/—/—	—	L	1/—	4	
Thunderbird	5	4/3/1	2	H	6/—	13	
Tomahawk THK-53	8	4/—/—	—	L	5/—	8	
Tomahawk THK-63	8	3/2/—	—	L	4/—	8	
Transgressor AC TR-14	6	5/—/—	—	H	5/—	9	
Transgressor TR-13	6	3/3/—	—	H	6/—	10	
Transgressor TR-13A	6	3/3/3	—	H	6/—	12	
Transit TR-10	6	4/—/—	1	M	4/—	8	
Transit TR-11	6	2/—/—	—	M	4/—	7	
Trident TRN-3T	12	3/—/—	—	L	1/—	4	
Zero ZRO-114	6	2/2/1	—	L	4/—	6	

## CLAN AEROSPACE FIGHTER TABLE

Name	MP	Damage PB/M/L	Over- heat	Class	Armor/ Structure	Point Value	Specials
Avar A	10	3/3/2	1	L	3/—	15	omni
Avar B	10	3/3/2	1	L	3/—	13	omni
Avar C	10	4/3/—	—	L	3/—	11	omni
Avar PRIME	10	4/4/1	1	L	3/—	14	omni
Bashkir A	13	2/1/—	—	L	2/—	5	omni
Bashkir B	13	3/2/2	—	L	2/—	5	omni
Bashkir C	13	2/1/1	—	L	2/—	7	omni
Bashkir PRIME	13	3/3/—	—	L	2/—	8	omni
Batu A	9	3/2/2	—	L	4/—	12	omni
Batu B	9	6/6/—	1	L	4/—	16	omni
Batu C	9	6/4/1	—	L	4/—	15	omni
Batu PRIME	9	6/6/2	—	L	4/—	16	omni
Jagatai A	6	7/7/2	—	M	5/—	19	omni
Jagatai B	6	5/5/5	—	M	5/—	20	omni
Jagatai C	6	4/4/4	1	M	5/—	19	omni

# BATTLEFORCE ROSTER

Name	MP	Damage PB/M/L	Over- heat	Class	Armor/ Structure	Point Value	Specials
Jagatai PRIME	6	5/5/5	2	M	5/—	21	omni
Jengiz A	5	6/6/6	1	H	7/—	23	omni
Jengiz B	5	7/7/7	2	H	7/—	24	omni
Jengiz C	5	6/6/—	—	H	7/—	16	omni
Jengiz PRIME	5	7/5/3	2	H	7/—	20	omni
Kirghiz A	5	5/5/5	2	H	7/—	24	omni
Kirghiz B	5	9/8/8	—	H	7/—	27	omni
Kirghiz C	5	6/6/4	3	H	7/—	22	omni
Kirghiz PRIME	5	7/7/7	—	H	7/—	22	omni
Sabutai A	6	6/4/—	1	H	5/—	16	omni
Sabutai B	6	6/6/6	1	H	5/—	19	omni, ecm, tag
Sabutai C	6	7/7/5	—	H	5/—	23	omni
Sabutai PRIME	6	7/6/6	1	H	5/—	22	omni
Scytha A	6	8/5/5	—	H	7/—	21	omni
Scytha B	6	7/7/7	1	H	7/—	24	omni
Scytha C	6	7/7/6	—	H	7/—	26	omni
Scytha PRIME	6	7/6/4	2	H	7/—	23	omni
Sulla A	9	4/4/3	—	L	4/—	14	omni
Sulla B	9	4/4/4	—	L	4/—	13	omni
Sulla C	9	3/3/2	—	L	4/—	16	omni
Sulla PRIME	9	3/3/3	1	L	4/—	15	omni
Turk A	7	5/3/3	—	M	4/—	14	omni
Turk B	7	5/5/—	—	M	4/—	13	omni
Turk C	7	4/4/2	1	M	4/—	16	omni
Turk PRIME	7	4/4/4	2	M	5/—	17	omni
Vandal A	14	3/1/—	—	L	2/—	6	omni
Vandal B	14	3/—/—	—	L	2/—	6	omni
Vandal C	14	2/2/—	—	L	2/—	9	omni
Vandal PRIME	14	1/—/—	—	L	2/—	4	omni, prb
Visigoth A	7	7/7/6	—	M	5/—	20	omni
Visigoth B	7	4/4/4	—	M	5/—	17	omni
Visigoth C	7	5/5/3	1	M	5/—	17	omni
Visigoth PRIME	7	5/5/—	—	M	5/—	16	omni

## INNER SPHERE DROPSHIP TABLE

Name	MP	Damage PB/M/L	Over- heat	Class	Armor/ Structure	Point Value	Specials
Achilles (Obsolete Version)	8	10/7/3	—	A	17/16	136	if
Achilles (Upgraded Version)	8	13/9/9	—	A	17/16	154	
Avenger (Obsolete Version)	7	6/4/1	—	A	14/13	60	if
Avenger (Upgraded Version)	7	6/5/5	—	A	14/13	70	
Behemoth (Right Side)	2	4/2/—	—	L	4/3	665	sph
(Left Side)		4/2/—					
Buccaneer	3	1/—/—	—	M	4/4	35	
Claymore	6	7/5/2	—	A	14/13	57	if
Condor (Obsolete Version)	3	6/4/—	—	M	9/9	56	
Condor (Upgraded Version)	3	6/4/3	—	M	9/9	58	
Excalibur (Obsolete Version)							
(Right Side)	3	6/4/2	—	L	12/12	147	sph, if
(Left Side)		6/4/2					
Excalibur (Upgraded Version)							
(Right Side)	3	6/4/4	—	L	12/12	148	sph, if
(Left Side)		6/4/4					
Fortress (Obsolete Version)							
(Right Side)	3	11/6/2	—	A	13/13	104	sph, if
(Left Side)		11/6/2					
Fortress (Upgraded Version)							
(Right Side)	3	17/10/9	—	A	13/13	116	sph, if
(Left Side)		17/10/9					

# BATTLEFORCE ROSTER

Name	MP	Damage PB/M/L	Over- heat	Class	Armor/ Structure	Point Value	Specials
Fury (Obsolete Version)	4	3/1/1	—	S	8/8	34	if
Fury (Upgraded Version)	4	5/2/2	—	S	8/8	36	if
Gazelle (Obsolete Version)	4	5/2/—	—	S	8/8	37	if
Gazelle (Upgraded Version)	4	6/2/2	—	S	9/8	43	if
Hamilcar	4	8/7/6	—	A	10/10	67	
Hannibal	5	11/9/7	—	M	12/12	102	
Hercules (Right Side)	3	6/3/2	—	L	9/8	77	sph, if
(Left Side)		6/3/2					
Intruder (Obsolete Version)							
(Right Side)	4	9/6/1	—	A	21/21	74	sph, if
(Left Side)		9/6/1					
Intruder (Upgraded Version)							
(Right Side)	4	13/8/7	—	A	21/21	85	sph
(Left Side)		13/8/7					
Kuan Ti	6	6/5/3	—	A	12/12	66	
Leopard (Obsolete Version)	4	5/4/1	—	S	9/8	39	if
Leopard (Upgraded Version)	4	8/6/6	—	S	9/8	44	if
Leopard CV (Obsolete Version)	4	5/4/1	—	S	9/8	39	if
Leopard CV (Upgraded Version)	4	8/6/6	—	S	9/8	44	if
Lung Wang	5	12/9/7	—	A	13/13	77	
Mammoth (Right Side)	3	2/1/—	—	L	4/4	412	sph
(Left Side)		2/1/—					
Model 97 "Octopus" (Right Side)	6	7/5/2	—	L	10/9	202	sph, if
(Left Side)		7/5/2					
Monarch	3	—/—/—	—	M	3/2	42	
Mule (Right Side)	3	3/1/—	—	L	5/5	99	sph
(Left Side)		3/1/—					
Nagumo	4	9/4/3	—	M	12/12	73	
Okinawa (Right Side)	3	9/7/6	—	M	11/10	63	sph, if
(Left Side)		9/7/6					
Overlord (Obsolete Version)							
(Right Side)	3	8/6/1	—	L	13/13	109	sph, if
(Left Side)		8/6/1					
Overlord (Upgraded Version)							
(Right Side)	3	9/7/7	—	L	14/13	116	sph
(Left Side)		9/7/7					
Rose (Right Side)	4	5/3/2	—	L	8/8	160	sph, if
(Left Side)		5/3/2					
Seeker (Obsolete Version)							
(Right Side)	5	4/3/1	—	M	8/8	56	sph, if
(Left Side)		4/3/1					
Seeker (Upgraded Version)							
(Right Side)	5	4/3/3	—	M	8/8	59	sph
(Left Side)		4/3/3					
Triumph (Obsolete Version)	3	6/4/1	—	M	9/9	67	if
Triumph (Upgraded Version)	3	7/5/4	—	M	10/9	74	
Union (Obsolete Version)							
(Right Side)	3	10/8/3	—	M	11/10	57	sph, if
(Left Side)		10/8/3					
Union (Upgraded Version)							
(Right Side)	3	10/8/8	—	M	11/10	66	sph
(Left Side)		10/8/8					
Vengeance (Obsolete Version)	4	10/6/2	—	L	11/10	127	if
Vengeance (Upgraded Version)	4	10/7/7	—	L	11/10	141	

# BATTLEFORCE ROSTER

## CLAN DROPSHIP TABLE

Name	MP	Damage PB/M/L	Over- heat	Class	Armor/ Structure	Point Value	Specials
Broadsword	5	9/9/6	—	S	11/10	70	if
Carrier	5	15/12/6	—	M	14/14	149	
Confederate (Right Side)	4	5/3/—	—	S	12/12	43	sph
(Left Side)		5/3/—					
Lion (Right Side)	4	8/7/5	—	L	16/15	148	sph
(Left Side)		8/7/5					
Miraborg (Right Side)	5	10/8/4	—	L	12/12	148	sph
(Left Side)		10/8/4					
Noruff	8	15/15/7	—	A	22/21	156	
Overlord-C (Right Side)	3	11/11/6	—	L	20/20	145	sph
(Left Side)		11/11/6					
Sassanid (Right Side)	4	9/8/4	—	M	12/11	70	sph, if
(Left Side)		9/8/4					
Titan	5	14/8/2	—	L	17/17	190	if
Union-C (Right Side)	4	7/7/5	—	M	15/14	83	sph
(Left Side)		7/7/5					

TECH

# PLANETARY ASSAULT REFERENCE MAP

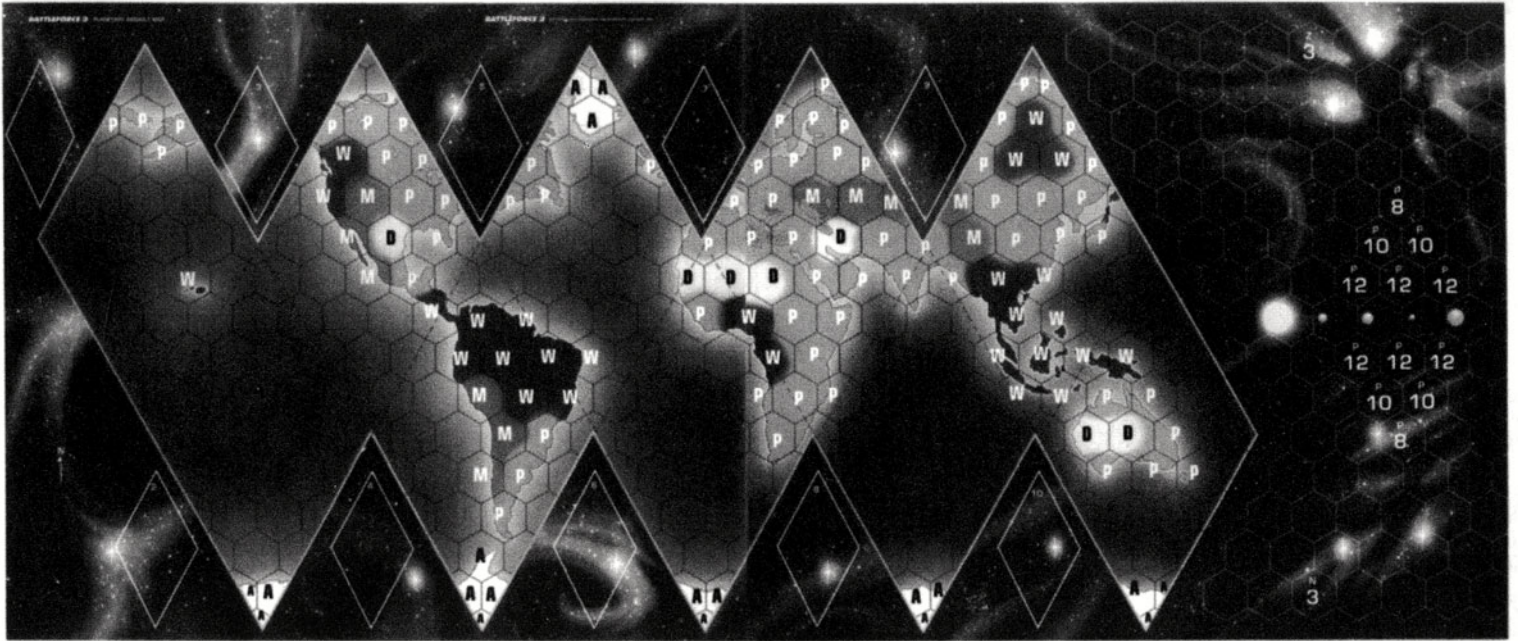

- KEY**  
P - PLAINS  
W - WOODS  
M - MOUNTAINS  
D - DESERT  
A - ARCTIC

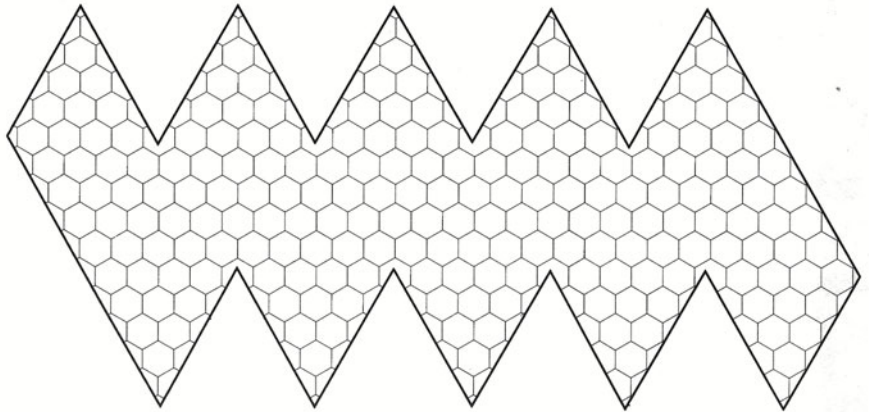
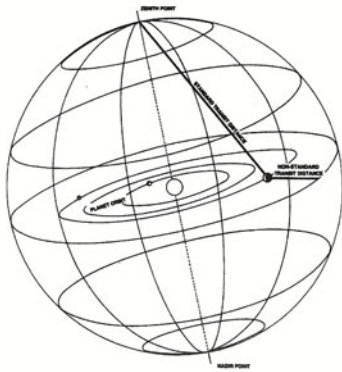

РУССА



# BATTLEFORCE® 2

## INNER SPHERE RECORD SHEET

ID: \_\_\_\_\_ Name: \_\_\_\_\_ Cmd: \_\_\_\_\_

Element	MP	PB	M	L	Wt./	Skill	Armor
OV	+0	+2	+4				
<input type="checkbox"/>	1	2	3	S			○○○○○○○○○○
<input type="checkbox"/>	1	2	3	S			○○○○○○○○○○
<input type="checkbox"/>	1	2	3	S			○○○○○○○○○○
<input type="checkbox"/>	1	2	3	S			○○○○○○○○○○

ID: \_\_\_\_\_ Name: \_\_\_\_\_ Cmd: \_\_\_\_\_

Element	MP	PB	M	L	Wt./	Skill	Armor
OV	+0	+2	+4				
<input type="checkbox"/>	1	2	3	S			○○○○○○○○○○
<input type="checkbox"/>	1	2	3	S			○○○○○○○○○○
<input type="checkbox"/>	1	2	3	S			○○○○○○○○○○
<input type="checkbox"/>	1	2	3	S			○○○○○○○○○○

ID: \_\_\_\_\_ Name: \_\_\_\_\_ Cmd: \_\_\_\_\_

Element	MP	PB	M	L	Wt./	Skill	Armor
OV	+0	+2	+4				
<input type="checkbox"/>	1	2	3	S			○○○○○○○○○○
<input type="checkbox"/>	1	2	3	S			○○○○○○○○○○
<input type="checkbox"/>	1	2	3	S			○○○○○○○○○○
<input type="checkbox"/>	1	2	3	S			○○○○○○○○○○

ID: \_\_\_\_\_ Name: \_\_\_\_\_ Cmd: \_\_\_\_\_

Element	MP	PB	M	L	Wt./	Skill	Armor
OV	+0	+2	+4				
<input type="checkbox"/>	1	2	3	S			○○○○○○○○○○
<input type="checkbox"/>	1	2	3	S			○○○○○○○○○○
<input type="checkbox"/>	1	2	3	S			○○○○○○○○○○
<input type="checkbox"/>	1	2	3	S			○○○○○○○○○○

ID: \_\_\_\_\_ Name: \_\_\_\_\_ Cmd: \_\_\_\_\_

Element	MP	PB	M	L	Wt./	Skill	Armor
OV	+0	+2	+4				
<input type="checkbox"/>	1	2	3	S			○○○○○○○○○○
<input type="checkbox"/>	1	2	3	S			○○○○○○○○○○
<input type="checkbox"/>	1	2	3	S			○○○○○○○○○○
<input type="checkbox"/>	1	2	3	S			○○○○○○○○○○

ID: \_\_\_\_\_ Name: \_\_\_\_\_ Cmd: \_\_\_\_\_

Element	MP	PB	M	L	Wt./	Skill	Armor
OV	+0	+2	+4				
<input type="checkbox"/>	1	2	3	S			○○○○○○○○○○
<input type="checkbox"/>	1	2	3	S			○○○○○○○○○○
<input type="checkbox"/>	1	2	3	S			○○○○○○○○○○
<input type="checkbox"/>	1	2	3	S			○○○○○○○○○○

ID: \_\_\_\_\_ Name: \_\_\_\_\_ Cmd: \_\_\_\_\_

Element	MP	PB	M	L	Wt./	Skill	Armor
OV	+0	+2	+4				
<input type="checkbox"/>	1	2	3	S			○○○○○○○○○○
<input type="checkbox"/>	1	2	3	S			○○○○○○○○○○
<input type="checkbox"/>	1	2	3	S			○○○○○○○○○○
<input type="checkbox"/>	1	2	3	S			○○○○○○○○○○

ID: \_\_\_\_\_ Name: \_\_\_\_\_ Cmd: \_\_\_\_\_

Element	MP	PB	M	L	Wt./	Skill	Armor
OV	+0	+2	+4				
<input type="checkbox"/>	1	2	3	S			○○○○○○○○○○
<input type="checkbox"/>	1	2	3	S			○○○○○○○○○○
<input type="checkbox"/>	1	2	3	S			○○○○○○○○○○
<input type="checkbox"/>	1	2	3	S			○○○○○○○○○○

ID: \_\_\_\_\_ Name: \_\_\_\_\_ Cmd: \_\_\_\_\_

Element	MP	PB	M	L	Wt./	Skill	Armor
OV	+0	+2	+4				
<input type="checkbox"/>	1	2	3	S			○○○○○○○○○○
<input type="checkbox"/>	1	2	3	S			○○○○○○○○○○
<input type="checkbox"/>	1	2	3	S			○○○○○○○○○○
<input type="checkbox"/>	1	2	3	S			○○○○○○○○○○

ID: \_\_\_\_\_ Name: \_\_\_\_\_ Cmd: \_\_\_\_\_

Element	MP	PB	M	L	Wt./	Skill	Armor
OV	+0	+2	+4				
<input type="checkbox"/>	1	2	3	S			○○○○○○○○○○
<input type="checkbox"/>	1	2	3	S			○○○○○○○○○○
<input type="checkbox"/>	1	2	3	S			○○○○○○○○○○
<input type="checkbox"/>	1	2	3	S			○○○○○○○○○○

# BATTLEFORCE<sup>®</sup> 2

# COMSTAR RECORD SHEET

ID: \_\_\_\_\_ Name: \_\_\_\_\_ Cmd: \_\_\_\_\_

Element	MP	PB	M	L	Wt./	Armor
	OV	+0	+2	+4	Skill	
<input type="checkbox"/>	1	2	3	S		<input type="checkbox"/>
<input type="checkbox"/>	1	2	3	S		<input type="checkbox"/>
<input type="checkbox"/>	1	2	3	S		<input type="checkbox"/>
<input type="checkbox"/>	1	2	3	S		<input type="checkbox"/>
<input type="checkbox"/>	1	2	3	S		<input type="checkbox"/>
<input type="checkbox"/>	1	2	3	S		<input type="checkbox"/>
<input type="checkbox"/>	1	2	3	S		<input type="checkbox"/>

ID: \_\_\_\_\_ Name: \_\_\_\_\_ Cmd: \_\_\_\_\_

Element	MP	PB	M	L	Wt./	Armor
	OY	+0	+2	+4	Skill	
<input type="checkbox"/>	1	2	3	S		<input type="checkbox"/>
<input type="checkbox"/>	1	2	3	S		<input type="checkbox"/>
<input type="checkbox"/>	1	2	3	S		<input type="checkbox"/>
<input type="checkbox"/>	1	2	3	S		<input type="checkbox"/>
<input type="checkbox"/>	1	2	3	S		<input type="checkbox"/>
<input type="checkbox"/>	1	2	3	S		<input type="checkbox"/>
<input type="checkbox"/>	1	2	3	S		<input type="checkbox"/>

ID: \_\_\_\_\_ Name: \_\_\_\_\_ Cmd: \_\_\_\_\_

Element	MP	PB	M	L	Wt./	Armor
	OV	+0	+2	+4	Skill	
<input type="checkbox"/>	1	2	3	S		<input type="checkbox"/>
<input type="checkbox"/>	1	2	3	S		<input type="checkbox"/>
<input type="checkbox"/>	1	2	3	S		<input type="checkbox"/>
<input type="checkbox"/>	1	2	3	S		<input type="checkbox"/>
<input type="checkbox"/>	1	2	3	S		<input type="checkbox"/>
<input type="checkbox"/>	1	2	3	S		<input type="checkbox"/>
<input type="checkbox"/>	1	2	3	S		<input type="checkbox"/>

ID: \_\_\_\_\_ Name: \_\_\_\_\_ Cmd: \_\_\_\_\_

Element	MP	PB	M	L	Wt./	Armor
	OV	+0	+2	+4	Skill	
<input type="checkbox"/>	1	2	3	S		<input type="checkbox"/>
<input type="checkbox"/>	1	2	3	S		<input type="checkbox"/>
<input type="checkbox"/>	1	2	3	S		<input type="checkbox"/>
<input type="checkbox"/>	1	2	3	S		<input type="checkbox"/>
<input type="checkbox"/>	1	2	3	S		<input type="checkbox"/>
<input type="checkbox"/>	1	2	3	S		<input type="checkbox"/>
<input type="checkbox"/>	1	2	3	S		<input type="checkbox"/>

ID: \_\_\_\_\_ Name: \_\_\_\_\_ Cmd: \_\_\_\_\_

Element	MP	PB	M	L	Wt./	Armor
	OV	+0	+2	+4	Skill	
<input type="checkbox"/>	1	2	3	S		<input type="checkbox"/>
<input type="checkbox"/>	1	2	3	S		<input type="checkbox"/>
<input type="checkbox"/>	1	2	3	S		<input type="checkbox"/>
<input type="checkbox"/>	1	2	3	S		<input type="checkbox"/>
<input type="checkbox"/>	1	2	3	S		<input type="checkbox"/>
<input type="checkbox"/>	1	2	3	S		<input type="checkbox"/>
<input type="checkbox"/>	1	2	3	S		<input type="checkbox"/>

ID: \_\_\_\_\_ Name: \_\_\_\_\_ Cmd: \_\_\_\_\_

Element	MP	PB	M	L	Wt./	Armor
	OV	+0	+2	+4	Skill	
<input type="checkbox"/>	1	2	3	S		<input type="checkbox"/>
<input type="checkbox"/>	1	2	3	S		<input type="checkbox"/>
<input type="checkbox"/>	1	2	3	S		<input type="checkbox"/>
<input type="checkbox"/>	1	2	3	S		<input type="checkbox"/>
<input type="checkbox"/>	1	2	3	S		<input type="checkbox"/>
<input type="checkbox"/>	1	2	3	S		<input type="checkbox"/>
<input type="checkbox"/>	1	2	3	S		<input type="checkbox"/>

# BATTLEFORCE<sup>®</sup> 2

## CLAN RECORD SHEET

ID: \_\_\_\_\_ Name: \_\_\_\_\_ Cmd: \_\_\_\_\_

Element	MP OV	PB +0	M +2	L +4	Wt./ Skill	Armor
<input type="checkbox"/>	1	2	3	S		○○○○○○○○○○
<input type="checkbox"/>	1	2	3	S		○○○○○○○○○○
<input type="checkbox"/>	1	2	3	S		○○○○○○○○○○
<input type="checkbox"/>	1	2	3	S		○○○○○○○○○○
<input type="checkbox"/>	1	2	3	S		○○○○○○○○○○

ID: \_\_\_\_\_ Name: \_\_\_\_\_ Cmd: \_\_\_\_\_

Element	MP OV	PB +0	M +2	L +4	Wt./ Skill	Armor
<input type="checkbox"/>	1	2	3	S		○○○○○○○○○○
<input type="checkbox"/>	1	2	3	S		○○○○○○○○○○
<input type="checkbox"/>	1	2	3	S		○○○○○○○○○○
<input type="checkbox"/>	1	2	3	S		○○○○○○○○○○
<input type="checkbox"/>	1	2	3	S		○○○○○○○○○○

ID: \_\_\_\_\_ Name: \_\_\_\_\_ Cmd: \_\_\_\_\_

Element	MP OV	PB +0	M +2	L +4	Wt./ Skill	Armor
<input type="checkbox"/>	1	2	3	S		○○○○○○○○○○
<input type="checkbox"/>	1	2	3	S		○○○○○○○○○○
<input type="checkbox"/>	1	2	3	S		○○○○○○○○○○
<input type="checkbox"/>	1	2	3	S		○○○○○○○○○○
<input type="checkbox"/>	1	2	3	S		○○○○○○○○○○

ID: \_\_\_\_\_ Name: \_\_\_\_\_ Cmd: \_\_\_\_\_

Element	MP OV	PB +0	M +2	L +4	Wt./ Skill	Armor
<input type="checkbox"/>	1	2	3	S		○○○○○○○○○○
<input type="checkbox"/>	1	2	3	S		○○○○○○○○○○
<input type="checkbox"/>	1	2	3	S		○○○○○○○○○○
<input type="checkbox"/>	1	2	3	S		○○○○○○○○○○
<input type="checkbox"/>	1	2	3	S		○○○○○○○○○○

ID: \_\_\_\_\_ Name: \_\_\_\_\_ Cmd: \_\_\_\_\_

Element	MP OV	PB +0	M +2	L +4	Wt./ Skill	Armor
<input type="checkbox"/>	1	2	3	S		○○○○○○○○○○
<input type="checkbox"/>	1	2	3	S		○○○○○○○○○○
<input type="checkbox"/>	1	2	3	S		○○○○○○○○○○
<input type="checkbox"/>	1	2	3	S		○○○○○○○○○○
<input type="checkbox"/>	1	2	3	S		○○○○○○○○○○

ID: \_\_\_\_\_ Name: \_\_\_\_\_ Cmd: \_\_\_\_\_

Element	MP OV	PB +0	M +2	L +4	Wt./ Skill	Armor
<input type="checkbox"/>	1	2	3	S		○○○○○○○○○○
<input type="checkbox"/>	1	2	3	S		○○○○○○○○○○
<input type="checkbox"/>	1	2	3	S		○○○○○○○○○○
<input type="checkbox"/>	1	2	3	S		○○○○○○○○○○
<input type="checkbox"/>	1	2	3	S		○○○○○○○○○○

ID: \_\_\_\_\_ Name: \_\_\_\_\_ Cmd: \_\_\_\_\_

Element	MP OV	PB +0	M +2	L +4	Wt./ Skill	Armor
<input type="checkbox"/>	1	2	3	S		○○○○○○○○○○
<input type="checkbox"/>	1	2	3	S		○○○○○○○○○○
<input type="checkbox"/>	1	2	3	S		○○○○○○○○○○
<input type="checkbox"/>	1	2	3	S		○○○○○○○○○○
<input type="checkbox"/>	1	2	3	S		○○○○○○○○○○

ID: \_\_\_\_\_ Name: \_\_\_\_\_ Cmd: \_\_\_\_\_

Element	MP OV	PB +0	M +2	L +4	Wt./ Skill	Armor
<input type="checkbox"/>	1	2	3	S		○○○○○○○○○○
<input type="checkbox"/>	1	2	3	S		○○○○○○○○○○
<input type="checkbox"/>	1	2	3	S		○○○○○○○○○○
<input type="checkbox"/>	1	2	3	S		○○○○○○○○○○
<input type="checkbox"/>	1	2	3	S		○○○○○○○○○○

# BATTLEFORCE® 2

## INNER SPHERE RECORD SHEET

**ID: MM1 Name: Command Lance\* Cmd: MM2, MH2, MM3, GH1, FH1**

Element	MP	PB	M	L	Wt./	Armor
	OV	+0	+2	+4	Skill	
PXH-3M Phoenix Hawk	6J	2	2	1	M/-2	○○○
<input type="checkbox"/> if	1	1	2	3	S	○○
HBK-5M Hunchback	4	4	3	—	M/-1	○○○○
<input type="checkbox"/> if	—	1	2	3	S	○○○○
GRF-3M Griffin	5J	3	2	2	M/-2	○○○○
<input type="checkbox"/> if	—	1	2	3	S	○○
CDA-3M Cicada	8	3	2	1	M/-1	○○
<input type="checkbox"/> if	—	1	2	3	S	○○

**ID: MH3 Name: Assault Lance Cmd:**

Element	MP	PB	M	L	Wt./	Armor
	OV	+0	+2	+4	Skill	
ON1-K Orion	4	3	2	1	H/-1	○○○○○○
<input type="checkbox"/> if	2	1	2	3	S	○○○○○○
MAD-5M Marauder	4J	6	4	1	H/-1	○○○○○
<input type="checkbox"/> if	—	1	2	3	S	○○○
CRD-3R Crusader	4	2	2	1	H/+0	○○○○○
<input type="checkbox"/> if	2	1	2	3	S	○○○○○
STK-3F Stalker	3	4	3	1	A/-1	○○○○○
<input type="checkbox"/> if	3	1	2	3	S	○○○○○○○

**ID: MM2 Name: Command Lance\* Cmd: MH1, MH6**

Element	MP	PB	M	L	Wt./	Armor
	OV	+0	+2	+4	Skill	
SHD-5M Shadow Hawk	5J	3	3	2	M/-1	○○○○
<input type="checkbox"/> if	—	1	2	3	S	○○
CDA-3M Cicada	8	3	2	1	M/+0	○○
<input type="checkbox"/> if	—	1	2	3	S	○○
GRF-3M Griffin	5J	3	2	2	M/-1	○○○○
<input type="checkbox"/> if	—	1	2	3	S	○○
TDR-5S Thunderbolt	4	3	2	1	H/-1	○○○○○
<input type="checkbox"/> if	—	1	2	3	S	○○○○○

**ID: MH4 Name: Support Lance Cmd:**

Element	MP	PB	M	L	Wt./	Armor
	OV	+0	+2	+4	Skill	
TBT-7M Trebuchet	5J	3	3	2	H/-2	○○○
<input type="checkbox"/> if	—	1	2	3	S	○○
WR-DG-02FC War Dog	4	5	4	2	H/-1	○○○○○
<input type="checkbox"/> ecm	—	1	2	3	S	○○○
ON1-M Orion	4	5	4	3	H/-1	○○○○○
<input type="checkbox"/> if	—	1	2	3	S	○○○
ARC-4M Archer	4	4	4	3	H/+0	○○○○○
<input type="checkbox"/> if	—	1	2	3	S	○○○○○

**ID: MH1 Name: Strike Lance Cmd:**

Element	MP	PB	M	L	Wt./	Armor
	OV	+0	+2	+4	Skill	
WHM-7M Warhammer	4	5	4	2	H/-2	○○○○○
<input type="checkbox"/> if	—	1	2	3	S	○○○○○
TMP-3M Tempest	4J	5	4	1	H/-2	○○○○○
<input type="checkbox"/> if	1	1	2	3	S	○○○
RFL-5M Rifleman	4	5	4	1	H/-1	○○○
<input type="checkbox"/> if	—	1	2	3	S	○○
MAD-5M Marauder	4J	6	4	1	H/-1	○○○○○
<input type="checkbox"/> if	—	1	2	3	S	○○○

**ID: MM3 Name: Command Lance\* Cmd: MH5, ML1**

Element	MP	PB	M	L	Wt./	Armor
	OV	+0	+2	+4	Skill	
TR1 Wraith	7J	3	2	—	M/-1	○○○○
<input type="checkbox"/> if	1	1	2	3	S	○○
WVR-7M Wolverine	5J	3	3	1	M/-1	○○○○
<input type="checkbox"/> if	—	1	2	3	S	○○
GRF-3M Griffin	5J	3	2	2	M/+0	○○○○
<input type="checkbox"/> if	—	1	2	3	S	○○
GRF-3M Griffin	5J	3	2	2	M/-1	○○○○
<input type="checkbox"/> if	—	1	2	3	S	○○

**ID: MH6 Name: Support Lance Cmd:**

Element	MP	PB	M	L	Wt./	Armor
	OV	+0	+2	+4	Skill	
WHM-7M Warhammer	4	5	4	2	H/-2	○○○○○
<input type="checkbox"/> if	—	1	2	3	S	○○○○○
OTL-5M Ostsol	5	5	3	—	H/-1	○○○○
<input type="checkbox"/> if	—	1	2	3	S	○○
ON1-M Orion	4	5	4	3	H/-1	○○○○○
<input type="checkbox"/> if	—	1	2	3	S	○○○
CP-II-A Cyclops	4	5	4	2	A/+0	○○○○○
<input type="checkbox"/> if	—	1	2	3	S	○○○○○○○

**ID: MM4 Name: Force Lance Cmd:**

Element	MP	PB	M	L	Wt./	Armor
	OV	+0	+2	+4	Skill	
HMR-3M Hammer	5	3	2	1	L/-1	○○
<input type="checkbox"/> if	1	1	2	3	S	○○○
BJ2-OE Blackjack	4J	3	3	2	M/-1	○○○○○
<input type="checkbox"/> omni	—	1	2	3	S	○○
GRF-3M Griffin	5J	3	2	2	M/+0	○○○○○
<input type="checkbox"/> if	—	1	2	3	S	○○
CDA-3M Cicada	8	3	2	1	M/+0	○○
<input type="checkbox"/> if	—	1	2	3	S	○○

**ID: MH2 Name: Command Lance\* Cmd: MH3, MH4**

Element	MP	PB	M	L	Wt./	Armor
	OV	+0	+2	+4	Skill	
QKD-5M Quickdraw	5J	3	2	1	H/-2	○○○○○
<input type="checkbox"/> if	—	1	2	3	S	○○○○○
WHM-6R Warhammer	4	3	2	1	H/-1	○○○○○
<input type="checkbox"/> if	2	1	2	3	S	○○○○○
ARC-4M Archer	4	4	4	3	H/-1	○○○○○
<input type="checkbox"/> if	—	1	2	3	S	○○○○○
ARC-4M Archer	4	4	4	3	H/-2	○○○○○
<input type="checkbox"/> if	—	1	2	3	S	○○○○○

**ID: ML1 Name: Recon Lance Cmd:**

Element	MP	PB	M	L	Wt./	Armor
	OV	+0	+2	+4	Skill	
WSP-3M Wasp	6J	1	1	—	L/-1	○
<input type="checkbox"/> if	—	1	2	3	S	○○
ZPH-1A Tarantula	8J	2	1	—	L/+0	○
<input type="checkbox"/> if	—	1	2	3	S	○
OTT-7J Ostscout	8J	1	1	—	L/+0	○
<input type="checkbox"/> if	—	1	2	3	S	○○○
WSP-3M Wasp	6J	1	1	—	L/+0	○
<input type="checkbox"/> if	—	1	2	3	S	○○

# BATTLEFORCE<sup>®</sup> 2

## INNER SPHERE RECORD SHEET

**ID:** GH1    **Name:** Command Lance\*    **Cmd:** GA2, GL1

Element	MP	PB	M	L	Wt./	Armor
	OV	+0	+2	+4	Skill	
Schreck PPC Carrier	3T	2	3	3	A/-1	○○○○○
<input type="checkbox"/>						
Schreck PPC Carrier	3T	2	3	3	A/+0	○○○○○
<input type="checkbox"/>						
Pike Support Vehicle	3T	1	1	1	A/-1	○○○○○○○
<input type="checkbox"/>						
Pike Support Vehicle	3T	1	1	1	A/-1	○○○○○○○
<input type="checkbox"/>						

**ID:** GA1    **Name:** Command Lance\*    **Cmd:**

Element	MP	PB	M	L	Wt./	Armor
	OV	+0	+2	+4	Skill	
Ontos Heavy Tank (3058)	3T	6	7	1	A/-1	○○○○○○○
<input type="checkbox"/> if						
Ontos Heavy Tank (3058)	3T	6	7	1	A/+0	○○○○○○○
<input type="checkbox"/> if						
Demolisher Heavy Tank	3T	4	4	—	A/+0	○○○○○○○
<input type="checkbox"/>						
Demolisher Heavy Tank	3T	4	4	—	A/+0	○○○○○○○
<input type="checkbox"/>						

**ID:** GL1    **Name:** Strike Lance    **Cmd:**

Element	MP	PB	M	L	Wt./	Armor
	OV	+0	+2	+4	Skill	
Galleon Light Tank	7T	2	2	—	L/+0	○○○○○
<input type="checkbox"/> prb						
Galleon Light Tank	7T	2	2	—	L/+0	○○○○○
<input type="checkbox"/> prb						
Scimitar Medium Hovertank	8H	1	1	1	L/-1	○○○○○
<input type="checkbox"/>						
Scimitar Medium Hovertank	8H	1	1	1	L/+0	○○○○○
<input type="checkbox"/>						

**ID:** IN1    **Name:** Command Company\*    **Cmd:** IN2, IN3

Element	MP	PB	M	L	Wt./	Armor
	OV	+0	+2	+4	Skill	
Foot MG Platoon	1	1	—	—	-1	○
<input type="checkbox"/> car3						
Foot MG Platoon	1	1	—	—	-1	○
<input type="checkbox"/> car3						
Foot MG Platoon	1	1	—	—	+0	○
<input type="checkbox"/> car3						
<input type="checkbox"/>						

**ID:** IN2    **Name:** Strike Company    **Cmd:**

Element	MP	PB	M	L	Wt./	Armor
	OV	+0	+2	+4	Skill	
Motor Rifle Platoon	3	1	—	—	-1	○
<input type="checkbox"/> car3						
Motor MG Platoon	3	1	—	—	-1	○
<input type="checkbox"/> car3						
Motor MG Platoon	3	1	—	—	-1	○
<input type="checkbox"/> car3						
<input type="checkbox"/>						

**ID:** IN3    **Name:** Recon Company    **Cmd:**

Element	MP	PB	M	L	Wt./	Armor
	OV	+0	+2	+4	Skill	
Jump Rifle Platoon	3J	1	—	—	-1	○
<input type="checkbox"/> car4						
Jump MG Platoon	3J	1	—	—	-1	○
<input type="checkbox"/> car4						
Jump SRM Platoon	2J	1	1	—	-1	○
<input type="checkbox"/> car4						
<input type="checkbox"/>						

**ID:** FH1    **Name:** Alpha Air Lance\*    **Cmd:** FM1, FL1

Element	MP	PB	M	L	Wt./	Armor
	OV	+0	+2	+4	Skill	
TR-13 Transgressor	6	3	3	—	H/-2	○○○○○○○
<input type="checkbox"/>	—	1	2	3	S	
TR-13 Transgressor	6	3	3	—	H/-1	○○○○○○○
<input type="checkbox"/>	—	1	2	3	S	
<input type="checkbox"/>	—	1	2	3	S	
<input type="checkbox"/>	—	1	2	3	S	

**ID:** FM1    **Name:** Beta Air Lance    **Cmd:**

Element	MP	PB	M	L	Wt./	Armor
	OV	+0	+2	+4	Skill	
F-90 Stingray	6	2	2	—	M/-2	○○○○○
<input type="checkbox"/>	1	1	2	3	S	
F-90 Stingray	6	2	2	—	M/-1	○○○○○
<input type="checkbox"/>	—	1	2	3	S	
<input type="checkbox"/>	—	1	2	3	S	
<input type="checkbox"/>	—	1	2	3	S	

**ID:** FL1    **Name:** Gamma Air Lance    **Cmd:**

Element	MP	PB	M	L	Wt./	Armor
	OV	+0	+2	+4	Skill	
F-10 Cheetah	12	3	—	—	L/-1	○
<input type="checkbox"/>	—	1	2	3	S	
F-10 Cheetah	12	3	—	—	L/-1	○
<input type="checkbox"/>	—	1	2	3	S	
<input type="checkbox"/>	—	1	2	3	S	
<input type="checkbox"/>	—	1	2	3	S	

**ID:** \_\_\_\_\_    **Name:** \_\_\_\_\_    **Cmd:** \_\_\_\_\_

Element	MP	PB	M	L	Wt./	Armor
	OV	+0	+2	+4	Skill	
<input type="checkbox"/>	—	1	2	3	S	
<input type="checkbox"/>	—	1	2	3	S	
<input type="checkbox"/>	—	1	2	3	S	
<input type="checkbox"/>	—	1	2	3	S	

# BATTLEFORCE<sup>®</sup> 2

## CLAN RECORD SHEET

ID: MM13 Name: Alpha Star\* Cmd: MH10, MM14, MH11, IB6, FH3, MA5

Element	MP	PB	M	L	Wt./	Armor
	OV	+0	+2	+4	Skill	
Shadow Cat Prime	6J	3	3	2	M/-2	○○○
<input type="checkbox"/> omni, prb	—	1	2	3	S	○○○
Ryoken Prime	6	5	4	2	M/-1	○○○○○○
<input type="checkbox"/> omni	—	1	2	3	S	○○○
Shadow Cat B	5J	4	4	2	M/-1	○○○
<input type="checkbox"/> omni, ecm, prb	—	1	2	3	S	○○○
Black Hawk Prime	5J	6	5	—	M/-1	○○○○○
<input type="checkbox"/> omni	3	1	2	3	S	○○○
Loki Prime	5	5	4	2	H/-1	○○○
<input type="checkbox"/> omni, ecm, prb	3	1	2	3	S	○○○○○

ID: MH10 Name: Bravo Star

Element	MP	PB	M	L	Wt./	Armor
	OV	+0	+2	+4	Skill	
Ryoken A	6	6	5	1	M/-2	○○○○○○
<input type="checkbox"/> omni, if	2	1	2	3	S	○○○
Thor Prime	5J	5	3	3	H/-2	○○○○○○
<input type="checkbox"/> omni	—	1	2	3	S	○○○○○
Vulture Prime	5	4	4	3	H/-1	○○○○○
<input type="checkbox"/> omni	2	1	2	3	S	○○○○○
Cauldron-Born Prime	5	4	4	3	H/-2	○○○○○○
<input type="checkbox"/> omni	3	1	2	3	S	○○○○○
Thor Prime	5J	5	3	3	H/-1	○○○○○○
<input type="checkbox"/> omni	—	1	2	3	S	○○○○○

ID: MM14 Name: Charlie Star

Element	MP	PB	M	L	Wt./	Armor
	OV	+0	+2	+4	Skill	
Vulture B	5	4	4	3	H/-2	○○○○○
<input type="checkbox"/> omni	—	1	2	3	S	○○○○○
Mad Cat B	5	5	4	3	H/-2	○○○○○○○
<input type="checkbox"/> omni	—	1	2	3	S	○○○○○
Black Hawk A	5J	4	3	2	M/-1	○○○○○
<input type="checkbox"/> omni	1	1	2	3	S	○○○
Grendel Prime	7J	4	3	1	M/-1	○○○○○
<input type="checkbox"/> omni	2	1	2	3	S	○○○
Ryoken A	6	6	5	1	M/-2	○○○○○○
<input type="checkbox"/> omni, if	2	1	2	3	S	○○○○○

ID: MH11 Name: Alpha Star\*

Element	MP	PB	M	L	Wt./	Armor
	OV	+0	+2	+4	Skill	
Mad Cat Prime	5	6	4	3	H/-1	○○○○○○○
<input type="checkbox"/> omni	2	1	2	3	S	○○○○○
Vulture Prime	5	4	4	3	H/-1	○○○○○
<input type="checkbox"/>	2	1	2	3	S	○○○○○
Vulture B	5	4	4	2	H/-2	○○○○○
<input type="checkbox"/> omni	3	1	2	3	S	○○○○○
Loki Prime	5	5	4	2	H/-2	○○○
<input type="checkbox"/> omni, ecm, prb	3	1	2	3	S	○○○○○
Night Gyr Prime	4J	7	6	4	H/-1	○○○○○○○
<input type="checkbox"/> omni	1	1	2	3	S	○○○○○

ID: MH12 Name: Bravo Star

Element	MP	PB	M	L	Wt./	Armor
	OV	+0	+2	+4	Skill	
Ryoken D	6	5	4	3	M/-2	○○○○○○○
<input type="checkbox"/> omni, if	—	1	2	3	S	○○○
Vulture C	5	3	3	3	H/-1	○○○○○
<input type="checkbox"/> omni	—	1	2	3	S	○○○○○
Cauldron-Born Prime	5	4	4	3	H/-2	○○○○○○
<input type="checkbox"/> omni	—	1	2	3	S	○○○○○
Mad Cat A	5	7	6	3	H/-1	○○○○○○○
<input type="checkbox"/> omni	1	1	2	3	S	○○○○○
Masakari B	4	7	6	2	A/-1	○○○○○○○
<input type="checkbox"/> omni	—	1	2	3	S	○○○○○

ID: ML10 Name: Charlie Star

Element	MP	PB	M	L	Wt./	Armor
	OV	+0	+2	+4	Skill	
Koshi A	7	1	—	—	L/-2	○○
<input type="checkbox"/> omni, tag, prb	—	1	2	3	S	○○
Puma A	6	4	3	2	L/-1	○○○
<input type="checkbox"/> omni, if	—	1	2	3	S	○○
Puma C	6	4	3	2	L/-1	○○○
<input type="checkbox"/> omni, if	—	1	2	3	S	○○
Koshi Prime	7	2	1	1	L/-2	○○
<input type="checkbox"/> omni, if, prb	—	1	2	3	S	○○
Uller Prime	6	3	3	2	L/-2	○○
<input type="checkbox"/>	—	1	2	3	S	○○

ID: IB6 Name: Alpha Star\*

Element	MP	PB	M	L	Wt./	Armor
	OV	+0	+2	+4	Skill	
Elemental Point w/ SL	3J	2	1	—	-2	○○○
<input type="checkbox"/> car1	—	—	—	—	—	—
Elemental Point w/ SL	3J	5	4	2	-1	○○○
<input type="checkbox"/> car1	—	—	—	—	—	—
Elemental Point w/ SL	3J	4	4	2	-1	○○○
<input type="checkbox"/> car1	—	—	—	—	—	—
Elemental Point w/ MG	3J	6	5	—	-2	○○○
<input type="checkbox"/> car1	—	—	—	—	—	—
Elemental Point w/ MG	3J	2	1	—	-1	○○○
<input type="checkbox"/> car1	—	—	—	—	—	—

ID: IB7 Name: Bravo Star

Element	MP	PB	M	L	Wt./	Armor
	OV	+0	+2	+4	Skill	
Elemental Point w/ SL	3J	2	1	—	-1	○○○
<input type="checkbox"/> car1	—	—	—	—	—	—
Elemental Point w/ SL	3J	2	1	—	-2	○○○
<input type="checkbox"/> car1	—	—	—	—	—	—
Elemental Point w/ SL	3J	2	1	—	-1	○○○
<input type="checkbox"/> car1	—	—	—	—	—	—
Elemental Point w/ MG	3J	2	1	—	-2	○○○
<input type="checkbox"/> car1	—	—	—	—	—	—
Elemental Point w/ MG	3J	2	1	—	-3	○○○
<input type="checkbox"/> car1	—	—	—	—	—	—

# BATTLEFORCE<sup>®</sup> 2

## CLAN RECORD SHEET

ID: FH3 Name: Alpha Fighter Point\* Cmd: FL3

Element	MP	PB	M	L	Wt./	Skill	Armor
OV	+0	+2	+4				
Saburai Prime	6	7	6	6	H/-1		○○○○○
<input type="checkbox"/> omni	—	1	2	3	S		
Saburai Prime	6	7	6	6	H/-1		○○○○○
<input type="checkbox"/> omni	—	1	2	3	S		
<input type="checkbox"/>	—	1	2	3	S		
<input type="checkbox"/>	—	1	2	3	S		
<input type="checkbox"/>	—	1	2	3	S		

ID: FL3 Name: Bravo Fighter Star Cmd:

Element	MP	PB	M	L	Wt./	Skill	Armor
OV	+0	+2	+4				
Batu A	9	3	2	2	L/-1		○○○○○
<input type="checkbox"/> omni	—	1	2	3	S		
Batu A	9	3	2	2	L/-1		○○○○○
<input type="checkbox"/> omni	—	1	2	3	S		
<input type="checkbox"/>	—	1	2	3	S		
<input type="checkbox"/>	—	1	2	3	S		
<input type="checkbox"/>	—	1	2	3	S		

ID: MA5 Name: Alpha Artillery Point Cmd:

Element	MP	PB	M	L	Wt./	Skill	Armor
OV	+0	+2	+4				
Naga Prime	5	4	4	4	A/-1		○○○○○
<input type="checkbox"/> omni, artA	—	1	2	3	S		○○○○○
<input type="checkbox"/>	—	1	2	3	S		
<input type="checkbox"/>	—	1	2	3	S		
<input type="checkbox"/>	—	1	2	3	S		
<input type="checkbox"/>	—	1	2	3	S		

ID: \_\_\_\_\_ Name: \_\_\_\_\_ Cmd: \_\_\_\_\_

Element	MP	PB	M	L	Wt./	Skill	Armor
OV	+0	+2	+4				
<input type="checkbox"/>	—	1	2	3	S		
<input type="checkbox"/>	—	1	2	3	S		
<input type="checkbox"/>	—	1	2	3	S		
<input type="checkbox"/>	—	1	2	3	S		
<input type="checkbox"/>	—	1	2	3	S		

ID: \_\_\_\_\_ Name: \_\_\_\_\_ Cmd: \_\_\_\_\_

Element	MP	PB	M	L	Wt./	Skill	Armor
OV	+0	+2	+4				
<input type="checkbox"/>	—	1	2	3	S		
<input type="checkbox"/>	—	1	2	3	S		
<input type="checkbox"/>	—	1	2	3	S		
<input type="checkbox"/>	—	1	2	3	S		
<input type="checkbox"/>	—	1	2	3	S		

ID: \_\_\_\_\_ Name: \_\_\_\_\_ Cmd: \_\_\_\_\_

Element	MP	PB	M	L	Wt./	Skill	Armor
OV	+0	+2	+4				
<input type="checkbox"/>	—	1	2	3	S		
<input type="checkbox"/>	—	1	2	3	S		
<input type="checkbox"/>	—	1	2	3	S		
<input type="checkbox"/>	—	1	2	3	S		
<input type="checkbox"/>	—	1	2	3	S		

ID: \_\_\_\_\_ Name: \_\_\_\_\_ Cmd: \_\_\_\_\_

Element	MP	PB	M	L	Wt./	Skill	Armor
OV	+0	+2	+4				
<input type="checkbox"/>	—	1	2	3	S		
<input type="checkbox"/>	—	1	2	3	S		
<input type="checkbox"/>	—	1	2	3	S		
<input type="checkbox"/>	—	1	2	3	S		
<input type="checkbox"/>	—	1	2	3	S		

ID: \_\_\_\_\_ Name: \_\_\_\_\_ Cmd: \_\_\_\_\_

Element	MP	PB	M	L	Wt./	Skill	Armor
OV	+0	+2	+4				
<input type="checkbox"/>	—	1	2	3	S		
<input type="checkbox"/>	—	1	2	3	S		
<input type="checkbox"/>	—	1	2	3	S		
<input type="checkbox"/>	—	1	2	3	S		
<input type="checkbox"/>	—	1	2	3	S		

# BATTLEFORCE<sup>®</sup> 2

BATTLETECH WARFARE ON A GRAND SCALE

## PLANETARY ASSAULT ROSTER SHEET 1

X	Unit#	Type/Name	Exp.	X	Unit#	Type/Name	Exp.	X	Unit#	Type/Name	Exp.
	AR1				GL2				JU2		
	AR2				GL3				MA1		
	AR3				GL4				MA2		
	AR4				GL5				MA3		
	AR5				GL6				MH1		
	B1				GM1				MH2		
	B2				GM2				MH3		
	B3				GM3				MH4		
	B4				GM4				MH5		
	B5				GM5				MH6		
	B6				GM6				MH7		
	C1				GM7				MH8		
	C2				GM8				MH9		
	C3				GM9				ML1		
	C4				GM10				ML2		
	DA1				GM11				ML3		
	DH1				GM12				ML4		
	DH2				GT1				ML5		
	DL1				GT2				ML6		
	DL2				GT3				ML7		
	DL3				GT4				ML8		
	DM1				GT5				ML9		
	DM2				GT6				MM1		
	FH1				H3				MM2		
	FH2				IB1				MM3		
	FL1				IB2				MM4		
	FL2				IB3				MM5		
	FM1				IB4				MM6		
	FM2				IB5				MM7		
	FM3				IN1				MM8		
	GA1				IN2				MM9		
	GA2				IN3				MM10		
	GA3				IN4				MM11		
	GC1				IN5				MM12		
	GC2				IN6				NS1		
	GC3				IN7				NT1		
	GC4				IN8				NT2		
	GC5				IN9				NT3		
	GC6				IN10				O1		
	GC7				IN11				O2		
	GC8				IN12				SP1		
	GC9				IN13				T1		
	GC10				IN14				VA1		
	GH1				IN15				VA2		
	GH2				IN16				VA3		
	GH3				IN17				VT1		
	GH4				IN18				VT2		
	GH5				IN19				VT3		
	GH6				IN20				WH1		
	GH7				IN21				WM1		
	GH8				IN22				WM2		
	GH9				IN23						
	GL1				JU1						



# BATTLEFORCE<sup>®</sup> 2

BATTLETECH WARFARE ON A GRAND SCALE

## PLANETARY ASSAULT ROSTER SHEET 2

X	Unit#	Type/Name	Exp.	X	Unit#	Type/Name	Exp.	X	Unit#	Type/Name	Exp.
	AR6				GL8				JU4		
	AR7				GL9				MA4		
	AR8				GL10				MA5		
	AR9				GL11				MA6		
	AR10				GL12				MH10		
	B7				GM13				MH11		
	B8				GM14				MH12		
	B9				GM15				MH13		
	B10				GM16				MH14		
	B11				GM17				MH15		
	B12				GM18				MH16		
	C5				GM19				MH17		
	C6				GM20				MH18		
	C7				GM21				ML10		
	C8				GM22				ML11		
	DA2				GM23				ML12		
	DH4				GM24				ML13		
	DH5				GT7				ML14		
	DL4				GT8				ML15		
	DL5				GT9				ML16		
	DL6				GT10				ML17		
	DM3				GT11				ML18		
	DM4				GT12				MM13		
	FH3				H6				MM14		
	FH4				IB6				MM15		
	FL3				IB7				MM16		
	FL4				IB8				MM17		
	FM4				IB9				MM18		
	FM5				IB10				MM19		
	FM6				IN24				MM20		
	GA4				IN25				MM21		
	GA5				IN26				MM22		
	GA6				IN27				MM23		
	GC11				IN28				MM24		
	GC12				IN29				NS2		
	GC13				IN30				NT4		
	GC14				IN31				NT5		
	GC15				IN32				NT6		
	GC16				IN33				O3		
	GC17				IN34				O4		
	GC18				IN35				SP2		
	GC19				IN36				T2		
	GC20				IN37				VA4		
	GH10				IN38				VA5		
	GH11				IN39				VA6		
	GH12				IN40				VT4		
	GH13				IN41				VT5		
	GH14				IN42				VT6		
	GH15				IN43				WH2		
	GH16				IN44				WM3		
	GH17				IN45				WM4		
	GH18				IN46						
	GL7				JU3						

# BATTLEFORCE® 2 TABLES

## SKILL MODIFIERS TABLE

BattleTech Experience Level	BattleForce Skill Modifier
Green	+1
Regular	+0
Veteran	-1
Elite	-2

## BUILDING TABLE

Building Type	MP to Enter*	Strength	Weight Limit	Affects LOS as
Base	2	12	L, M	Clear
City	3	14	L, M, H	Light Woods
Fortress	4	16	L, M, H, A	Heavy Woods

\* Infantry only pay 1 MP to enter Building hexes.

## CRITICAL HITS TABLE

2D6 Roll	BattleMech Critical Hit	Vehicle Critical Hit	Effects
2-7	No Critical Hit	No Critical Hit	—
8	Arm Actuator Hit	Turret Hit	+1 to attack target numbers
9	Leg Actuator Hit	Wheel/Track Hit	MP - 1 (minimum 0)
10	Weapon Destroyed	Weapon Destroyed	Damage Values - 1 at all ranges (minimum 0)
11	Engine Hit	Engine Hit	+1 Heat; third hit destroys element*
12	Head Blown Off	Crew Killed	Element destroyed

\*Each engine hit increases the heat build-up from firing weapons by +1. This includes standard attacks as well as attacks made while overheating. Elements that cannot overheat suffer no heat build-up, but the third engine hit still destroys the element.

## MOVEMENT COST TABLE

Terrain Type	MP Cost Per Hex	Prohibited Units*
Clear	1	naval, submarine
Road/Paved/Bridge	1**	naval, submarine
Rough/Rubble	2	naval, submarine, wheeled
Light Woods	2	hover, naval, submarine, wheeled
Heavy Woods	3	hover, naval, submarine, tracked, wheeled
Water	3***	infantry, tracked, wheeled
Elevation Change	+1 per level	—
Base	2	naval, submarine
City	3	naval, submarine
Fortress	4	naval, submarine

\*See the Forces section (p. 7) for more information on the movement of elements other than 'Mechs.

\*\*If traveling along road; otherwise, use the MP cost of the underlying terrain.

\*\*\*Water costs only 1 MP per hex for hover, naval and submarine units.

Infantry pay only 1 MP to enter Building hexes.

## SEQUENCE OF PLAY

### 1. Initiative Phase

### 2. Player Phases

- First Player Phases**  
 2a. Command Phase  
 2b. Movement Phase  
 2c. Combat Phase  
**Second Player Phases**  
 2d. Command Phase  
 2e. Movement Phase  
 2f. Combat Phase

### 3. End Phase

## ATTACK MODIFIER TABLE

Target's MP	Base To-Hit Number
0-2	4
3-4	5
5-6	6
7-9	7
10+	8
Range	Modifier
Pointblank	+0
Medium	+2
Long	+4
Target Modifier	
can Jump	+1
is battle armor	+1
is in Light Woods or City	+1
is in Heavy Woods or Fortress	+2
is in Water	-1
Attacker	Modifier
is in Water	+1
has exceptional Skill	+ (Skill Modifier)
has Overheated	+ (Heat Level)
is using Indirect Fire	+1
Has critical damage	see p. 26

## BASIC COMMAND LIST: INNER SPHERE

- 1 Alpha Strike!
- 2 Ambush
- 3 Charge!
- 4 Doubletime March
- 5 Evasive Action
- 6 Hello, HQ?
- 7 Luck of the Fox
- 8 Stand and Shoot
- 9 Careful Aim
- 10 Careful Aim

## BASIC COMMAND LIST: CLAN

- 11 Alpha Strike!
- 12 Alpha Strike!
- 13 Doubletime March
- 14 Evasive Action
- 15 Hello, HQ?
- 16 Luck of the Fox
- 17 Stand and Shoot
- 18 Stand and Shoot
- 19 Careful Aim
- 20 Careful Aim

## COMMAND SUMMARY TABLE

Command	MP	Attacks	Other Effects
Alpha Strike!	—	—	Add +1 to the Overheat Values of the entire unit
Ambush**	—	—	<b>Hidden:</b> Reveal after opponent moves; may attack during opponent's turn*
Careful Aim	No Jump	-1	—
Charge!	—	—	One element in unit may make a Charging attack*
Death from Above	—	—	One Jumping element in unit may make a Death-from-Above attack*
Doubletime March	+1	+1	—
Evasive Action	—	No attacks	<b>Hidden:</b> Reveal after attack is declared on unit; all attacks against unit suffer a +2 To-Hit Modifier
Fall Back!	+2	+2	Affects all subordinate units; no subordinate unit may move closer to enemy units*
Hello, HQ?*	No Move	—	<b>Negative</b>
Jam Transmission**	—	—	<b>Hidden:</b> Negate effects of one enemy command*
Luck of the Fox	—	—	<b>Hidden:</b> Reveal at any time; unit may make a single re-roll or force opponent to re-roll once
Stand and Shoot	No Move	-2	—

\*See additional rules on p. 28.

\*\*Special Command: counter is set aside for a turn rather than being returned to cup immediately after use.

# PLANETARY ASSAULT TABLES

## COMBINED UNIT REFERENCE TABLE

UNIT TYPE	Counter ID	MP	Attack	Defense	Toughness	Transport
<b>BattleMech Units</b>						
Light 'Mech Co (IS)	ML	3	1	8	6	—
Med 'Mech Co (IS)	MM	2	2	6	8	—
Hvy 'Mech Co (IS)	MH	1	3	5	10	—
Assault 'Mech Co (IS)	MA	1	4	4	12	—
Light 'Mech Co/Binary (IU/C2)	ML	4	1	8	5	—
Med 'Mech Co/Binary (IU/C2)	MM	3	2	7	7	—
Hvy 'Mech Co/Binary (IU/C2)	MH	2	4	6	9	—
Assault 'Mech Co/Binary (IU/C2)	MA	1	6	4	11	—
Light 'Mech Trinary (C2)	ML	4	2	7	6	**
Med 'Mech Trinary (C2)	MM	3	3	6	8	**
Hvy 'Mech Trinary (C2)	MH	2	6	5	10	**
Assault 'Mech Trinary (C2)	MA	1	8	3	12	**
Light 'Mech Binary (C1)	ML	4	2	8	5	—
Med 'Mech Binary (C1)	MM	3	3	7	7	—
Hvy 'Mech Binary (C1)	MH	2	5	6	9	—
Assault 'Mech Binary (C1)	MA	1	7	4	11	—
Light 'Mech Trinary (C1)	ML	4	3	7	6	—
Med 'Mech Trinary (C1)	MM	3	5	6	8	—
Hvy 'Mech Trinary (C1)	MH	2	7	5	10	—
Assault 'Mech Trinary (C1)	MA	1	9	3	12	—
Light Supernova Binary (C1)	ML	4	5	8	6	—
Med Supernova Binary (C1)	MM	3	6	7	8	—
Hvy Supernova Binary (C1)	MH	2	8	6	10	—
Assault Supernova Binary (C1)	MA	1	9	4	12	—
Light Supernova Trinary (C1)	ML	4	7	6	7	**
Med Supernova Trinary (C1)	MM	3	9	5	9	**
Hvy Supernova Trinary (C1)	MH	2	11	4	11	**
Assault Supernova Trinary (C1)	MA	1	13	3	13	**
<b>Ground Vehicle Units</b>						
Light Vehicle Co	GL	4	2	7	3	—
Med Vehicle Co	GM	3	4	6	5	—
Hvy Vehicle Co	GH	1	6	5	7	—
Assault Vehicle Co	GA	1	8	3	9	—
Supply Convoy	GC	2	0	5	4	—
Ground Trans Co/Binary	GT	2	2	6	5	2
Ground Trans Trinary	GT	2	3	5	6	3**
Artillery Co/Binary	AR	1	4*	3	3	—
Artillery Trinary	AR	1	6*	3	4	**
<b>VTOL Units</b>						
Attack VTOL Co	VA	5	2	9	4	—
Air Trans Co/Binary	VT	4	1	6	4	1
Air Trans Trinary	VT	3	2	5	5	2**
<b>Naval Units</b>						
Naval Trans Co/Binary	NT	2	2	5	6	3
Naval Trans Trinary	NT	2	3	4	7	5
Submarine Co	NS	2	6	4	7	—
<b>Infantry Units</b>						
Infantry Bn/Binary	IN	1	2	3	7	—
Infantry Trinary	IN	1	3	3	8	**
Battle Armor Co (IS)	IB	1	3	4	8	—
Battle Armor Binary (C1)	IB	1	4	4	9	—
Battle Armor Trinary (C1)	IB	1	6	3	10	**
<b>Aerospace Fighter Units</b>						
Light Fighter Sqd (IS)	FL	8	2	10	5	—
Med Fighter Sqd (IS)	FM	7	4	9	7	—
Hvy Fighter Sqd (IS)	FH	6	6	8	9	—
Light Fighter Sqd/Star (IU/C2)	FL	8	3	10	4	—
Med Fighter Sqd/Star (IU/C2)	FM	7	5	9	6	—
Hvy Fighter Sqd/Star (IU/C2)	FH	6	7	8	8	—
Light Fighter Star (C1)	FL	8	4	10	5	—
Med Fighter Star (C1)	FM	7	6	9	7	—
Hvy Fighter Star (C1)	FH	6	8	8	9	—
<b>DropShip Groups (3 DropShips per group)</b>						
DropShip Group (Sm Trans)	DL	6	3	8	10	3
DropShip Group (Med Trans)	DM	5	4	6	11	6
DropShip Group (Lg Trans)	DH	4	6	4	12	9
DropShip Group (Assault)	DA	6	6	6	10	—
<b>JumpShip</b>	JU	0	0	3	8	—
<b>WarShips</b>						
Small WarShip	WM	3	10*	5	13	—
Large WarShip	WH	2	12*	4	14	—
<b>Space Station</b>	SP	0	2	2	10	—
<b>Settlements</b>						
Fortress	T	0	4*	2	14	—
City	C	0	0	2	12	—
Base	B	0	2	2	8	—

\*This unit can attack non-adjacent units. See **Planetary Combat**, p. 84.

\*\*Trinary units count as two units when being carried by transports and DropShips.

## TO-HIT MODIFIERS TABLE

Condition	Modifier
<b>Attacker</b>	
Quality Rating	
Green	+1
Regular	+0
Veteran	-1
Elite	-2
Out of Supply	+2
Damaged	+2
On Target's Flank	-1
On Target's Rear	-2
Harassed (enemy units adjacent to attacker)	+1 per unit
<b>Target</b>	
Damaged	-2
Out of Supply	-1
Harassed (enemy units adjacent to target)	-1 per unit
<b>Target's Terrain*</b>	
Arctic	-1
Base	+1
City	+2
Plains	+0
Desert	-1
Forest/Jungle	+2
Fortress	+3
Mountains	+3
Water	-2

\*Double these modifiers for infantry units, whether the result is good or bad for the unit. Terrain modifiers are not cumulative; use the single highest applicable modifier only.

## DAMAGE ROLL MODIFIERS TABLE

Condition	Modifier
<b>Attacker</b>	
Attack Rating	+Rating
Out of Supply	-2
Damaged	-2
On Target's Flank	+2
On Target's Rear	+4
Harassed (enemy units adjacent to attacker)	-1 per unit
Arctic Terrain*	+1
Desert Terrain*	-1
<b>Target</b>	
Damaged	+2
Out of Supply	+1
Harassed (enemy units adjacent to target)	+1 per unit

\*This modifier applies to BattleMechs only.

## BATTLE BOARD TERRAIN TABLE

Shaded Terrain	Outlying Terrain
Arctic	Arctic
Desert	Desert
Woods	Plains
Mountains	Woods
Plains	Plains
Space	Space
Water	Water
Island Hex	
Primary*	Water
Lake Hex	
Water	Primary*

\*For Island and Lake hexes, the primary terrain feature is whatever non-water terrain is in the hex. For example, if the land in an Island hex is wooded, then the shaded boxes are considered Woods terrain, surrounded by water. If the land surrounding a lake is wooded, then the outlying terrain is Woods.

## PLANETARY TERRAIN TABLE

Terrain Type	MP Cost	Prohibited Units
Plains	1	Naval*
Woods	2 (3)	Naval*
Mountains	3 (4)	Naval*
Desert	2	Naval*
Arctic	2	Naval*
Water	1	BattleMech, Ground Vehicle, Infantry**

Aerospace and VTOL units pay 1 MP per hex regardless of terrain. The MP cost in parentheses applies to ground vehicle units only (see **Unit Reference Tables**, p. 75).

\*Naval units can occupy these hexes as long as there is some water in the hex.

\*\*Ground units can occupy these hexes as long as there is some land in the hex.

# MECHFORCE®

## NORTH AMERICA

### MEMBERSHIP APPLICATION

(Please use a pen and print clearly)

Name: \_\_\_\_\_

Street Address: \_\_\_\_\_

City: \_\_\_\_\_ State: \_\_\_\_\_ Zip: \_\_\_\_\_

Phone: ( \_\_\_\_\_ ) \_\_\_\_\_ Country \_\_\_\_\_

**Please check one Unit Affiliation:**

- |  |  |
|--|--|
| <input type="checkbox"/> •Bandit Kingdoms          | <input type="checkbox"/> •Clan Smoke Jaguar  |
| <input type="checkbox"/> •Capellan Confederation   | <input type="checkbox"/> •Clan Ghost Bear    |
| <input type="checkbox"/> •Draconis Combine         | <input type="checkbox"/> •Clan Diamond Shark |
| <input type="checkbox"/> •Federated Commonwealth   | <input type="checkbox"/> •Clan Jade Falcon   |
| <input type="checkbox"/> •Free Rasalhague Republic | <input type="checkbox"/> •Clan Steel Viper   |
| <input type="checkbox"/> •Free Worlds League       | <input type="checkbox"/> •Clan Wolf          |
| <input type="checkbox"/> •Lyran Alliance           | <input type="checkbox"/> •Clan Nova Cat      |
| <input type="checkbox"/> •Magistracy of Canopus    | <input type="checkbox"/> •ComStar            |
| <input type="checkbox"/> •Mercenary                | <input type="checkbox"/> •St. Ives Compact   |
| <input type="checkbox"/> •Periphery Independent    | <input type="checkbox"/> •Taurian Concordat  |
| <input type="checkbox"/> •Outworlds Alliance       | <input type="checkbox"/> •Word of Blake      |

### MEMBERSHIP OPTIONS

**FULL MEMBERSHIP • \$20.00**

- Full membership includes:
- Four issues of MechForce Quarterly
  - An official MechForce Membership Kit
  - Membership card and dog tag with ID number
  - MechForce Manual with Ranking material
  - BattleTech poster and FASA catalog
  - 10% discount on FASA products at conventions that FASA attends

**ASSOCIATE MEMBERSHIP • \$5.00**

- Associate membership includes:
- A MechForce Membership ID card
  - MechForce Manual with Ranking material
  - BattleTech poster and FASA catalog
  - 10% discount on FASA products at conventions that FASA attends

**Please sign me up for the following:**

**NEW MEMBERSHIP**    **RENEWAL**   ID# \_\_\_\_\_

**I have enclosed my membership fee of:**

**\$20.00 FULL**    **\$5.00 ASSOCIATE**

CREDIT CARD:    Visa    MasterCard    Discover

Card Number

--	--	--	--	--	--	--	--	--	--	--	--	--	--	--	--	--	--	--	--	--	--	--

Name of Cardholder (please print)   *Card Expiration date*

Cardholder Signature

### CHAPTER INFORMATION

- If you are renewing your MechForce membership and you are currently a Chapter member, please provide us with your Chapter name

- If you are applying for membership in MechForce for the first time, and you are interested in joining or forming a Chapter, please contact MechForce at the address below for more information.

**FULL MEMBERSHIPS — PLEASE INCLUDE ADDITIONAL POSTAGE IF OUTSIDE THE USA**

- Canada & Mexico .....\$ 5.00
- Other International .....\$10.00

Total Amount Enclosed.....\$

**Send To:**  
**FASA Corporation**  
**Attention: MechForce**  
**1100 W. Cermak, B305**  
**Chicago, IL 60608**

**Make all Checks/Money Orders payable to FASA CORPORATION in United States dollars only (please allow 4 to 6 weeks for initial kit delivery) DO NOT SEND CASH**

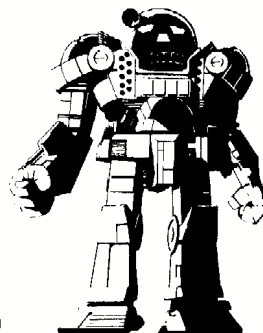

.....FLASH MESSAGE.....

# BATTLETECH

wages war on the check writing battleground. And now you can  
Blast your bills and other payments with your very own....

## BATTLETECH CHECKS!

© 1995 FASA, Inc. Registered Trademark of FASA International, Inc.

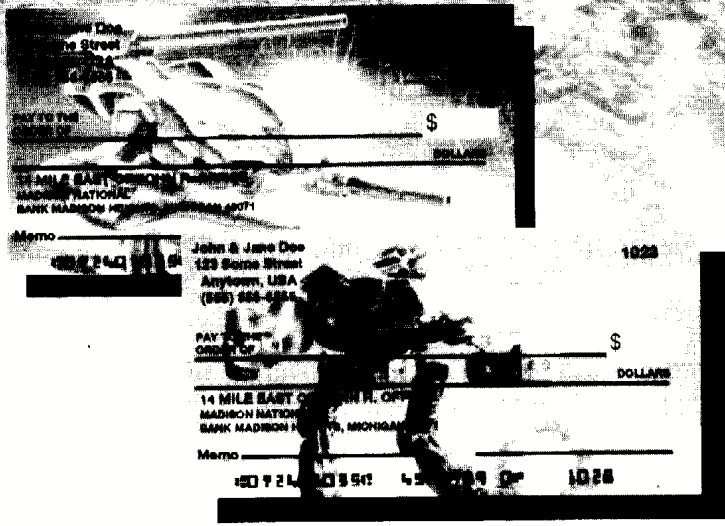

It's easy to order your BattleTech Checks! Here's How:

1. Enclose a reorder/order form and a voided check (if paying by money order) plus a deposit slip from the current account, noting any changes.
2. Complete the order form below and include with all items.
3. Enclose check or money order payable to Impressive Images and mail to:  
FASA Processing Center • P.O. Box 2177 • Farmington Hills, MI 48334

**You Can Call Us  
With Any Questions!  
1-888-436-6179  
(Toll Free)**

**Completely Confidential! All Checks Have Security Features! Money Back Guarantee!**

### ORDER FORM

Daytime Phone: (     ) \_\_\_\_\_  
Name: \_\_\_\_\_  
Starting Check # \_\_\_\_\_ (1001, if not specified)

**Singles (200/box) #BC200s     \$15.75**  
**Duplicates (150/box) #BC150d   \$17.75**

Amount for checks	
Custom Lettering	
Standard Script Italics	FREE!
Shipping & Handling Add \$1.75/Box	
SUBTOTAL	
Sales Tax	
MI Residents Only Add 6%	
(Optional)	
In-Plant Rush Add \$2.50	
(Optional)	
Overnight Delivery Add \$10.75	
TOTAL AMOUNT	



**FASA**  
CORPORATION